



2019 Global Product Catalog





KYOCERA SGS Precision Tools (KSPT) is an ISO-certified manufacturer of industry leading round solid carbide cutting tools. State of the art manufacturing and warehouse facilities have the capacity and processes to meet the quality and delivery demands of customers in all markets around the world. Complete inspections performed within its metallurgical lab and manufacturing quality departments ensure the use of high quality carbide and reliable manufacturing consistency regardless of when a cutting tool is produced.

KSPT is proud to have pioneered some of the world's most advanced cutting technologies due to rigorous testing of tools, coatings, and materials within its Global Innovation Center. It is this commitment to innovation that has launched patented products and technologies like the Z-Carb with its variable geometry and cutting edge preparation, Series 43 APR® and APF® ultra high performance aluminum cutting tools, and the JetStream coolant technology.

SGS has become an important part of the KYOCERA PrecisionTools family, and while the name has changed, one thing has not. Its dedicated people and their relentless commitment to the customer. KSPT Technical Sales Engineers, Application Specialists, and Distribution Partners blanket the globe, delivering reliable service and support to all market segments. It is these people and products that drive innovative application strategies and cutting tool technologies into the end user, continually exceeding expectations and providing the most Value at the Spindle®.



Table of Contents

KYOCERA SGS Precision Tools	2
KYOCERA SGS Precision Tools Europe Ltd. . .	4
Global Innovation Center	5
Tooling Services.....	6
Tech Hub	7
Medical Divison	8
Tool Wizard®	9

OVERVIEW

Common Legend.....	10
End Mill Legend.....	12
Drill Legend.....	13
Router Legend	14

COATINGS	15
----------------	----

MILLING

High Performance End Mills.....	16
End Mill Matrix.....	22
High Performance Aluminum End Mills . . .	118
General Purpose End Mills.....	170

HOLE MAKING

High Performance Drills	238
General Purpose Drills	298
General Purpose Countersinks	324
General Purpose Reamers	340

ROUTING

High Performance Routers.....	352
General Purpose Routers	370

TECHNICAL INFORMATION

EDP Index	376
KSPT Reference Information	393
Decimal Equivalent Chart	394
Hardness Conversion Chart	395





MORE THAN JUST ANOTHER CUTTING TOOL SUPPLIER

KYOCERA SGS PRECISION TOOLS EUROPE, LTD.

The state of the art KYOCERA SGS Precision Tools Europe facility is located in Wokingham, England and is focused on the manufacture of special cutting tools, high accuracy form tools, tool modifications and regrinds. A highly skilled team of professionals specialize in the supply and support of high performance tools for the Aerospace, Medical, Power Generation and Motorsport markets.

KYOCERA SGS Precision Tools Europe also offers a full range of end mill and drill products as follows:

- Multi-Million Euro Warehouse Stocking Full Range of Catalog Products
- Same Day Shipment on Stock Items
- Multi-Lingual Sales and Technical Support
- Online Portal for Stock Availability, Pricing, Discount Information and 24-Hour Order Placement
- High Performance Product and Application Training, Including the New KYOCERA SGS Tool Clinic

Additional services provided at this facility include:

- A Fast Track for Special Tools Via Our Rapid Response Centre
- Product Research and Development
- Product Engineering and Tool Application Support
- CAD/CAM Software Support





GLOBAL INNOVATION CENTER

INNOVATIVE CUTTING TOOL TECHNOLOGIES

The Global Innovation Center is an environment conducive to innovation. Through testing and development, the dedicated KYOCERA SGS Precision Tools Team focuses on the latest technical competence and machining techniques to bring a continuous stream of new products and advancements to market.

- Cutting Edge Equipment
- Highly Engineered Technology
- Incorporation of innovative machine tool technology for Research and Development

TECHNICAL TRAINING & EDUCATION

Our knowledge-based selling programs are specifically designed to challenge and educate by facilitating programs that mix classroom presentation with hands-on experience. Our own KSPT team members go through the same core training we provide to our valued distribution partners.

- KSPT Campus Tool Clinics
- On-Site Customer Training
- Basic, Advanced and Expert Level Material
- Market-Driven Knowledge

APPLICATION ENGINEERING

The KSPT expertise and global market knowledge allows us to translate customer needs into a commercial sales strategy. The portfolio of KSPT products and services offer an unparalleled track record in performance, cost savings, quality and value at the spindle.

- Market-Driven Productivity Improvements, including the Z-Carb HPR and S-Carb APR/APF®
- Tooling Solutions which include development of new tool geometries, extreme lab testing parameters and extensive field testing
- Technical Support and Troubleshooting
- Research and Development



TOOLING SERVICES

KSPT is committed to providing superior tooling services in the areas of Reconditioning, Recoating, Regrinding, Specials and Alterations. These services are offered to provide unique solutions and enhanced tool life with involvement from the KSPT Technical Support Team.

KSPT proudly offers Tooling Services in North America and Europe.



KSPT TOOLING SERVICES FACILITIES

UNITED STATES OF AMERICA KSPT

P.O. Box 187
55 South Main Street
Munroe Falls, Ohio 44262 U.S.A.
customer service -
US and Canada: (330) 686-5700
fax - US & Canada: (800) 447-4017
international fax: (330) 686-2146

KSPT

1021 N. Shephard Street
Anaheim, California 92806
phone: (714) 632-3000
fax: (714) 632-3003

EUROPE KSPTE

10 Ashville Way
Wokingham, Berkshire
RG41 2PL England
phone: (44) 1189-795-200
fax: (44) 1189-795-295
e-mail: SalesEU@kyocera-sgstool.com

KYOCERA SGS Precision Tools Tech Hub

149 Slayton Avenue
Danville, VA 24540
US and Canada: (434) 791-2020
Fax US & Canada: (434) 791-2044
web: www.kyocera-techhub.com

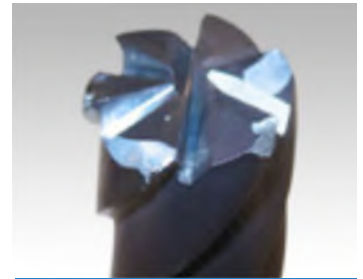

BEFORE



AFTER

TECH HUB

The KYOCERA SGSTech Hub (KSTH) is an independent subsidiary of the Kyocera SGS PrecisionTools (KSPT) group created to focus on custom cutting tool solutions and explore new technologies. This facility has resources designed to provide MORE than a cutting tool, but a complete scope of services to include managing the entire cutting tool application from conception to application and beyond.

CUSTOMIZED ENGINEERING SOLUTIONS

At KSTH we approach each opportunity as a project and manage it as such. We pride ourselves on engineering each project to the specific needs of our customers. Providing quotes often within 24 hours and following through with detailed drawings, solid models, process plans, and program simulations if needed. Our goal is to work hand in hand with the end user and maintain constant communication to customize our support to their needs.

RELEVANT TESTED SOLUTIONS

KSTH R&D has been created with a dual purpose. First and foremost is to create dedicated resources for testing and evaluating application solutions tailored to each customer project. The second is to focus on evaluating technologies within industry as a whole so that we can provide complete and relevant solutions to our customers. The KSTH R&D space is a collaborative think tank that allows KSTH to work for each customer individually with industry partners, new technology, and Universities to provide thorough next level solutions.

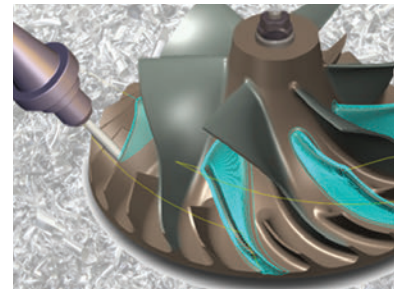
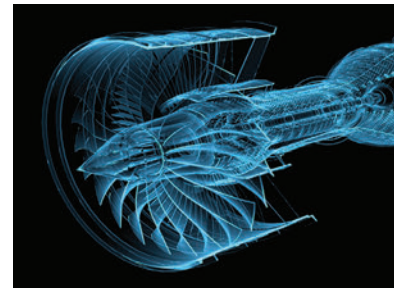

KYOCERA SGS
Precision Tools Tech Hub
149 Slayton Avenue
Danville, VA 24540
US and Canada: (434) 791-2020
Fax US & Canada: (434) 791-2044
web: www.kyocera-techhub.com





MEDICAL DIVISION

WHO WE ARE

With over 20 years of industry experience, KSPT Medical produces unique, customer designed orthopedic devices using highly trained engineers dedicated to new technology. KSPT Medical is a division of KYOCERA SGS Precision tools—an ISO-certified leader, who proudly pioneered some of the world's most advanced metal cutting technology and sells to more than 60 countries. With over 20 years of industry experience, KSPT Medical Division maintains their ISO13485 certification and is FDA Registered in the production of medical devices in the orthopedic marketplace.

ENGINEERING

We approach each opportunity as a project and manage it as such. We pride ourselves on engineering each project to the specific needs of our customers. Providing quotes often within 24 hours and following through with detailed drawings, solid models, process plans, and program simulations if needed. Our goal is to work hand in hand with the end user and maintain constant communication to customize our support to their needs.

MACHINING CAPABILITIES

- GRINDING
- MILLING
- TURNING
- PROFILING
- BENDING
- CUSTOMIZED ASSEMBLY
- Services Offered; Welding, Various Coatings, Anodizing, Passivation, Electropolishing, Laser Etching and Heat Treating



KYOCERA SGS

Precision Tools Medical Division

724 East Swihart Street
Columbia City, Indiana 46725
phone: (260) 244-7677
fax: (260) 244-7466

To Request a Quote:
rfq@kyocera-sgstool.com

Customer Service and Orders:
salesmd@kyocera-sgstool.com



ISO 13485 CERTIFIED



USE THE TOOLWIZARD® TO:

- Calculate application parameters
- Search the KSPT catalog
- Select products based on machining needs

TO SIGN UP FOR THE TOOLWIZARD®:

1. Visit www.kyocera-sgstool.com
2. Sign up for an account
3. Start calculating
4. Start saving



 **Common Legend**
 **Leyenda habitual**
 **Légende commune**
 **Gemeinsame Legende**

TO ORDER: Please specify quantity and EDP number.

PARA SU PEDIDO: Por favor especifique cantidad y número de EDP.

POUR COMMANDER: Veuillez préciser la quantité et le code article EDP.

BESTELLEN: Bitte Menge und EDV-Nummer angeben.

RETURN POLICY: An RMA number must accompany all product returns.
Contact your Customer Service Representative for an RMA number.

DEVOLUCIONES: Todo material devuelto debe ir acompañado de un número de RMA correspondiente.
Para solicitarlo, póngase en contacto con su Representante de Servicio.

POLITIQUE DE RETOUR: Tous les produits retournés doivent être accompagnés d'un numéro RMA.
Contacter votre interlocuteur commercial pour obtenir un numéro RMA.

RÜCKNAHMEGARANTIE: Eine RMA-Nummer (Rücksendegenehmigung) muss bei allen Produktrücksendungen beiliegen.
Wenden Sie sich bitte an Ihren Kunden Kundendienstmitarbeiter für RMA-Nummer.

REGULATION SAFETY GLASSES SHOULD ALWAYS BE WORN WHEN USING HIGH-SPEED CUTTING EQUIPMENT

DEBEN USARSE GAFAS PROTECTORAS CUANDO SE UTILIZA UN EQUIPO DE ALTA VELOCIDAD

DES LUNETTES DE SÉCURITE DOIVENT ÊTRE IMPÉRATIVEMENT PORTÉES LORS D'UTILISATION D'OUTILS À GRANDE VITESSE

BEI SCHNELL LAUFENDEN SPANABHEBENDEN MASCHINEN MÜSSEN IMMER DIE VORGESCHRIEBENEN SICHERHEITSBRILLEN GETRAGEN WERDEN



WARNING: This product can expose you to chemicals including Cobalt, which is known to the State of California to cause cancer. For more information go to www.p65warnings.ca.gov



ADVERTENCIA: Este producto puede exponerlo a químicos como el Cobalto, que se conoce al estado de California como causante de Cancer. Para más información vaya a esta página web: www.p65warnings.ca.gov



ATTENTION: Ce produit vous expose aux produits chimiques incluant le Cobalt, qui est reconnu par l'Etat de Californie a être une cause de cancer. Pour plus d'information veuillez regarder sur: www.p65warnings.ca.gov



WARNUNG: Dieses Produkt kann Sie Chemikalien wie Kobalt aussetzen, das dem Staat Kalifornien als krebserregend bekannt ist. Für weitere Informationen, besuchen Sie: www.p65warnings.ca.gov

INTELLECTUAL PROPERTY
PROPIEDAD INTELECTUAL
PROPRIÉTÉ INTELLECTUELLE
GEISTIGES EIGENTUM

KYOCERA SGS Precision Tools holds more than 12 patents globally. Please visit our website at www.kyocera-sgstool.com to learn more.

KYOCERA SGS Precision Tools posee más de 12 patentes a nivel mundial. Para más información, visita nuestra página web www.kyocera-sgstool.com.

KYOCERA SGS Precision Tools possède plus de 12 brevets mondialement reconnus. Pour plus d'information, veuillez consulter notre site web www.kyocera-sgstool.com.

KYOCERA SGS Precision Tools besitzt mehr als 12 Patente weltweit. Bitte besuchen Sie unsere Webseite www.kyocera-sgstool.com für weitere Informationen.

Common Legend

Leyenda habitual

Légende commune

Gemeinsame Legende

MATERIALS MATERIALES MATÉRIAUX WERKSTOFFE



Steels
Aceros
Aciers
Stähle



Stainless Steels
Aceros Inoxidables
Inox
Nichtrostende Stähle



Cast Iron
Hierro Fundido
Fonte
Grauguss



High Temp Alloys
Aleaciones a Altas Temperaturas
Alliages Haute Temp
Warmfeste Legierungen



Titanium
Titanio
Titane
Titan



Non-Ferrous
No Férrico
Non Ferreux
Nichteisenmetalle



Plastics/Composites
Plásticos/Resinas
Plastiques/Composites
Kunststoffe/Verbundkunststoffe



Hardened Steels
Aceros Endurecidos
Aciers Trempés
Gehärteter Stahl

TOOL LENGTH LONGITUD FRESA LONGUEUR DE L'OUTIL WERKZEUGLÄNGE



Stub
Corta
Court
Kurze Bauform



Regular
Media
Moyen
Standard



Long
Larga
Long
Lang



Long Reach Neck
Larga con cuello
Gorge de dégagement
longue portée
Weiter Ansatz



Extra Long
Extra-larga
Extra-long
Extra-Long

FLUTES FILOS GOUJURES SCHNEIDEKANTEN



2 Flutes
2 Filos
2 Goujures
2 Schneidekanten



3 Flutes
3 Filos
3 Goujures
3 Schneidekanten



4 Flutes
4 Filos
4 Goujures
4 Schneidekanten



5 Flutes
5 Filos
5 Goujures
5 Schneidekanten



6 Flutes
6 Filos
6 Goujures
6 Schneidekanten



7 Flutes
7 Filos
7 Goujures
7 Schneidekanten



8 Flutes
8 Filos
8 Goujures
8 Schneidekanten



9 Flutes
9 Filos
9 Goujures
9 Schneidekanten



10 Flutes
10 Filos
10 Goujures
10 Schneidekanten



11 Flutes
11 Filos
11 Goujures
11 Schneidekanten



12 Flutes
12 Filos
12 Goujures
12 Schneidekanten

 **End Mill Legend**
 **Leyenda fresas**
 **Légende fraise**
 **Fräser-Legende**

END CONFIGURATIONS
CONFIGURACIONES DE LA PUNTA
CONFIGURATIONS TERMINALES
ENDENAUSFÜHRUNG



Ball
Esférica
Boule
Kugelkopf



Corner
Plana con
borde romo
Coin
Ecke



Square
Plana
Carrée
Ohne Eckenradius

SHANK TYPE
TIPO DE VÁSTAGO
TYPE DE TIGE
SCHAFTART



Common
Normal
Commune
Standard



Straight
Recto
Droite
Gerade



Weldon Flat
Weldon plano
Méplat Weldon
Spannfläche

HELIX ANGLES
ÁNGULOS HELICOIDALES
SPANWINKEL
ANGLES DE L'HÉLICE



Right Spiral
Espiral sentido
derecho
Spirale droite
Rechtsläufig



Left Spiral
Espiral sentido
izquierdo
Spirale gauche
Linksläufig



Variable Right Spiral
Espiral sentido derecha
con ángulo variable
Spirale droite variable
Rechtsläufig, variabel

COOLANT OPTIONS
OPCIONES DE REFRIGERACIÓN
OPTIONS DE REFRROIDISSEMENT
KÜHLSCHMIERMITTEL-OPTIONEN



Internal Coolant
Refrigerante interno
Refrroidissement interne
Innenkühlung



JetStream Coolant Slots
Ranuras del refrigerante
JetStream
Fentes de refroidissement
JetStream
Kühlmittelschlitz

RAKE ANGLE
ÁNGULO DE ATAQUE
ANGLE DE PENTE
SPANWINKEL



Positive
Positivo
Positif
Positiv



Neutral
Neutro
Neutre
Neutral



Negative
Negativo
Négatif
Negativ



Variable
Variable
Variable
Variabel

ADDITIONAL GEOMETRY
CARACTERÍSTICAS GEOMÉTRICAS ADICIONALES
GÉOMÉTRIE SUPPLÉMENTAIRE
WEITERE BAUFORMEN



Flute Spacing Unequal
Espaciado filos desigual
Espacement inégal
entre les goujures
Nutenabstand Ungleich



Chip Breaker
Rompevirutas
Brise-copeaux
Spanteiler

All tools are in Right Cut Direction unless noted
 Todas las herramientas son con corte a la derecha a menos que se indique lo contrario
 Tous les outils ont une coupe à droite, sauf indications contraires
 Alle Werkzeuge schneiden rechtsdrehend, soweit nicht anders angegeben

Drill Legend

Leyenda taladros

Légende perçage

Bohrer-Legende

SHANK TYPE TIPO DE VÁSTAGO TYPE DE TIGE SCHAFTART



Common
Normal
Commune
Standard



Straight
Recto
Droite
Gerade

REACH ALCANCE LONGUEUR NUTENLÄNGE

3xD

>3xD Reach
Alcance >3xD
>Longueur 3xD
>3xD Nutenlänge

5xD

5xD Reach
Alcance 5xD
Longueur 5xD
5xD Nutenlänge

8xD

8xD Reach
Alcance 8xD
Longueur 8xD
8xD Nutenlänge

HELIX ANGLES ÁNGULOS HELICOIDALES ANGLES DE L'HÉLICE SPANWINKEL



Right Spiral
Espiral sentido derecho
Spirale droite
Rechtsläufig



None
Ninguno
Aucun
Ohne

COOLANT OPTIONS OPCIONES DE REFRIGERACIÓN OPTIONS DE REFRROIDISSEMENT KÜHLSCHMIERMITTEL-OPTIONEN



Internal Coolant
Refrigerante externo
Refrroidissement interne
Innenkühlung



External Coolant
Refrigerante interno
Refrroidissement
externe
Außenkühlung

 **Router Legend**
 **Leyenda ranuradores**
 **Légende détourage**
 **Oberfräsen-Legende**

SHANK TYPE
TIPO DE VÁSTAGO
TYPE DE TIGE
SCHAFTART



Straight
 Recto
 Droite
 Gerade

RAKE ANGLE
ÁNGULO DE ATAQUE
ANGLE DE PENTE
SPANWINKEL



Positive
 Positivo
 Positif
 Positiv



Neutral
 Neutro
 Neutre
 Neutral



Negative
 Negativo
 Négatif
 Negativ



Variable
 Variable
 Variable
 Variabel

HELIX ANGLES
ÁNGULOS HELICOIDALES
ANGLES DE L'HÉLICE
SPANWINKEL



Right Spiral
 Espiral sentido derecho
 Spirale droite
 Rechtsläufig



Left Spiral
 Espiral sentido izquierdo
 Spirale gauche
 Linksläufig

ADDITIONAL GEOMETRY
CARACTERÍSTICAS GEOMÉTRICAS ADICIONALES
GÉOMÉTRIE SUPPLÉMENTAIRE
WEITERE BAUFORMEN



Left Hand Cut Direction
 Fresado sentido
 izquierda
 Coupe vers la gauche
 Rechtsschneidend



Right Hand Cut Direction
 Fresado sentido
 derecha
 Coupe vers la droite
 Linksschneidend



Chip Breaker
 Rompevirutas
 Brise-copeaux
 Spanteiler

Ti-NAMITE® and Di-NAMITE® Tool Coatings are specifically engineered for KSPT solid carbide rotary tools. The coating lineup includes proprietary processes that result in optimized tool life and increased speed and feed rates in a variety of applications.



	Coating	Identifying Color	Layer Structure	Thickness	Hardness (HV)	Coefficient of Friction (Fretting)	Thermal Stability	General Information
	Titanium Nitride (TiN)	gold	Multilayer	1–4 microns	2200	0.4–0.65	600°C / 1112°F	A general purpose coating with good adhesion and abrasion resistant properties. Suitable for a wide variety of materials.
	Aluminum Titanium Nitride (AlTiN)	dark grey	Nano structure	1–4 microns	3700	0.30	1100°C / 2010°F	Excellent thermal and chemical resistance allows for dry cutting and improvements in performance of carbide. The coating has a high hardness giving great protection against abrasive wear and erosion.
	Titanium DiBoride (TiB2)	light grey-silver	Monolayer	1–2 microns	4000	0.45	850°C / 1562°F	This ceramic based coating ensures a smooth surface and a low affinity to cold welding or edge build up, which makes it optimal for Aluminum and copper applications. It has high toughness and high hardness.
	Titanium Carbonitride (TiCN)	pink-red	Multilayer	1–4 microns	3000	0.3–0.45	400°C / 752°F	A very wear resistant coating with high toughness and shock resistance. Good in interrupted cuts found in applications like milling.
	Proprietary (TX)	black	Nano Composite	1–4 microns	3600	0.45	1150°C / 2100°F	The structural design of Ti-Namite-X is adapted to meet a diverse range of applications; everything from high- and low-alloy steels to hardened materials (up to 65 HRC core hardness). Ti-Namite-X is suitable for operations which require high cutting speeds, high temperatures at the cutting edge, and high metal removal rates.
	Crystalline Diamond (Diamond)	black	Monolayer	6–20 microns	>8000	0.15–0.2	800°C / 1470°F	This is the hardest coating available with the best abrasion resistance. It is carbon based so it is limited in application capabilities. This coating is suitable for machining highly abrasive, non-ferrous materials such as CFRP and graphite.
	Proprietary (TM)	copper	Nano Composite	1–4 microns	3600	0.45	1150°C / 2100°F	Features include high wear resistance, reduced friction, and excellent prevention of edge build up. This coating provides superior material removal rates and tool life when used in high performance operations with difficult to machine materials like Titanium.



High Performance End Mills



Milling

HIGH PERFORMANCE END MILLS	SERIES	DESCRIPTION	PAGE
Z-Carb-HPR	Z5	5 Flute Rougher Square End Fractional	28
	Z5CR	5 Flute Rougher Corner Radius Fractional	29
	Z5MCR	5 Flute Rougher Corner Radius Metric	33
Z-Carb-AP	Z1PCR	4 Flute Variable Rake Corner Radius Fractional	36
	Z1MPCR	4 Flute Variable Rake Corner Radius Metric	42
	Z1PLC	4 Flute Variable Rake Long Reach Corner Radius Fractional	38
	Z1MPIC	4 Flute Variable Rake Intermediate Reach Corner Radius Metric	43
	Z1MPLC	4 Flute Variable Rake Long Reach Corner Radius Metric	44
	Z1PLB	4 Flute Variable Rake Ball End Long Reach Fractional	39
	Z1	4 Flute Variable Geometry Square End Fractional	47
Z-Carb	Z1M	4 Flute Variable Geometry Square End Metric	52
	Z1B	4 Flute Variable Geometry Ball End Fractional	49
	Z1MB	4 Flute Variable Geometry Ball End Metric	53
	Z16CR	4 Flute Variable Geometry Corner Radius Fractional	48
	Z16CR	4 Flute Variable Geometry Corner Radius Fractional	48
Z-Carb-HTA	ZH1CR	4 Flute Variable Geometry High Temp Alloys Corner Radius Fractional	56
	ZH1MCR	4 Flute Variable Geometry High Temp Alloys Corner Radius Metric	58
	ZH1MCRS	4 Flute Variable Geometry High Temp Alloys Stub Corner Radius Metric	58
Z-Carb-MD	ZD1CR	4 Flute Variable Geometry Hard Materials Long Reach Corner Radius Fractional	60
	ZD1MCR	4 Flute Variable Geometry Hard Materials Long Reach Corner Radius Metric	61
Series 7	7	4 Flute Variable Geometry Long Length Square End Fractional	100
	7M	4 Flute Variable Geometry Long Length Square End Metric	103
	7B	4 Flute Variable Geometry Long Length Ball End Fractional	101
	7MB	4 Flute Variable Geometry Long Length Ball End Metric	104
V-Carb	55	5 Flute Finisher & Semi-Finisher Square End Fractional	63
	55CR	5 Flute Finisher & Semi-Finisher Corner Radius Fractional	64
	55B	5 Flute Finisher & Semi-Finisher Ball End Fractional	65
	55M	5 Flute Finisher & Semi-Finisher Square End Metric	68
	55MCR	5 Flute Finisher & Semi-Finisher Corner Radius Metric	69
	55MB	5 Flute Finisher & Semi-Finisher Ball End Metric	71

Speed & Feed Recommendations listed after each series

HIGH PERFORMANCE END MILLS	SERIES	DESCRIPTION	PAGE
T-Carb®	51	6 Flute High Speed Machining Square End Fractional	75
	51M	6 Flute High Speed Machining Square End Metric	80
	51L	6 Flute High Speed Machining Square End Long Reach Fractional	76
	51ML	6 Flute High Speed Machining Square End Long Reach Metric	82
	51CR	6 Flute High Speed Machining Corner Radius Fractional	75
	51MCR	6 Flute High Speed Machining Corner Radius Metric	81
	51LC	6 Flute High Speed Machining Long Reach Corner Radius Fractional	77
	51MLC	6 Flute High Speed Machining Long Reach Corner Radius Metric	83
Multi-Carb	66	Multi-Flute Finisher Square End Fractional	86
	66M	Multi-Flute Finisher Square End Metric	89
	66CR	Multi-Flute Finisher Corner Radius Fractional	86
	66MCR	Multi-Flute Finisher Corner Radius Metric	90
Turbo-Carb	56B	2 Flute Contouring Long Reach Ball End Fractional	106
	56MB	2 Flute Contouring Long Reach Ball End Metric	108
Power-Carb	57	6 Flute Finisher Square End Fractional	110
	57M	6 Flute Finisher Square End Metric	112
Series 33	33CR	3 Flute Difficult to Machine Materials Corner Radius Fractional	94
	33MCR	3 Flute Difficult to Machine Materials Corner Radius Metric	97
CFRP Slow Helix	27	4 Flute Slow Helix Square End Fractional	114
	27M	4 Flute Slow Helix Square End Metric	116

Speed & Feed Recommendations listed after each series

FRESAS DE ALTO RENDIMIENTO	SERIE	DESCRIPCIÓN	PÁGINA
Z-Carb-HPR	Z5	5 fillos, desbastador, punta cuadrada, fraccional	28
	Z5CR	5 fillos, desbastador, radio angulado, fraccional	29
	Z5MCR	5 fillos, desbastador, radio angulado, métrico	33
Z-Carb-AP	Z1PCR	4 fillos, inclinación variable, radio angulado, fraccional	36
	Z1MPCR	4 fillos, inclinación variable, radio angulado, métrico	42
	Z1PLC	4 fillos, inclinación variable, largo alcance, radio angulado, fraccional	38
	Z1MPIC	4 fillos, inclinación variable, medio alcance, radio angulado, métrico	43
	Z1MPLC	4 fillos, inclinación variable, largo alcance, radio angulado, métrico	44
	Z1PLB	4 fillos, inclinación variable, punta esférica, largo alcance, fraccional	39
Z-Carb	Z1	4 fillos, geometría variable, punta cuadrada, fraccional	47
	Z1M	4 fillos, geometría variable, punta cuadrada, métrico	52
	Z1B	4 fillos, geometría variable, punta esférica, fraccional	49
	Z1MB	4 fillos, geometría variable, punta esférica, métrico	53
	Z16CR	4 fillos, geometría variable, radio angulado, fraccional	48
Z-Carb-HTA	ZH1CR	4 fillos, geometría variable, aleaciones a altas temperaturas, radio angulado, fraccional	56
	ZH1MCR	4 fillos, geometría variable, aleaciones a altas temperaturas, radio angulado, métrico	58
	ZH1MCRS	4 fillos, geometría variable, aleaciones a altas temperaturas, versión corta, radio angulado, métrico	58
Z-Carb-MD	ZD1CR	4 fillos, geometría variable, materiales duros, largo alcance, radio angulado, fraccional	60
	ZD1MCR	4 fillos, geometría variable, materiales duros, largo alcance, radio angulado, métrico	61
Serie 7	7	4 fillos, geometría variable, longitud larga, punta cuadrada, fraccional	100
	7M	4 fillos, geometría variable, longitud larga, punta cuadrada, métrico	103
	7B	4 fillos, geometría variable, longitud larga, punta esférica, fraccional	101
	7MB	4 fillos, geometría variable, longitud larga, punta esférica, métrico	104
V-Carb	55	5 fillos, acabador y semiacabador, punta cuadrada, fraccional	63
	55CR	5 fillos, acabador y semiacabador, radio angulado, fraccional	64
	55B	5 fillos, acabador y semiacabador, punta esférica, fraccional	65
	55M	5 fillos, acabador y semiacabador, punta cuadrada, métrico	68
	55MCR	5 fillos, acabador y semiacabador, radio angulado, métrico	69
	55MB	5 fillos, acabador y semiacabador, punta esférica, métrico	71
T-Carb®	51	6 fillos, mecanizado de alta velocidad, punta cuadrada, fraccional	75
	51M	6 fillos, mecanizado de alta velocidad, punta cuadrada, métrico	80
	51L	6 fillos, mecanizado de alta velocidad, punta cuadrada, largo alcance, fraccional	76
	51ML	6 fillos, mecanizado de alta velocidad, punta cuadrada, largo alcance, métrico	82
	51CR	6 fillos mecanizado de alta velocidad, radio angulado, fraccional	75
	51MCR	6 fillos mecanizado de alta velocidad, radio angulado, métrico	81
	51LC	6 fillos mecanizado de alta velocidad, largo alcance, radio angulado, fraccional	77
	51MLC	6 fillos mecanizado de alta velocidad, largo alcance, radio angulado, métrico	83
Multi-Carb	66	Filo múltiple, acabador, punta cuadrada, fraccional	86
	66M	Filo múltiple, acabador, punta cuadrada, métrico	89
	66CR	Filo múltiple, acabador, radio angulado, fraccional	86
	66MCR	Filo múltiple, acabador, radio angulado, métrico	90
Turbo-Carb	56B	2 fillos, contorneado, largo alcance, punta esférica, fraccional	106
	56MB	2 fillos, contorneado, largo alcance, punta esférica, métrico	108
Power-Carb	57	6 fillos, acabador, punta cuadrada, fraccional	110
	57M	6 fillos, acabador, punta cuadrada, métrico	112
Serie 33	33CR	3 fillos, materiales difíciles de mecanizar, radio angulado, fraccional	94
	33MCR	3 fillos, materiales difíciles de mecanizar, radio angulado, métrico	97
Helicoidal de avance lento CFRP	27	4 fillos, helicoidal de avance lento, punta cuadrada, fraccional	114
	27M	4 fillos, helicoidal de avance lento, punta cuadrada, métrico	116

Recomendaciones de velocidades y avances mostradas tras cada serie

FRAISES A DETOURER UNIVERSELLES	SÉRIES	DESCRIPTION	PAGE
Z-Carb-HPR	Z5	5 dents à bout plat d'ébauche (fractionnel)	28
	Z5CR	5 dents rayon en coin d'ébauche (fractionnel)	29
	Z5MCR	5 dents rayon en coin d'ébauche (métrique)	33
Z-Carb-AP	Z1PCR	4 dents à vague de coupe variable rayon en coin (fractionnel)	36
	Z1MPCR	4 dents à vague de coupe variable rayon en coin (métrique)	42
	Z1PLC	4 dents à vague de coupe variable longue portée rayon en coin (fractionnel)	38
	Z1MPIC	4 dents à vague de coupe variable portée intermédiaire rayon en coin (métrique)	43
	Z1MPLC	4 dents à vague de coupe variable longue portée rayon en coin (métrique)	44
	Z1PLB	4 dents à vague de coupe variable longue portée à bout hémisphérique (fractionnel)	39
	Z-Carb	Z1	4 dents géométrie variable à bout plat (fractionnel)
Z1M		4 dents géométrie variable à bout plat (métrique)	52
Z1B		4 dents géométrie variable à bout hémisphérique (fractionnel)	49
Z1MB		4 dents géométrie variable à bout hémisphérique (métrique)	53
Z16CR		4 dents géométrie variable rayon en coin (fractionnel)	48
Z-Carb-HTA	ZH1CR	4 dents géométrie variable alliages haute température rayon en coin (fractionnel)	56
	ZH1MCR	4 dents géométrie variable alliages haute température rayon en coin (métrique)	58
	ZH1MCRS	4 dents géométrie variable, alliages haute température, longueur de l'outil court, rayon en coin (métrique)	58
Z-Carb-MD	ZD1CR	4 dents géométrie variable matériaux durs longue portée rayon en coin (fractionnel)	60
	ZD1MCR	4 dents géométrie variable matériaux durs longue portée rayon en coin (métrique)	61
Série 7	7	4 dents géométrie variable à queue longue à bout plat (fractionnel)	100
	7M	4 dents géométrie variable à queue longue à bout plat (métrique)	103
	7B	4 dents géométrie variable à queue longue à bout hémisphérique (fractionnel)	101
	7MB	4 dents géométrie variable à queue longue à bout hémisphérique (métrique)	104
V-Carb	55	5 dents en bout de finition et semi-finition plat (fractionnel)	63
	55CR	5 dents en bout finition et semi-finition rayon en coin (fractionnel)	64
	55B	5 dents en bout de finition et semi-finition hémisphérique (fractionnel)	65
	55M	5 dents en bout de finition et semi-finition plat (métrique)	68
	55MCR	5 dents en bout finition et semi-finition rayon en coin (métrique)	69
	55MB	5 dents en bout de finition et semi-finition hémisphérique (métrique)	71
T-Carb®	51	6 dents pour usinage grande vitesse à bout plat (fractionnel)	75
	51M	6 dents pour usinage grande vitesse à bout plat (métrique)	80
	51L	6 dents pour usinage grande vitesse à bout plat longue portée (fractionnel)	76
	51ML	6 dents pour usinage grande vitesse à bout plat longue portée (métrique)	82
	51CR	6 dents pour usinage grande vitesse rayon en coin (fractionnel)	75
	51MCR	6 dents pour usinage grande vitesse rayon en coin (métrique)	81
	51LC	6 dents pour usinage grande vitesse longue portée rayon en coin (fractionnel)	77
	51MLC	6 dents pour usinage grande vitesse longue portée rayon en coin (métrique)	83
Multi-Carb	66	Multi-dents en bout de finition plat (fractionnel)	86
	66M	Multi-dents en bout de finition plat (métrique)	89
	66CR	Multi-dents en bout de finition rayon en coin (fractionnel)	86
	66MCR	Multi-dents en bout de finition rayon en coin (métrique)	90
Turbo-Carb	56B	2 dents contournage longue portée à bout hémisphérique (fractionnel)	106
	56MB	2 dents contournage longue portée à bout hémisphérique (métrique)	108
Power-Carb	57	6 dents en bout de finition plat (fractionnel)	110
	57M	6 dents en bout de finition plat (métrique)	112
Série 33	33CR	3 dents usinage des matériaux difficiles rayon en coin (fractionnel)	94
	33MCR	3 dents usinage des matériaux difficiles rayon en coin (métrique)	97
CFRP hélice lente	27	4 dents hélice lente à bout plat (fractionnel)	114
	27M	4 dents hélice lente à bout plat (métrique)	116

Recommandatvions de vitesse et avance indiquées après chaque série

HOCHLEISTUNGS-SCHAFTFRÄSER	SERIE	BESCHREIBUNG	SEITE
Z-Carb-HPR	Z5	Zölliger Schruppfräser mit 5 Schneidekanten ohne Eckenradien	28
	Z5CR	Zölliger Schruppfräser mit 5 Schneidekanten und Eckenradien	29
	Z5MCR	Metrischer Schruppfräser mit 5 Schneidekanten und Eckenradien	33
Z-Carb-AP	Z1PCR	Zölliger Fräser mit 4 variablen Schneidekanten und Eckenradien	36
	Z1MPCR	Metrischer Fräser mit 4 Schneidekanten und variablen Spanwinkel	42
	Z1PLC	Zölliger Tiefbohr-fräser mit 4 variablen Schneidekanten und Eckenradien	38
	Z1MPIC	Metrischer Fräser mittlerer Länge mit 4 variablen Schneidekanten und Eckenradien	43
	Z1MPLC	Metrischer Tiefbohr-fräser mit 4 variablen Schneidekanten und Eckenradien	44
	Z1PLB	Zölliger Radiuschaftfräser mit 4 Schneidekanten und variablem Spanwinkel	39
Z-Carb	Z1	Zölliger Schaftfräser mit 4 Schneidekanten ohne Eckenradien und variabler Form	47
	Z1M	Metrischer Schaftfräser mit 4 Schneidekanten ohne Eckenradien und variabler Form	52
	Z1B	Zölliger Radiuschaftfräser mit 4 Schneidekanten und variabler Form	49
	Z1MB	Metrischer Radiuschaftfräser mit 4 Schneidekanten und variabler Form	53
	Z16CR	Zölliger Fräser mit 4 variablen Schneidekanten und Eckenradien	48
Z-Carb-HTA	ZH1CR	Hochwarmfester zölliger Fräser mit 4 variablen Schneidekanten und Eckenradien	56
	ZH1MCR	Hochwarmfester metrischer Fräser mit 4 variablen Schneidekanten und Eckenradien	58
	ZH1MCRS	Hochwarmfester metrischer Fräser mit 4 variablen Schneidekanten und Eckenradien	58
Z-Carb-MD	ZD1CR	Zölliger Tiefbohr-fräser mit 4 variablen Schneidekanten, Eckenradien und Form aus Hartmetall	60
	ZD1MCR	Metrischer Tiefbohr-fräser mit 4 variablen Schneidekanten, Eckenradien und Form aus Hartmetall	61
Serie 7	7	Zölliger Langloch-Schaftfräser mit 4 Schneidekanten ohne Eckenradien und variabler Form	100
	7M	Metrischer Langloch-Schaftfräser mit 4 Schneidekanten ohne Eckenradien und variabler Form	103
	7B	Zölliger Langloch-Radiuschaftfräser mit 4 Schneidekanten und variabler Form	101
	7MB	Metrischer Langloch-Radiuschaftfräser mit 4 Schneidekanten und variabler Form	104
V-Carb	55	Zölliger Schlicht- und Halbschlichtfräser mit 5 Schneidekanten ohne Eckenradien und variabler Form	63
	55CR	Zölliger Schlicht- und Halbschlichtfräser mit 5 Schneidekanten ohne Eckenradien	64
	55B	Metrischer Schlicht- und Halbschlicht-Radiuschaftfräser mit 5 Schneidekanten ohne Eckenradien	65
	55M	Metrischer Schlicht- und Halbschlichtfräser mit 5 Schneidekanten ohne Eckenradien und variabler Form	68
	55MCR	Metrischer Schlicht- und Halbschlichtfräser mit 5 Schneidekanten und Eckenradien	69
	55MB	Metrischer Schlicht- und Halbschlicht-Radiuschaftfräser mit 5 Schneidekanten und variabler Form	71
T-Carb®	51	Zölliger Schaftfräser aus Schnellstahl mit 6 Schneidekanten ohne Eckenradien	75
	51M	Metrischer Schaftfräser aus Schnellstahl mit 6 Schneidekanten ohne Eckenradien	80
	51L	Zölliger Langloch-Schaftfräser aus Schnellstahl mit 6 Schneidekanten ohne Eckenradien	76
	51ML	Metrischer Langloch-Schaftfräser aus Schnellstahl mit 6 Schneidekanten ohne Eckenradien	82
	51CR	Zölliger Fräser aus Schnellstahl mit 6 Schneidekanten und Eckenradien	75
	51MCR	Metrischer Fräser aus Schnellstahl mit 6 Schneidekanten und Eckenradien aus Schnellstahl	81
	51LC	Zölliger Tiefbohr-fräser aus Schnellstahl mit 6 Schneidekanten und Eckenradien	77
	51MLC	Metrischer Tiefbohr-fräser aus Schnellstahl mit 6 Schneidekanten und Eckenradien	83
Multi-Carb	66	Zölliger mehrschneidiger Schlichtfräser ohne Eckenradien	86
	66M	Metrischer mehrschneidiger Schlichtfräser ohne Eckenradien	89
	66CR	Zölliger mehrschneidiger Schlichtfräser mit Eckenradien	86
	66MCR	Metrischer mehrschneidiger Schlichtfräser mit Eckenradien	90
Turbo-Carb	56B	Zölliger Langloch-Profil-Radiuschaftfräser mit 2 Schneidekanten	106
	56MB	Metrischer Langloch-Profil-Radiuschaftfräser mit 2 Schneidekanten	108
Power-Carb	57	Zölliger Schlichtfräser mit 6 Schneidekanten ohne Eckenradien	110
	57M	Metrischer Schlichtfräser mit 6 Schneidekanten ohne Eckenradien	112
Serie 33	33CR	Zölliger Fräser aus Schnellstahl mit 3 Schneidekanten und Eckenradien für schwerspanbare Werkstoffe	94
	33MCR	Metrischer Fräser aus Schnellstahl mit 3 Schneidekanten und Eckenradien für schwerspanbare Werkstoffe	97
CFRP Slow Helix	27	Zölliger Schaftfräser mit 4 steilen Schneidekanten ohne Eckenradien	114
	27M	Metrischer Schaftfräser mit 4 steilen Schneidekanten ohne Eckenradien	116

Empfehlungen für Drehzahl & Vorschub im Anhang zu jeder Serie

End Mill Matrix

Name	Series	Page No.	Material							No. Flutes	Helix °	Flute Index	Rake	Relief	Center Cutting	
			Steel	Stainless Steels	Cast Iron	High Temp Alloys	Titanium Alloys	Non Ferrous	Plastics, Composites							Hardened Steels
Z-Carb HPR	Z5	28	★	★	★	★	★			☆	5	37	≠	+	E	N
Z-Carb	Z1 / Z16 / Z1B	47	★	★	★	★	★			☆	4	35 / 38	≠	+	E	Y
Z-Carb-AP	Z1P	36	★	★	★	★	★			☆	4	35 / 38	≠	+	E	Y
Z-Carb-HTA	ZH1	56	★	★	★	★	★			☆	4	38 / 41	≠	+	E	Y
Z-Carb-MD	ZD1	60	★	★	★	★	★			★	4	42 / 45	≠	-	E	Y
Series 33	33	94	★	★	★	★	★			☆	3	32 / 48	≠	+	E	Y
T-Carb®	51	75	★	★	★	★	★			☆	6	41	≠	+	E	Y
Series 7	7	100	★	★	★	★	★			☆	4	38	≠	+	P-S	Y
V-Carb	55	63	★	★	★	★	★			☆	5	45	≠	+	P-S	Y
Multi-Carb	66	86	★	★	★	★	★			☆	7, 9, 11	35	=	+	E	N
Turbo-Carb	56B	106	★	★	★	★	★			★	2	30	=	+	E	Y
Power-Carb	57	110	★	★	★	★	★			★	6	45	=	-	E	Y
Ski-Carb	44, 45	164	★	★	★	★	★		★	★	2	45	=	+	P-S	Y
S-Carb® 3 Flute	43	134	★	★	★	★	★		★	★	3	38	=	+	E	Y
S-Carb® Chipbreaker	43CB	144	★	★	★	★	★		★	★	3	38	=	+	E	Y
S-Carb® 2 Flute	47	157	★	★	★	★	★		★	★	2	35	=	+	E	Y
S-Carb APR®	43APR	123	★	★	★	★	★		★	★	3	38	=	+	E	Y
S-Carb APR-3®	APR3	129	★	★	★	★	★		★	★	3	38	≠	+	E	Y
S-Carb APR-4®	APR4	130	★	★	★	★	★		★	★	4	38 / 41	≠	+	E	Y
S-Carb APF®	43APF	125	★	★	★	★	★		★	★	4	38 / 41	≠	+	E	Y
Slow Helix	27	114	★	★	★	★	★		★	★	4	10 / 12	≠	+	P-S	Y
CCR *	20-CCR	356	★	★	★	★	★		★	★	8, 10, 12	15	=	+	C	EM or DR
CCR *	31-CCR	362	★	★	★	★	★		★	★	5, 7, 10	15	=	+	C	EM or DR
PCR *	29-PCR	352	★	★	★	★	★		★	★	8, 9, 12	15	=	0	E	EM or DR
Compression Router	25	366	★	★	★	★	★		★	★	4, 6, 8	30	=	+	P-S	Y
Up Cut Router	21	370	★	★	★	★	★		★	★	2	35	=	+	P-S	Y
Down Cut Router	22	371	★	★	★	★	★		★	★	2	35	=	+	P-S	Y

Main Key

- ★ Primary Function
- ☆ Secondary Function
- 🔵 Coolant Required
- 🚫 Plunging NOT Recommended

Coating Key

- Ti-Namite-A (TA) = AlTiN
- Ti-Namite-X (TX) = Proprietary nanocomposite
- Ti-Namite-M (TM) = AlTiSiN nanocomposite
- Ti-Namite-B (TB) = TiB2
- Di-Namite® = polycrystalline diamond

Rake Key

- + = Positive
- = Negative
- 0 = Neutral

Center Cutting Key

- Y = Yes
- N = No
- EM = End Mill End
- DR = Drill End

Relief Key

- E = Eccentric
- P-S = Primary - Secondary
- C = Concave

End Mill Matrix

Coating	Ae % Ap %	Finishing					HSM				Profiling						Slotting						Ramping			Plunging										
		2	2	5	5	5	5	5	10	10	25	50	25	50	25	50	100	100	100	100	100	100	1°	3°	6°	Ap 50%	Ap 100%									
		100	200	100	200	300	100	200	100	200	100	100	150	150	200	200	25	50	75	100	150	200														
TM / TA		☆	☆	☆	☆		★	★	★	★	★	★	★	★	★	★	★	★	★	★	★	★	★	★	★	★	★	★	★	★	★	★	★			
TA / TX		☆	☆	☆	☆		☆	☆	☆	☆	★	★	★	★	★	☆	★	★	★	★	☆		★	★	☆		★	★	☆							
TX		☆	☆	☆	☆		☆	☆	☆	☆	★	★	★	★	★	☆	★	★	★	★	★	★	★	★	★	★	★	★	★	★	★	★	★	★	★	
TA		☆	☆	☆	☆		☆	☆	☆	☆	★	★	★	★	★	☆	★	★	★	★	☆		★	★	☆		★	★	☆							
TX		☆	☆	☆	☆		☆	☆	☆	☆	★	★	★	★	★	☆	★	★	★	★			★	★	☆		★	★	☆							
TA		☆	☆	☆	☆		☆	☆	☆	☆	★	★	★	★	★	☆	★	★	★	★	★	★	★	★	★	★	★	★	★	★	★	★	★	★	★	
TX		☆	☆	☆	☆		★	★	★	★	☆		☆														★	☆								
TX		★	★	★	★	★																					★									
TA		★	★	★	★		☆	☆			☆		☆							☆	☆						★	☆								
TX		★	★	★	★																						★									
TX		★	★	★	★		★	★	☆		☆	☆							☆							★	☆									
TX		★	★	★	★		★	★	★		★	☆	☆					★	☆							★										
TB		★	★	★	★		★	★	★	☆	★	★	★	★	☆		★	★	★	★	☆	☆	★	★	★	★	★	★	★	★	★	★	★	★	★	
TB		★	★	★	★		★	★	★	☆	★	★	★	★	☆		★	★	★	★	☆	☆	★	★	★	★	★	★	★	★	★	★	★	★	★	
TB							★	★	★	★	★	★	★	★	☆	☆	★	★	★	★	★	★	★	★	★	★	★	★	★	★	★	★	★	★	★	★
TB		☆	☆	☆	☆		☆	☆	☆	☆	★	★	★	★	☆		★	★	★	★	☆	☆	★	★	★	★	★	★	★	★	★	★	★	★	★	
TB							★	★	★	★	★	★	★	★	☆	☆	★	★	★	★	★	★	★	★	★	★	★	★	★	★	★	★	★	★	★	★
TB							★	★	★	★	★	★	★	★	☆	☆	★	★	★	★	★	★	★	★	★	★	★	★	★	★	★	★	★	★	★	★
TB							★	★	★	★	★	★	★	★	☆	☆	★	★	★	★	★	★	★	★	★	★	★	★	★	★	★	★	★	★	★	★
TB		★	★	★	★	★	★	★	★	☆																	★	★	☆							
Di-Namite® (opt.)		☆	☆	☆	☆	☆					★	★	★	★	★	☆	★	★	★	★	☆	☆	★	★	★	★	★	★	★	★	★	★	★	★	★	
Di-Namite® (opt.)		☆	☆	☆	☆	☆					★	★	★	★	★	☆	★	★	★	★	☆	☆	★	★	★	★	★	★	★	★	★	★	★	★	★	
Di-Namite® (opt.)		☆	☆	☆	☆	☆					★	★	★	★	★	★	★	★	★	★	★	★	★	★	★	★	★	★	★	★	★	★	★	★	★	★
Di-Namite® (opt.)		☆	☆	☆	☆	☆					★	★	★	★	★	☆	★	★	★	★	☆	☆	★	★	★	★	★	★	★	★	★	★	★	★	★	★
Di-Namite® (opt.)		★	★	★	★	★					☆	☆	☆	☆	☆	☆												★								
various (opt.)		☆	☆	☆	☆	☆					★	★	★	★	★	★	★	★	★	★	★	★	★	★	★	★	★	★	★	★	★	★	★	★	★	★
various (opt.)		☆	☆	☆	☆	☆					★	★	★	★	★	★	★	★	★	★	★	★	★	★	★	★	★	★	★	★	★	★	★	★	★	★

Ramping Basics
 Use 100% of slotting feed rates for 1° ramp
 Use 50% of slotting feed rates for 3° ramp
 Use 25% of slotting feed rates for 6° ramp

Plunging Basics
 Use 50% of slotting feed rates in Non-Ferrous materials
 Use 20% of slotting feed rates for all other plungable materials

Notes
 Reduce speed, feed, and cut depths as material hardness increases—see KYOCERA SGS Tool Wizard® for recommendations
 Long flute or long reach tools also require reduced rates and cut depths
 Machine, tool holding, work holding, and coolant also affect rates and cut depths

***For Ramping and Plunging:**
 Non-end cut version not intended for ramping or plunging
 End cut version intended for ramping only
 Drill end intended for plunging only

Application Tips

Tool	<ul style="list-style-type: none"> • Whenever possible, select an end mill with the largest diameter, shortest flute length, and shortest overall length for the best rigidity • Long flute tools are not intended for pocketing, slotting, or heavy profiling – limit Ae to .02D • High Performance tools minimize cycle time and extend tool life
Tool Holders	<ul style="list-style-type: none"> • Holders with adequate gripping pressure and TIR are required • Stub holders or zero length collet style holders are recommended for heavy stock removal • When using solid holders, hand ground screw flats are not recommended
Workpiece	<ul style="list-style-type: none"> • Secure clamping of the workpiece will reduce chatter and deflection
Machine	<ul style="list-style-type: none"> • Spindle must be in optimum condition for precise TIR and maximum tool life • Sufficient horsepower is required to perform at recommended speeds and feeds • Reduce rates for low power machines to prevent workpiece and / or tool damage
Coolant	<ul style="list-style-type: none"> • Avoid re-milling chips through use of air blast or liquid coolant as necessary • Maintain clean coolant with appropriate concentration • General recommendations: <ul style="list-style-type: none"> —Water Soluble Oil or Air Blast: Tool Steels, Mold & Die Steels, Carbon or Alloy Steels —Water Soluble Oil: Stainless Steels, Titanium, High Temperature Alloys, Non-Ferrous Alloys
Methods	<ul style="list-style-type: none"> • Climb milling is generally preferred • Attention to programming details, tool holders, TIR, balance, fixturing, etc. improve cutting tool performance and extend tool life

END MILLING GUIDELINE

D_1 = cutting diameter L_2 = flute length

Speeds and Feeds for Cut Types are based on Radial Width (A_e) and Axial Depth (A_p)

Reductions to Speeds and Feeds may be necessary when:

- A_e and A_p exceed recommendations
- Using long flute or extended reach tools
- Using long tool holders
- Machining materials harder than listed

ENTRY METHODS

Pre-Drilled Hole



Pre-drilling is the preferred entry method for most applications.

Helical Ramp



Straight Ramp

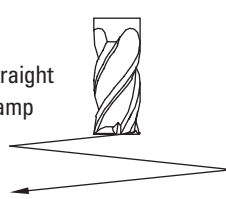

Alternative methods are helical and straight ramping. High ramp angles require reduced feed. Lower ramp angles will allow higher feed rates and extend tool life. Use slotting speeds and feeds for ramp angles of 1° to 2°. Reduce feed to 25% when ramp angles approach 6°. General purpose tools and/or difficult to machine materials will require lower ramp angles and reduced feed.

Plunge



Plunge only in non-ferrous and short-chipping materials using slotting speeds and 25% slotting feeds.

Herramientas	<ul style="list-style-type: none"> • Siempre que sea posible, seleccione el cortador con el mayor diámetro, largo de filo y largo total mas corto posible para obtener una mejor rigidez. • Las herramientas con filos largos no son recomendadas para operaciones de apertura de cajas en el maquinado, operación de ranurado o perfilado pesado – limitar la profundidad radial (Ae) a .02D • Las herramientas de alto desempeño minimizan el tiempo de ciclo del maquinado y extienden la vida útil de la herramienta
Portaherramientas	<ul style="list-style-type: none"> • Los Portaherramientas deberán tener buena presión de agarre para la sujeción de la herramienta y una concetricidad máxima indicada (TIR) • Se recomienda usar portaherramientas de agarre directo cortos, o de boquilla con longitud cero para lograr un máximo arranque de viruta • Cuando se utilicen portaherramientas de agarre directo, no se recomienda hacer manualmente el plano para la sujeción del tornillo en el zanco de la herramienta
Pieza a maquinar	<ul style="list-style-type: none"> • La buena sujeción de la pieza a maquinar reducirá la vibración y la desviación de la herramienta
Máquina	<ul style="list-style-type: none"> • El usillo de la maquina debe estar en condiciones optimas, para asegurar la concetricidad de giro (TIR) y asegurar el máximo rendimiento de la herramienta • Para lograr los avances y velocidades recomendados, se necesita suficiente potencia (HP) en la maquina • Reducir los parámetros de corte en maquinas de baja potencia (HP) para prevenir el daño en la herramienta o pieza de trabajo
Refrigerante	<ul style="list-style-type: none"> • Evite el re-maquinado de virutas usando aire a presión o líquido refrigerante según sea necesario • Mantener limpio el refrigerante con su concentración adecuada • Recomendaciones generales: <ul style="list-style-type: none"> –Para el maquinado de Aceros Grado Herramienta, para Moldes y Dados o Aleaciones de Bajo Carbón, utilice Aceite Soluble en Agua o aire a presión –Para el maquinado de Aleaciones Inoxidables, Aleaciones de Alta Temperatura, Titanio y Aleaciones No Ferrosas, utilice solamente Aceite Soluble en Agua
Métodos	<ul style="list-style-type: none"> • Se recomienda el maquinado en sentido ascendente o trepado • El cuidado en los detalles de la programación, la concetricidad de giro (TIR) el balance de los portaherramientas, la sujeción de la pieza a maquinar, etc. son factores que contribuyen a prolongar la vida de la herramienta

GUÍAS DE FRESADO

D_1 = diámetro de corte L_2 = largo de filo

Las velocidades y avances para cortes están basados en la profundidad radial (A_e), y profundidad axial (A_p)

Reducciones en velocidades y avances serán necesarias cuando:

- A_e y A_p exceda las recomendaciones
- Se utilicen filos largos o herramientas de largo alcance
- Se utilicen portaherramientas largos
- Se maquinen materiales más duros que los recomendados

MÉTODOS DE ENTRADA

Barreno previo



Preferentemente usar un barreno previo como método de entrada para la mayor parte de las aplicaciones.

Rampa helicoidal



Rampa recta

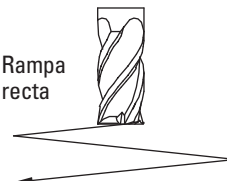

Los métodos alternativos son las rampas helicoidales y rectas. Un ángulo elevado de rampa necesita un avance reducido. Un ángulo de rampa inferior permitirá tasas de avance más elevadas y una mayor duración de la herramienta. Usar velocidades y alcances de ranurado para ángulos de rampa de 1° a 2° . Disminuir el avance un 25% cuando los ángulos de rampa se aproximan a 6° . Las herramientas de uso general y/o materiales difíciles de mecanizar precisarán ángulos de rampa inferiores y un avance reducido.

Agujero o Barrenado



Este método se puede utilizar únicamente en materiales no ferrosos y materiales de formación de virutas cortas, usando la velocidad de ranurado y el 25% de su avance.

Conseils relatifs à l'application

Outil	<ul style="list-style-type: none"> • Chaque fois que possible, choisissez une fraise de plus grand diamètre possible, la plus courte possible, elle garantira la meilleure rigidité • Les outils longs ne sont pas optimum pour l'ébauche, le pocketing, le rainurage – Ae limité à 0,02 D • Les outils Haute performance optimisent les temps de cycle et de augmentent la durée de vie
Porte-outils	<ul style="list-style-type: none"> • Des attachements à serrage puissant et à faux rond précis sont recommandés • Attachements à méplats ou pinces à serrage nominale sont recommandées pour les ébauches • Lorsque vous utilisez des attachement rigides, les serrage de l'outil par vis ne sont pas recommandés
Pièce	<ul style="list-style-type: none"> • Le système de fixation et de bridage de la pièce devra permettre de réduire les vibrations et la déformation
Machine	<ul style="list-style-type: none"> • Broche doit être en bon état optimal au niveau de son faux rond • Suffisamment puissance est nécessaire pour effectuer à des vitesses recommandées et se nourrit • Réduire les efforts pour les machines de faible puissance pour éviter l'endommagement de la pièce et / ou de l'outil
Liquide de refroidissement	<ul style="list-style-type: none"> • Évitez les recyclage de copeaux par l'utilisation de soufflage d'air comprimé ou de liquide de refroidissement. • Maintenir le lubrifiant propre à la concentration appropriée • Recommandations générales – <ul style="list-style-type: none"> –Huile soluble ou Air comprimé: aciers à outils, aciers pour moules, aciers au carbone ou alliés –Huile soluble: aciers inoxydables, titane, alliages à haute température, alliages non ferreux
Méthodes	<ul style="list-style-type: none"> • L'usinage en avalant est généralement préconisé • Attention à la programmation, porte-outils, faux rond, équilibrage, fixation, etc améliorent les performances de l'outil en coupe et prolonge la durée de vie

GUIDE DU FRAISAGE

D_1 = diamètre de coupe L_2 = longueur de coupe

Vitesses & avances pour ces cas d'usinage sont basées sur l'engagement radial (A_e), et axial (A_p)

La réduction de la vitesse et de l'avance doit être nécessaire quand:

- Les engagements A_e et A_p sont importants
- Des dentures longues ou des séries longues sont utilisées
- Des attachement longs sont utilisés
- Lors d'usinage de matériaux durs

TYPES D'ENTREE MATIERE

Preperçage



Le préperçage est la méthode préférable dans la plupart de applications.

Ramping hélicoïdal



Ramping droit

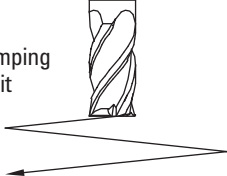

Les autres méthodes sont un ramping hélicoïdal et un ramping droit. Les angles de ramping élevés exigent une avance inférieure. Les angles de ramping inférieurs permettent les taux d'avance supérieurs et prolongeront la vie de l'outil. Utilisez des avances et vitesses de mortaisage pour les angles de ramping de 1° à 2°. Réduisez l'avance à 25 % lorsque les angles de ramping avoisinent 6°. Les outils tout usage et/ou les matériaux difficiles à usiner exigeront des angles de ramping inférieurs et une charge réduite.

Plongée



Plongée uniquement dans les non ferreux. Vitesse rainurage et avances réduites de 25%.

Werkzeug	<ul style="list-style-type: none"> • Wählen Sie möglichst immer den Schafffräser mit dem größten Durchmesser, der kürzesten Schneidekante und Gesamtlänge, um eine hohe Steifigkeit zu erhalten • Langlochschaftfräser sind nicht zum Taschen-, Schlitz- oder Profilfräsen bestimmt – die Dehnung auf A_e 0,2 der Streckgrenze begrenzen • Hochleistungswerkzeuge minimieren die Zykluszeit und verlängern die Werkzeugstandzeit
Werkzeughalter	<ul style="list-style-type: none"> • Es werden Spannzangen mit ausreichendem Krachtschluss und TIR benötigt • Steilkegel oder bündige Spannfutter werden bei hohem Materialabtrag empfohlen • Von der Verwendung fester handverschraubter Halterungen wird abgeraten
Werkstück	<ul style="list-style-type: none"> • Sicheres Werkzeugspannen verringert Vibrationen und das Auswandern aus der Ziellinie
Werkzeugmaschine	<ul style="list-style-type: none"> • Die Spindel muss für in optimalem Zustand sein, um genaue TIR und maximale Standzeit zu erzielen • Für die empfohlenen Drehzahlen und Vorschubgeschwindigkeiten ist genügend Leistung bereitzustellen • Bei leistungsschwachen Antrieben sind die Werte zu verringern, um Beschädigungen am Werkstück und/oder Werkzeug zu vermeiden
Kühlmittel	<ul style="list-style-type: none"> • Das Überfräsen der Späne durch Luftstrahl oder flüssige Kühlmittel möglichst verhindern • Kühlmittel in geeigneter Konzentration vorhalten • Allgemeine Empfehlungen: <ul style="list-style-type: none"> – Wasser-Öl-Emulsionen oder Luftstrahl: Werkzeugstähle, Form- und Schneidstähle, unlegierte oder legierte Stähle – Wasser-Öl-Emulsion: Nichtrostender Stahl, Titan, Warmfeste Legierungen, Nichteisenlegierungen
Verfahren	<ul style="list-style-type: none"> • Vorzugsweise Gleichlaufräsen anwenden • Das Beachten der Fräsparameter, Werkzeughalter, TIR, Auswuchten, Einspannen, usw. verbessert die Schnittleistung und verlängert die Standzeit

RICHTWERTE ZUM FRÄSEN

D_1 = Fräsdurchmesser L_2 = Schnittlänge

Drehzahl und Vorschub für Fräsarbeiten hängen von Radialbreite (A_e) und Frästiefe (A_p) ab

Drehzahl und Vorschub müssen ggfs. verringert werden wenn:

- die empfohlenen Werte für A_e und A_p überschritten werden
- lange Schneidekantenn oder Langschaftfräser verwendet werden
- lange Werkzeughalter verwendet werden
- die Werkstoffe härter als vorgesehen sind

VORBEREITUNGEN

Vorbohrung



Vorbohren ist in den meisten Fällen ratsam.

Zirkulareintauchfräsen



Schrägeintauchfräsen

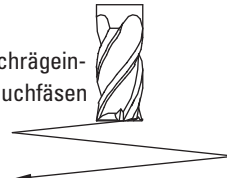

Alternative Verfahren sind Zirkulareintauchen und Schrägeintauchen. Starke Tauchwinkel erfordern verringerte Vorschubgeschwindigkeiten. Geringe Tauchwinkel ermöglichen höhere Vorschubgeschwindigkeiten und verlängern die Standzeit. Verwenden Sie die Drehzahlen und Vorschübe zum Schlitzfräsen für Tauchwinkel von 1° bis 2° . Den Vorschub auf 25 % verringern, wenn der Tauchwinkel 6° erreicht. Allzweckwerkzeuge und / oder schwer zu bearbeitende Werkstoffe verlangen kleine Tauchwinkel und verringerte Vorschubgeschwindigkeiten.

Stechen



Stechen Sie in Nichteisenmetalle und kurzspanende Werkstoffe nur mit Schlitzfräsdrehzahl und 25 % der Schlitzvorschubgeschwindigkeit ein.

FRACTIONAL Z-Carb-HPR

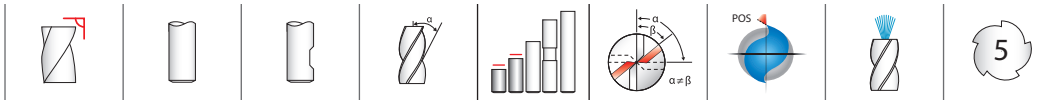

Z5 FRACTIONAL SERIES

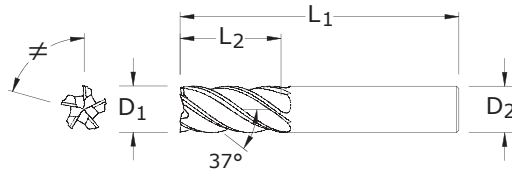

- An ideal balance of helix, indexing, flute depth, rake and relief
- Variable indexing for chatter suppression and proprietary edge geometry for shearing and strength
- Chatter-free geometry allows deep cutting and high speed machining
- Central coolant hole delivers coolant effectively to the cutting zone enhancing chip removal when pocketing or slotting
- Excels at roughing, ramping, high speed machining and finishing in a variety of materials
- Recommended for materials ≤ 45 HRc (≤ 420 Bhn)

inch				EDP NO.					
CUTTING DIAMETER D ₁	LENGTH OF CUT L ₂	OVERALL LENGTH L ₁	SHANK DIAMETER D ₂	TI-NAMITE-A (TA)	TI-NAMITE-A (TA) W/FLAT	TI-NAMITE-A (TA) W/INTERNAL COOLANT	TI-NAMITE-M (TM)	TI-NAMITE-M (TM) W/FLAT	TI-NAMITE-M (TM) W/INTERNAL COOLANT
1/8	1/4	1-1/2	1/8	-	-	-	37000	-	-
1/8	3/8	1-1/2	1/8	37180	-	-	37002	-	-
3/16	5/16	2	3/16	-	-	-	37004	-	-
3/16	1/2	2	3/16	37182	-	-	37006	-	-
1/4	3/8	2-1/2	1/4	38502	-	-	37008	-	-
1/4	1/2	2-1/2	1/4	37184	-	-	37011	-	-
5/16	7/16	2-1/2	5/16	-	-	-	37014	-	-
5/16	5/8	2-1/2	5/16	38504	-	-	37016	-	-
3/8	1/2	2-1/2	3/8	-	-	-	37018	-	-
3/8	3/4	2-1/2	3/8	37187	-	-	37021	-	-
7/16	5/8	2-1/2	7/16	37168	-	-	37159	-	-
7/16	7/8	2-3/4	7/16	37170	-	-	37169	-	-
1/2	5/8	3	1/2	38506	38512	37320	37024	37030	37321
1/2	1	3	1/2	38507	38513	37322	37036	37042	37323
1/2	1-1/4	3-1/4	1/2	37190	37194	37324	37048	37054	37325
5/8	3/4	3-1/2	5/8	38508	38514	-	37060	37067	37260
5/8	1-1/4	3-1/2	5/8	37198	37202	-	37074	37081	37267
3/4	7/8	4	3/4	-	38515	-	37088	37095	37274
3/4	1-1/2	4	3/4	37206	37210	-	37102	37109	37281
1	1-1/8	4	1	-	-	-	37116	37123	37288
1	1-1/2	4	1	37214	37218	-	37130	37137	37295
1	2	4-1/2	1	-	38517	-	37144	37151	37302

TOLERANCES (inch)

1/8-1/4 DIAMETER

D₁ = +0.0000/-0.0012

D₂ = h₆

>1/4-3/8 DIAMETER

D₁ = +0.0000/-0.0016

D₂ = h₆

>3/8-1 DIAMETER

D₁ = +0.0000/-0.0020

D₂ = h₆

- STEELS
- STAINLESS STEELS
- CAST IRON
- HIGH TEMP ALLOYS
- TITANIUM
- HARDENED STEELS

For patent information visit www.ksptpatents.com

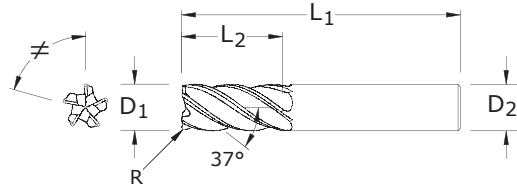
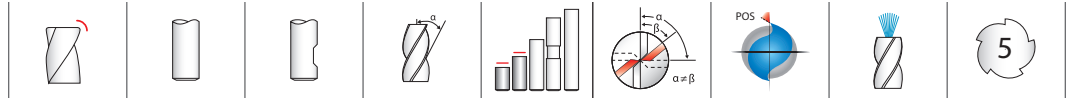

TOLERANCES (inch)

1/8–1/4 DIAMETER

$D_1 = +0.0000/-0.0012$

$D_2 = h_6$

$R = +0.0000/-0.0020$

>1/4–3/8 DIAMETER

$D_1 = +0.0000/-0.0016$

$D_2 = h_6$

$R = +0.0000/-0.0020$

>3/8–1 DIAMETER

$D_1 = +0.0000/-0.0020$

$D_2 = h_6$

$R = +0.0000/-0.0020$

STEELS

STAINLESS STEELS

CAST IRON

HIGH TEMP ALLOYS

TITANIUM

HARDENED STEELS

For patent information visit www.ksptpatents.com

inch						EDP NO.				
CUTTING DIAMETER D_1	LENGTH OF CUT L_2	OVERALL LENGTH L_1	SHANK DIAMETER D_2	CORNER RADIUS R	TI-NAMITE-A (TA)	TI-NAMITE-A (TA) W/FLAT	TI-NAMITE-A (TA) W/INTERNAL COOLANT	TI-NAMITE-M (TM)	TI-NAMITE-M (TM) W/FLAT	TI-NAMITE-M (TM) W/INTERNAL COOLANT
1/8	1/4	1-1/2	1/8	.015	38525	—	—	37001	—	—
1/8	3/8	1-1/2	1/8	.015	37181	—	—	37003	—	—
3/16	5/16	2	3/16	.015	—	—	—	37005	—	—
3/16	1/2	2	3/16	.015	37183	—	—	37007	—	—
1/4	3/8	2-1/2	1/4	.015	—	—	—	37009	—	—
1/4	3/8	2-1/2	1/4	.030	38528	—	—	37010	—	—
1/4	1/2	2-1/2	1/4	.015	37185	—	—	37012	—	—
1/4	1/2	2-1/2	1/4	.030	37186	—	—	37013	—	—
5/16	7/16	2-1/2	5/16	.015	38529	—	—	37015	—	—
5/16	5/8	2-1/2	5/16	.015	38530	—	—	37017	—	—
3/8	1/2	2-1/2	3/8	.015	—	—	—	37019	—	—
3/8	1/2	2-1/2	3/8	.030	38532	—	—	37020	—	—
3/8	3/4	2-1/2	3/8	.015	37188	—	—	37022	—	—
3/8	3/4	2-1/2	3/8	.030	37189	—	—	37023	37175	—
7/16	5/8	2-1/2	7/16	.015	37164	—	—	37160	—	—
7/16	5/8	2-1/2	7/16	.030	37165	—	—	37161	—	—
7/16	7/8	2-3/4	7/16	.015	37166	—	—	37162	—	—
7/16	7/8	2-3/4	7/16	.030	37167	—	—	37163	—	—
1/2	5/8	3	1/2	.015	—	38578	37330	37025	37031	37331
1/2	5/8	3	1/2	.030	—	38579	37332	37026	37032	37333
1/2	5/8	3	1/2	.060	—	38580	37334	37027	37033	37335
1/2	5/8	3	1/2	.090	—	38581	37337	37028	37034	37338
1/2	5/8	3	1/2	.120	—	—	37339	37029	37035	37340
1/2	1	3	1/2	.015	—	38583	37341	37037	37043	37342
1/2	1	3	1/2	.030	38539	38584	37343	37038	37044	37344
1/2	1	3	1/2	.060	—	38585	37345	37039	37045	37346
1/2	1	3	1/2	.090	—	—	37348	37040	37046	37349
1/2	1	3	1/2	.120	—	—	37350	37041	37047	37351
1/2	1-1/4	3-1/4	1/2	.015	37191	37195	37352	37049	37055	37353
1/2	1-1/4	3-1/4	1/2	.030	37192	37196	37354	37050	37056	37355
1/2	1-1/4	3-1/4	1/2	.060	37193	37197	37356	37051	37057	37357
1/2	1-1/4	3-1/4	1/2	.090	—	—	37359	37052	37058	37360
1/2	1-1/4	3-1/4	1/2	.120	—	—	37361	37053	37059	37362
5/8	3/4	3-1/2	5/8	.015	—	—	—	37061	37068	37261
5/8	3/4	3-1/2	5/8	.030	—	38591	—	37062	37069	37262
5/8	3/4	3-1/2	5/8	.060	—	—	—	37063	37070	37263
5/8	3/4	3-1/2	5/8	.090	—	—	—	37064	37071	37264
5/8	3/4	3-1/2	5/8	.120	38549	—	—	37065	37072	37265

continued on next page

Z5CR FRACTIONAL SERIES

- An ideal balance of helix, indexing, flute depth, rake and relief
- Variable indexing for chatter suppression and proprietary edge geometry for shearing and strength
- Chatter-free geometry allows deep cutting and high speed machining
- Central coolant hole delivers coolant effectively to the cutting zone enhancing chip removal when pocketing or slotting
- Enhanced corner geometry with tight tolerance corner radii
- Excels at roughing, ramping, high speed machining and finishing in a variety of materials
- Recommended for materials ≤ 45 HRC (≤ 420 Bhn)

FRACTIONAL Z-Carb-HPR

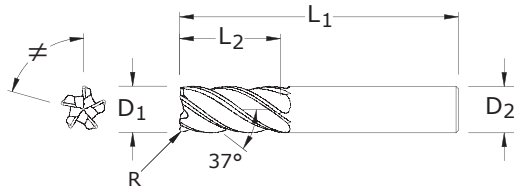
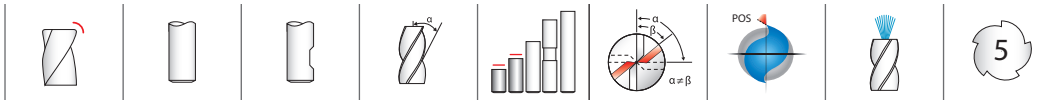

Z5CR FRACTIONAL SERIES

CONTINUED

inch					EDP NO.					
CUTTING DIAMETER	LENGTH OF CUT	OVERALL LENGTH	SHANK DIAMETER	CORNER RADIUS	TI-NAMITE-A (TA)	TI-NAMITE-A (TA) W/FLAT	TI-NAMITE-A (TA) W/INTERNAL COOLANT	TI-NAMITE-M (TM)	TI-NAMITE-M (TM) W/FLAT	TI-NAMITE-M (TM) W/INTERNAL COOLANT
5/8	3/4	3-1/2	5/8	.190	—	—	—	37066	37073	37266
5/8	1-1/4	3-1/2	5/8	.015	37199	37203	—	37075	37082	37268
5/8	1-1/4	3-1/2	5/8	.030	37200	37204	—	37076	37083	37269
5/8	1-1/4	3-1/2	5/8	.060	37201	37205	—	37077	37084	37270
5/8	1-1/4	3-1/2	5/8	.090	—	—	—	37078	37085	37271
5/8	1-1/4	3-1/2	5/8	.120	—	—	—	37079	37086	37272
5/8	1-1/4	3-1/2	5/8	.190	—	—	—	37080	37087	37273
3/4	7/8	4	3/4	.030	—	38599	—	37089	37096	37275
3/4	7/8	4	3/4	.060	—	—	—	37090	37097	37276
3/4	7/8	4	3/4	.090	—	—	—	37091	37098	37277
3/4	7/8	4	3/4	.120	—	—	—	37092	37099	37278
3/4	7/8	4	3/4	.190	—	—	—	37093	37100	37279
3/4	7/8	4	3/4	.250	—	—	—	37094	37101	37280
3/4	1-1/2	4	3/4	.030	37207	37211	—	37103	37110	37282
3/4	1-1/2	4	3/4	.060	37208	37212	—	37104	37111	37283
3/4	1-1/2	4	3/4	.090	—	—	—	37105	37112	37284
3/4	1-1/2	4	3/4	.120	37209	37213	—	37106	37113	37285
3/4	1-1/2	4	3/4	.190	—	—	—	37107	37114	37286
3/4	1-1/2	4	3/4	.250	—	—	—	37108	37115	37287
1	1-1/8	4	1	.030	—	38608	—	37117	37124	37289
1	1-1/8	4	1	.060	—	—	—	37118	37125	37290
1	1-1/8	4	1	.090	—	—	—	37119	37126	37291
1	1-1/8	4	1	.120	—	—	—	37120	37127	37292
1	1-1/8	4	1	.190	—	—	—	37121	37128	37293
1	1-1/8	4	1	.250	—	—	—	37122	37129	37294
1	1-1/2	4	1	.030	37215	37219	—	37131	37138	37296
1	1-1/2	4	1	.060	37216	37220	—	37132	37139	37297
1	1-1/2	4	1	.090	—	—	—	37133	37140	37298
1	1-1/2	4	1	.120	37217	37221	—	37134	37141	37299
1	1-1/2	4	1	.190	—	—	—	37135	37142	37300
1	1-1/2	4	1	.250	—	—	—	37136	37143	37301
1	2	4-1/2	1	.030	—	38617	—	37145	37152	37303
1	2	4-1/2	1	.060	—	—	—	37146	37153	37304
1	2	4-1/2	1	.090	—	—	—	37147	37154	37305
1	2	4-1/2	1	.120	—	—	—	37148	37155	37306
1	2	4-1/2	1	.190	—	—	—	37149	37156	37307
1	2	4-1/2	1	.250	—	—	—	37150	37157	37308

TOLERANCES (inch)

- 1/8–1/4 DIAMETER**
 $D_1 = +0.0000/-0.0012$
 $D_2 = h_6$
 $R = +0.0000/-0.0020$
- >1/4–3/8 DIAMETER**
 $D_1 = +0.0000/-0.0016$
 $D_2 = h_6$
 $R = +0.0000/-0.0020$
- >3/8–1 DIAMETER**
 $D_1 = +0.0000/-0.0020$
 $D_2 = h_6$
 $R = +0.0000/-0.0020$

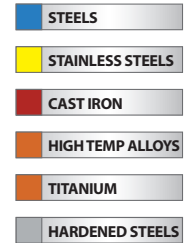

For patent information visit www.ksptpatents.com

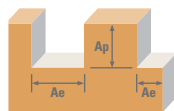

Series	Z5, Z5CR	Hardness	Ae x D ₁	Ap x D ₁	Vc (sfm)	Diameter (D ₁) (inch)								
						1/8	1/4	3/8	1/2	5/8	3/4	1		
P	CARBON STEELS 1018, 1040, 1080, 1090, 10L50, 1140, 1212, 12L15, 1525, 1536	≤ 275 Bhn or ≤ 28 HRc	Profile 	≤ 0.5	≤ 1.5	555	RPM	16961	8480	5654	4240	3392	2827	2120
						(444-666)	Fz	0.00046	0.0012	0.0023	0.0031	0.0034	0.0037	0.0043
							Feed (ipm)	39.0	50.9	65.0	65.7	57.7	52.3	45.6
		Slot 	1	≤ 1	440	RPM	13446	6723	4482	3362	2689	2241	1681	
					(352-528)	Fz	0.00046	0.0012	0.0023	0.0031	0.0034	0.0037	0.0043	
						Feed (ipm)	30.9	40.3	51.5	52.1	45.7	41.5	36.1	
	ALLOY STEELS 4140, 4150, 4320, 5120, 5150, 8630, 86L20, 50100	≤ 375 Bhn or ≤ 40 HRc	Profile 	≤ 0.5	≤ 1.5	315	RPM	9626	4813	3209	2407	1925	1604	1203
						(252-378)	Fz	0.00034	0.0009	0.0017	0.0023	0.0026	0.0028	0.0032
							Feed (ipm)	16.4	21.7	27.3	27.7	25.0	22.5	19.3
		Slot 	1	≤ 1	250	RPM	7640	3820	2547	1910	1528	1273	955	
					(200-300)	Fz	0.00034	0.0009	0.0017	0.0023	0.0026	0.0028	0.0032	
						Feed (ipm)	13.0	17.2	21.6	22.0	19.9	17.8	15.3	
H	TOOL STEELS A2, D2, H13, L2, M2, P20, S7, T15, W2	≤ 375 Bhn or ≤ 40 HRc	Profile 	≤ 0.5	≤ 1.5	185	RPM	5654	2827	1885	1413	1131	942	707
						(148-222)	Fz	0.00028	0.0007	0.0014	0.0018	0.0020	0.0022	0.0026
							Feed (ipm)	7.9	9.9	13.2	12.7	11.3	10.4	9.2
		Slot 	1	≤ 1	145	RPM	4431	2216	1477	1108	886	739	554	
					(116-174)	Fz	0.00028	0.0007	0.0014	0.0018	0.0020	0.0022	0.0026	
						Feed (ipm)	6.2	7.8	10.3	10.0	8.9	8.1	7.2	
K	CAST IRONS (LOW & MEDIUM ALLOY) Gray, Malleable, Ductile	≤ 220 Bhn or ≤ 19 HRc	Profile 	≤ 0.5	≤ 1.5	445	RPM	13599	6800	4533	3400	2720	2267	1700
						(356-534)	Fz	0.00042	0.0011	0.0021	0.0028	0.0031	0.0034	0.0039
							Feed (ipm)	28.6	37.4	47.6	47.6	42.2	38.5	33.1
		Slot 	1	≤ 1	355	RPM	10849	5424	3616	2712	2170	1808	1356	
					(284-426)	Fz	0.00042	0.0011	0.0021	0.0028	0.0031	0.0034	0.0039	
						Feed (ipm)	22.8	29.8	38.0	38.0	33.6	30.7	26.4	
	CAST IRONS (HIGH ALLOY) Gray, Malleable, Ductile	≤ 260 Bhn or ≤ 26 HRc	Profile 	≤ 0.5	≤ 1.5	340	RPM	10390	5195	3463	2598	2078	1732	1299
						(272-408)	Fz	0.00031	0.0008	0.0016	0.0021	0.0023	0.0025	0.0029
							Feed (ipm)	16.1	21.8	27.7	27.3	23.9	21.6	18.8
		Slot 	1	≤ 1	270	RPM	8251	4126	2750	2063	1650	1375	1031	
					(216-324)	Fz	0.00031	0.0008	0.0016	0.0021	0.0023	0.0025	0.0029	
						Feed (ipm)	12.8	17.3	22.0	21.7	19.0	17.2	15.0	
M	STAINLESS STEELS (FREE MACHINING) 303, 416, 420F, 430F, 440F	≤ 275 Bhn or ≤ 28 HRc	Profile 	≤ 0.5	≤ 1.5	490	RPM	14974	7487	4991	3744	2995	2496	1872
						(392-588)	Fz	0.00034	0.0009	0.0017	0.0023	0.0026	0.0028	0.0032
							Feed (ipm)	25.5	33.7	42.4	43.1	38.9	34.9	29.9
		Slot 	1	≤ 1	390	RPM	11918	5959	3973	2980	2384	1986	1490	
					(312-468)	Fz	0.00034	0.0009	0.0017	0.0023	0.0026	0.0028	0.0032	
						Feed (ipm)	20.3	26.8	33.8	34.3	31.0	27.8	23.8	
	STAINLESS STEELS (DIFFICULT) 304, 304L, 316, 316L	≤ 275 Bhn or ≤ 28 HRc	Profile 	≤ 0.5	≤ 1.5	340	RPM	10390	5195	3463	2598	2078	1732	1299
						(272-408)	Fz	0.00027	0.0007	0.0014	0.0018	0.0020	0.0022	0.0025
							Feed (ipm)	14.0	18.2	24.2	23.4	20.8	19.0	16.2
		Slot 	1	≤ 1	270	RPM	8251	4126	2750	2063	1650	1375	1031	
					(216-324)	Fz	0.00027	0.0007	0.0014	0.0018	0.0020	0.0022	0.0025	
						Feed (ipm)	11.1	14.4	19.3	18.6	16.5	15.1	12.9	

continued on next page

FRACTIONAL Z-Carb-HPR

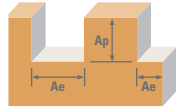

Series Z5, Z5CR Fractional	Hardness	Profile Ae x D1	Ap x D1	Vc (sfm)	Diameter (D1) (inch)							
					1/8	1/4	3/8	1/2	5/8	3/4	1	
M STAINLESS STEELS (PH) 13-8 PH, 15-5 PH, 17-4 PH, Custom 450	≤ 325 Bhn or ≤ 35 HRc	Profile ≤ 0.5	≤ 1.5	310	RPM	9474	4737	3158	2368	1895	1579	1184
				(248-372)	Fz	0.00027	0.0007	0.0014	0.0018	0.0020	0.0022	0.0025
				Feed (ipm)	12.8	16.6	22.1	21.3	18.9	17.4	14.8	
		Slot 1	≤ 1	250	RPM	7640	3820	2547	1910	1528	1273	955
				(200-300)	Fz	0.00027	0.0007	0.0014	0.0018	0.0020	0.0022	0.0025
				Feed (ipm)	10.3	13.4	17.8	17.2	15.3	14.0	11.9	
S SUPER ALLOYS (NICKEL, COBALT, IRON BASE) Inconel 601, 617, 625, Incoloy, Monel 400	≤ 300 Bhn or ≤ 32 HRc	Profile ≤ 0.5	≤ 1.5	80	RPM	2445	1222	815	611	489	407	306
				(64-96)	Fz	0.00025	0.00068	0.00128	0.00170	0.00187	0.00204	0.00238
				Feed (ipm)	3.1	4.2	5.2	5.2	4.6	4.2	3.6	
		Slot 1	≤ 1	65	RPM	1986	993	662	497	397	331	248
				(52-78)	Fz	0.00025	0.00068	0.00128	0.00170	0.00187	0.00204	0.00238
				Feed (ipm)	2.5	3.4	4.2	4.2	3.7	3.4	3.0	
S SUPER ALLOYS (NICKEL, COBALT, IRON BASE) Inconel 718, X-750, Incoloy, Waspaloy, Hastelloy, Rene	≤ 400 Bhn or ≤ 43 HRc	Profile ≤ 0.5	≤ 1.5	62	RPM	1895	947	632	474	379	316	237
				(50-74)	Fz	0.00018	0.00048	0.00090	0.00120	0.00130	0.00140	0.00170
				Feed (ipm)	1.7	2.3	2.8	2.8	2.5	2.2	2.0	
		Slot 1	≤ 1	50	RPM	1528	764	509	382	306	255	191
				(40-60)	Fz	0.00018	0.00048	0.00090	0.00120	0.00130	0.00140	0.00170
				Feed (ipm)	1.4	1.8	2.3	2.3	2.0	1.8	1.6	
S TITANIUM ALLOYS Pure Titanium, Ti6Al4V, Ti6Al2Sn4Zr2Mo, Ti4Al4Mo2Sn0.5Si	≤ 350 Bhn or ≤ 38 HRc	Profile ≤ 0.5	≤ 1.5	215	RPM	6570	3285	2190	1643	1314	1095	821
				(172-258)	Fz	0.0003	0.0008	0.0015	0.0020	0.0022	0.0024	0.0028
				Feed (ipm)	9.9	13.1	16.4	16.4	14.5	13.1	11.5	
		Slot 1	≤ 1	170	RPM	5195	2598	1732	1299	1039	866	649
				(136-204)	Fz	0.0003	0.0008	0.0015	0.0020	0.0022	0.0024	0.0028
				Feed (ipm)	7.8	10.4	13.0	13.0	11.4	10.4	9.1	
S TITANIUM ALLOYS (DIFFICULT) Ti10Al2Fe3Al, Ti5Al5V5Mo3Cr, Ti7Al4Mo, Ti3Al8V6Cr4Zr4Mo, Ti6Al6V6Sn, Ti15V3 Cr3Sn3Al	≤ 440 Bhn or ≤ 47 HRc	Profile ≤ 0.5	≤ 1.5	75	RPM	2292	1146	764	573	458	382	287
				(60-90)	Fz	0.0003	0.0008	0.0015	0.0020	0.0022	0.0024	0.0028
				Feed (ipm)	3.4	4.6	5.7	5.7	5.0	4.6	4.0	
		Slot 1	≤ 1	60	RPM	1834	917	611	458	367	306	229
				(48-72)	Fz	0.0003	0.0008	0.0015	0.0020	0.0022	0.0024	0.0028
				Feed (ipm)	2.8	3.7	4.6	4.6	4.0	3.7	3.2	

Bhn (Brinell) HRc (Rockwell C)

$$\text{rpm} = \text{Vc} \times 3.82 / D_1$$

$$\text{ipm} = \text{Fz} \times 5 \times \text{rpm}$$

ramp up to 5 degrees using slotting speed and feed rates. Do not plunge.

reduce speed and feed for materials harder than listed

reduce feed and Ae when finish milling (.02 x D1 maximum)

refer to the KYOCERA SGS Tool Wizard® for complete technical information (www.kyocera-sgstool.com)

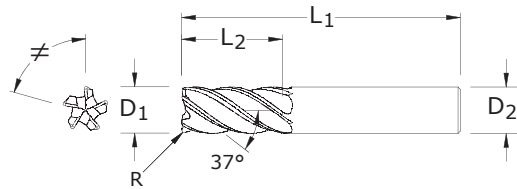
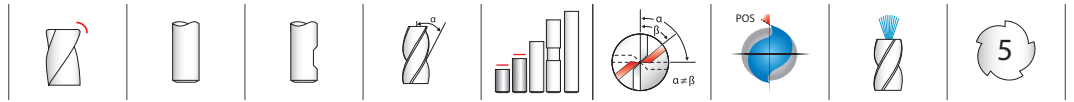

TOLERANCES (mm)

6 DIAMETER

$D_1 = +0,000/-0,030$

$D_2 = h_6$

$R = +0,000/-0,050$

>6-10 DIAMETER

$D_1 = +0,000/-0,040$

$D_2 = h_6$

$R = +0,000/-0,050$

>10-25 DIAMETER

$D_1 = +0,000/-0,050$

$D_2 = h_6$

$R = +0,000/-0,050$

STEELS

STAINLESS STEELS

CAST IRON

HIGH TEMP ALLOYS

TITANIUM

HARDENED STEELS

For patent information visit www.ksptpatents.com

mm					EDP NO.					
CUTTING DIAMETER D_1	LENGTH OF CUT L_2	OVERALL LENGTH L_1	SHANK DIAMETER D_2	CORNER RADIUS R	TI-NAMITE-A (TA)	TI-NAMITE-A (TA) W/FLAT	TI-NAMITE-A (TA) EDP NO. W/INTERNAL COOLANT	TI-NAMITE-M (TM) EDP NO.	TI-NAMITE-M (TM) EDP NO. W/FLAT	TI-NAMITE-M (TM) EDP NO. W/INTERNAL COOLANT
6,0	9,0	54,0	6,0	0,5	-	-	-	47000	-	-
6,0	13,0	57,0	6,0	0,3	-	-	-	47001	-	-
6,0	13,0	57,0	6,0	0,5	47120	48002	-	47002	-	-
6,0	13,0	57,0	6,0	1,0	-	-	-	47003	-	-
6,0	13,0	57,0	6,0	1,5	48003	-	-	47004	-	-
8,0	11,0	58,0	8,0	0,5	-	-	-	47005	-	-
8,0	18,0	63,0	8,0	0,5	47121	-	-	47006	-	-
8,0	18,0	63,0	8,0	1,0	47122	-	-	47007	-	-
8,0	18,0	63,0	8,0	1,5	-	-	-	47008	-	-
8,0	18,0	63,0	8,0	2,0	-	-	-	47009	-	-
10,0	13,0	66,0	10,0	1,0	-	-	-	47010	-	-
10,0	22,0	72,0	10,0	0,5	47123	-	-	47011	-	-
10,0	22,0	72,0	10,0	1,0	47124	-	-	47012	-	-
10,0	22,0	72,0	10,0	1,5	-	-	-	47013	-	-
10,0	22,0	72,0	10,0	2,0	-	-	-	47014	-	-
10,0	22,0	72,0	10,0	2,5	-	-	-	47015	-	-
12,0	15,0	73,0	12,0	1,0	-	-	-	47016	47024	-
12,0	26,0	83,0	12,0	0,5	47125	47128	47160	47017	47025	47161
12,0	26,0	83,0	12,0	0,76	47126	47129	47162	47018	47026	47163
12,0	26,0	83,0	12,0	1,0	47127	47130	47164	47019	47027	47165
12,0	26,0	83,0	12,0	1,5	48012	-	47166	47020	47028	47167
12,0	26,0	83,0	12,0	2,0	-	-	47168	47021	47029	47169
12,0	26,0	83,0	12,0	2,5	-	-	47170	47022	47030	47171
12,0	26,0	83,0	12,0	3,0	-	-	47172	47023	47031	47173
16,0	19,0	82,0	16,0	1,0	-	-	-	47032	47039	47046
16,0	19,0	82,0	16,0	1,5	48070	-	-	-	-	-
16,0	35,0	92,0	16,0	1,0	47131	-	47134	47033	47040	47047
16,0	35,0	92,0	16,0	1,5	-	-	-	47034	47041	47048
16,0	35,0	92,0	16,0	2,0	47132	-	47135	47035	47042	47049
16,0	35,0	92,0	16,0	2,5	-	-	-	47036	47043	47050
16,0	35,0	92,0	16,0	3,0	47133	-	47136	47037	47044	47051
16,0	35,0	92,0	16,0	4,0	-	-	-	47038	47045	47052
20,0	23,0	92,0	20,0	1,0	48020	-	-	47053	47061	47069
20,0	43,0	104,0	20,0	1,0	47137	-	47140	47054	47062	47070
20,0	43,0	104,0	20,0	1,5	-	-	-	47055	47063	47071
20,0	43,0	104,0	20,0	2,0	47138	-	47141	47056	47064	47072
20,0	43,0	104,0	20,0	2,5	-	-	-	47057	47065	47073
20,0	43,0	104,0	20,0	3,0	47139	-	47142	47058	47066	47074
20,0	43,0	104,0	20,0	4,0	-	-	-	47059	47067	47075
20,0	43,0	104,0	20,0	5,0	-	-	-	47060	47068	47076
25,0	28,0	100,0	25,0	1,0	-	-	-	47077	47084	47091
25,0	53,0	121,0	25,0	1,0	47143	-	47146	47078	47085	47092
25,0	53,0	121,0	25,0	2,0	47144	-	47147	47079	47086	47093
25,0	53,0	121,0	25,0	2,5	-	-	-	47080	47087	47094
25,0	53,0	121,0	25,0	3,0	47145	-	47148	47081	47088	47095
25,0	53,0	121,0	25,0	4,0	-	-	-	47082	47089	47096
25,0	53,0	121,0	25,0	5,0	-	-	-	47083	47090	47097

Z5MCR
METRIC SERIES

- An ideal balance of helix, indexing, flute depth, rake and relief
- Variable indexing for chatter suppression and proprietary edge geometry for shearing and strength
- Chatter-free geometry allows deep cutting and high speed machining
- Central coolant hole delivers coolant effectively to the cutting zone enhancing chip removal when pocketing or slotting
- Enhanced corner geometry with tight tolerance corner radii
- Excels at roughing, ramping, high speed machining and finishing in a variety of materials
- Recommended for materials ≤ 45 HRC (≤ 420 Bhn)

Z-Carb-HPR

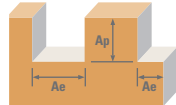

Series Z5MCR	Metric	Hardness	Ae x D ₁	Ap x D ₁	Vc (m/min)	Diameter (D ₁) (mm)								
						6	8	10	12	16	20	25		
P	CARBON STEELS 1018, 1040, 1080, 1090, 10L50, 1140, 1212, 12L15, 1525, 1536	≤ 275 Bhn or ≤ 28 HRc	Profile 	≤ 0.5	≤ 1.5	169	RPM	8967	6725	5380	4484	3363	2690	2152
						(135-203)	Fz	0.029	0.049	0.061	0.074	0.087	0.099	0.108
						Feed (mm/min)	1291	1650	1650	1668	1463	1327	1157	
			Slot 	1	≤ 1	134	RPM	7109	5332	4265	3555	2666	2133	1706
						(107-161)	Fz	0.029	0.049	0.061	0.074	0.087	0.099	0.108
						Feed (mm/min)	1024	1308	1308	1322	1160	1052	917	
	ALLOY STEELS 4140, 4150, 4320, 5120, 5150, 8630, 86L20, 50100	≤ 375 Bhn or ≤ 40 HRc	Profile 	≤ 0.5	≤ 1.5	96	RPM	5089	3817	3054	2545	1909	1527	1221
						(77-115)	Fz	0.022	0.036	0.045	0.055	0.067	0.075	0.080
						Feed (mm/min)	550	692	692	702	635	570	489	
			Slot 	1	≤ 1	76	RPM	4039	3029	2424	2020	1515	1212	969
						(61-91)	Fz	0.022	0.036	0.045	0.055	0.067	0.075	0.080
						Feed (mm/min)	436	549	549	557	504	452	388	
H	TOOL STEELS A2, D2, H13, L2, M2, P20, S7, T15, W2	≤ 375 Bhn or ≤ 40 HRc	Profile 	≤ 0.5	≤ 1.5	56	RPM	2989	2242	1793	1495	1121	897	717
						(45-68)	Fz	0.017	0.030	0.037	0.043	0.051	0.059	0.065
						Feed (mm/min)	251	335	335	323	287	263	233	
			Slot 	1	≤ 1	44	RPM	2343	1757	1406	1171	879	703	562
						(35-53)	Fz	0.017	0.030	0.037	0.043	0.051	0.059	0.065
						Feed (mm/min)	197	262	262	253	225	206	183	
K	CAST IRONS (LOW & MEDIUM ALLOY) Gray, Malleable, Ductile	≤ 220 Bhn or ≤ 19 HRc	Profile 	≤ 0.5	≤ 1.5	136	RPM	7190	5392	4314	3595	2696	2157	1726
						(109-163)	Fz	0.026	0.045	0.056	0.067	0.079	0.091	0.098
						Feed (mm/min)	949	1208	1208	1208	1070	978	841	
			Slot 	1	≤ 1	108	RPM	5736	4302	3441	2868	2151	1721	1377
						(87-130)	Fz	0.026	0.045	0.056	0.067	0.079	0.091	0.098
						Feed (mm/min)	757	964	964	964	853	780	671	
CAST IRONS (HIGH ALLOY) Gray, Malleable, Ductile	≤ 260 Bhn or ≤ 26 HRc	Profile 	≤ 0.5	≤ 1.5	104	RPM	5493	4120	3296	2747	2060	1648	1318	
					(83-124)	Fz	0.020	0.034	0.043	0.050	0.059	0.067	0.073	
					Feed (mm/min)	554	703	703	692	606	549	478		
		Slot 	1	≤ 1	82	RPM	4362	3272	2617	2181	1636	1309	1047	
					(66-99)	Fz	0.020	0.034	0.043	0.050	0.059	0.067	0.073	
					Feed (mm/min)	440	558	558	550	482	436	380		
M	STAINLESS STEELS (FREE MACHINING) 303, 416, 420F, 430F, 440F	≤ 275 Bhn or ≤ 28 HRc	Profile 	≤ 0.5	≤ 1.5	149	RPM	7917	5938	4750	3958	2969	2375	1900
						(119-179)	Fz	0.022	0.036	0.045	0.055	0.067	0.075	0.080
						Feed (mm/min)	855	1077	1077	1092	988	887	760	
			Slot 	1	≤ 1	119	RPM	6301	4726	3781	3151	2363	1890	1512
						(95-143)	Fz	0.022	0.036	0.045	0.055	0.067	0.075	0.080
						Feed (mm/min)	680	857	857	869	786	706	605	
STAINLESS STEELS (DIFFICULT) 304, 304L, 316, 316L	≤ 275 Bhn or ≤ 28 HRc	Profile 	≤ 0.5	≤ 1.5	104	RPM	5493	4120	3296	2747	2060	1648	1318	
					(83-124)	Fz	0.017	0.030	0.037	0.043	0.051	0.059	0.063	
					Feed (mm/min)	461	615	615	593	527	483	412		
		Slot 	1	≤ 1	82	RPM	4362	3272	2617	2181	1636	1309	1047	
					(66-99)	Fz	0.017	0.030	0.037	0.043	0.051	0.059	0.063	
					Feed (mm/min)	366	489	489	471	419	384	327		

continued on next page

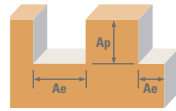

Series Z5MCR	Metric	Hardness	Ae x D ₁	Ap x D ₁	Vc (m/min)	Diameter (D ₁) (mm)											
						6	8	10	12	16	20	25					
M	STAINLESS STEELS (PH) 13-8 PH, 15-5 PH, 17-4 PH, Custom 450	≤ 325 Bhn or ≤ 35 HRc	Profile 	≤ 0.5	≤ 1.5	94	RPM	5009	3756	3005	2504	1878	1503	1202			
						(76-113)	Fz	0.017	0.030	0.037	0.043	0.051	0.059	0.063			
						76	RPM	4039	3029	2424	2020	1515	1212	969			
						(61-91)	Fz	0.017	0.030	0.037	0.043	0.051	0.059	0.063			
							Feed (mm/min)	421	561	561	541	481	441	376			
			Slot 	1	≤ 1	76	RPM	4039	3029	2424	2020	1515	1212	969			
		(61-91)				Fz	0.017	0.030	0.037	0.043	0.051	0.059	0.063				
						Feed (mm/min)	339	452	452	436	388	355	303				
	SUPER ALLOYS (NICKEL, COBALT, IRON BASE) Inconel 601, 617, 625, Incoloy, Monel 400	≤ 300 Bhn or ≤ 32 HRc				Profile 	≤ 0.5	≤ 1.5	24	RPM	1293	969	776	646	485	388	310
(20-29)									Fz	0.0160	0.0272	0.0340	0.0409	0.0478	0.0531	0.0599	
20			RPM	1050	788				630	525	394	315	252				
(16-24)			Fz	0.0160	0.0272				0.0340	0.0409	0.0478	0.0531	0.0599				
			Feed (mm/min)	103	132				132	132	116	103	93				
	SUPER ALLOYS (NICKEL, COBALT, IRON BASE) Inconel 718, X-750, Incoloy, Waspalloy, Hastelloy, Rene	≤ 400 Bhn or ≤ 43 HRc	Profile 	≤ 0.5	≤ 1.5	19	RPM	1002	751	601	501	376	301	240			
(15-23)						Fz	0.0112	0.0192	0.0239	0.0284	0.0333	0.0371	0.0420				
15						RPM	808	606	485	404	303	242	194				
(12-18)						Fz	0.0112	0.0192	0.0239	0.0284	0.0333	0.0371	0.0420				
						Feed (mm/min)	84	107	107	107	94	84	75				
S	TITANIUM ALLOYS Pure Titanium, Ti6Al4V, Ti6Al2Sn4Zr2Mo, Ti4Al4Mo2Sn0.5Si	≤ 350 Bhn or ≤ 38 HRc	Profile 	≤ 0.5	≤ 1.5	66	RPM	3474	2605	2084	1737	1303	1042	834			
						(52-79)	Fz	0.019	0.032	0.040	0.048	0.056	0.064	0.070			
						52	RPM	2747	2060	1648	1373	1030	824	659			
						(41-62)	Fz	0.019	0.032	0.040	0.048	0.056	0.064	0.070			
							Feed (mm/min)	264	330	330	330	290	264	231			
			TITANIUM ALLOYS (DIFFICULT) Ti10Al2Fe3Al, Ti5Al5V5Mo3Cr, Ti7Al4Mo, Ti3Al8V6Cr4Zr4Mo, Ti6Al6V6Sn, Ti15V3 Cr3Sn3Al	≤ 440 Bhn or ≤ 47 HRc	Profile 	≤ 0.5	≤ 1.5	23	RPM	1212	909	727	606	454	364	291	
		(18-27)						Fz	0.019	0.032	0.040	0.048	0.056	0.064	0.071		
		18						RPM	969	727	582	485	364	291	233		
		(15-22)						Fz	0.019	0.032	0.040	0.048	0.056	0.064	0.071		
	Feed (mm/min)	116						145	145	145	128	116	103				
	TITANIUM ALLOYS (DIFFICULT) Ti10Al2Fe3Al, Ti5Al5V5Mo3Cr, Ti7Al4Mo, Ti3Al8V6Cr4Zr4Mo, Ti6Al6V6Sn, Ti15V3 Cr3Sn3Al	≤ 440 Bhn or ≤ 47 HRc	Slot 	1	≤ 1	18	RPM	969	727	582	485	364	291	233			
(15-22)						Fz	0.019	0.032	0.040	0.048	0.056	0.064	0.071				
						Feed (mm/min)	93	116	116	116	102	93	83				

Bhn (Brinell) HRc (Rockwell C)

$$\text{rpm} = (\text{Vc} \times 1000) / (\text{D}_1 \times 3.14)$$

$$\text{mm/min} = \text{Fz} \times 5 \times \text{rpm}$$

ramp up to 5 degrees using slotting speed and feed rates. Do not plunge.

reduce speed and feed for materials harder than listed

reduce feed and Ae when finish milling (.02 x D₁ maximum)

refer to the KYOCERA SGS Tool Wizard® for complete technical information (www.kyocera-sgstool.com)

FRACTIONAL Z-Carb-AP

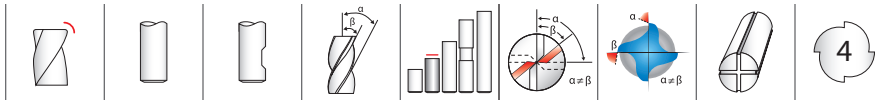

Z1PCR FRACTIONAL SERIES

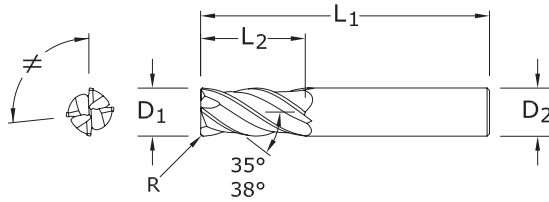

- Variable rake geometry alters and controls the cutting dynamic taking chatter suppression to an unprecedented level
- Unequal helix design changes the cutting angle to improve harmonics
- Unequal flute spacing helps to disrupt the rhythmic pattern created by the cutting edge helping to suppress damaging harmonics
- Enhanced corner geometry with tight tolerance corner radii
- Recommended for materials ≤ 45 HRc (≤ 420 Bhn)

CUTTING DIAMETER D_1	LENGTH OF CUT L_2	inch			EDP NO.		
		OVERALL LENGTH L_1	SHANK DIAMETER D_2	CORNER RADIUS R	Ti-NAMITE-X	Ti-NAMITE-X W/FLAT	JetStream
1/64	1/32	1-1/2	1/8	.002	36874	—	—
1/32	5/64	1-1/2	1/8	.005	36875	—	—
3/64	7/64	1-1/2	1/8	.005	36876	—	—
1/16	3/16	1-1/2	1/8	.005	36872	—	—
5/64	3/16	1-1/2	1/8	.005	36877	—	—
3/32	9/32	1-1/2	1/8	.010	36873	—	—
7/64	3/8	1-1/2	1/8	.010	36878	—	—
1/8	3/8	1-1/2	1/8	.010	36370	—	—
1/8	3/8	1-1/2	1/8	.015	36851	—	—
3/16	7/16	2	3/16	.010	36371	—	—
3/16	7/16	2	3/16	.015	36852	—	—
3/16	7/16	2	3/16	.030	36722	—	—
1/4	1/2	2-1/2	1/4	.010	36372	—	—
1/4	1/2	2-1/2	1/4	.015	36723	—	—
1/4	1/2	2-1/2	1/4	.020	36853	—	—
1/4	1/2	2-1/2	1/4	.030	36373	—	—
1/4	3/4	2-1/2	1/4	.010	36599	—	—
1/4	3/4	2-1/2	1/4	.015	36600	—	—
1/4	3/4	2-1/2	1/4	.020	36854	—	—
1/4	3/4	2-1/2	1/4	.030	36601	—	—
5/16	13/16	2-1/2	5/16	.015	36724	—	—
5/16	13/16	2-1/2	5/16	.020	36855	—	—
5/16	13/16	2-1/2	5/16	.030	36374	—	—
3/8	7/8	2-1/2	3/8	.010	36375	36701	—
3/8	7/8	2-1/2	3/8	.015	36725	36736	—
3/8	7/8	2-1/2	3/8	.020	36856	36864	—
3/8	7/8	2-1/2	3/8	.030	36376	36702	—
3/8	7/8	2-1/2	3/8	.060	36727	36738	—

TOLERANCES (inch)

<1/8 DIAMETER

$D_1 = +0.0005/-0.0005$

$D_2 = h_6$

$R = +0.000/-0.0010$

1/8-1/4 DIAMETER

$D_1 = +0.000/-0.0012$

$D_2 = h_6$

$R = +0.000/-0.0020$

>1/4-3/8 DIAMETER

$D_1 = +0.000/-0.0016$

$D_2 = h_6$

$R = +0.000/-0.0020$

>3/8-1 DIAMETER

$D_1 = +0.000/-0.0020$

$D_2 = h_6$

$R = +0.000/-0.0020$

STEELS

STAINLESS STEELS

CAST IRON

HIGH TEMP ALLOYS

TITANIUM

HARDENED STEELS

For patent information visit www.ksptpatents.com

continued on next page



Z1PCR
FRACTIONAL SERIES

CONTINUED

CUTTING DIAMETER D ₁	LENGTH OF CUT L ₂	inch			EDP NO.		
		OVERALL LENGTH L ₁	SHANK DIAMETER D ₂	CORNER RADIUS R	Ti-NAMITE-X	Ti-NAMITE-X W/FLAT	JetStream
7/16	1	2-3/4	7/16	.020	36857	36865	—
1/2	1	3	1/2	.010	36378	36704	36804
1/2	1	3	1/2	.015	36729	36740	36810
1/2	1	3	1/2	.030	36858	36866	36805
1/2	1	3	1/2	.060	36380	36706	36811
1/2	1	3	1/2	.090	36381	36707	36812
1/2	1	3	1/2	.125	36731	36742	36813
1/2	1-1/4	3-1/4	1/2	.010	36602	36603	—
1/2	1-1/4	3-1/4	1/2	.015	36604	36605	—
1/2	1-1/4	3-1/4	1/2	.030	36859	36867	—
1/2	1-1/4	3-1/4	1/2	.060	36610	36611	—
1/2	1-1/4	3-1/4	1/2	.090	36612	36613	—
1/2	1-1/4	3-1/4	1/2	.125	36614	36615	—
9/16	1-1/8	3-1/2	9/16	.030	36860	36868	36806
5/8	1-1/4	3-1/2	5/8	.030	36383	36709	36814
5/8	1-1/4	3-1/2	5/8	.040	36861	36869	36807
5/8	1-1/4	3-1/2	5/8	.060	36384	36710	36815
5/8	1-1/4	3-1/2	5/8	.090	36385	36711	36816
5/8	1-1/4	3-1/2	5/8	.125	36733	36744	36817
3/4	1-1/2	4	3/4	.030	36386	36712	36818
3/4	1-1/2	4	3/4	.040	36862	36870	36808
3/4	1-1/2	4	3/4	.060	36387	36713	36819
3/4	1-1/2	4	3/4	.090	36388	36714	36820
3/4	1-1/2	4	3/4	.125	36389	36715	36821
1	1-1/2	4	1	.030	36390	36716	36822
1	1-1/2	4	1	.040	36863	36871	36809
1	1-1/2	4	1	.060	36391	36717	36823
1	1-1/2	4	1	.090	36392	36718	36824
1	1-1/2	4	1	.125	36393	36719	36825

FRACTIONAL Z-Carb-AP

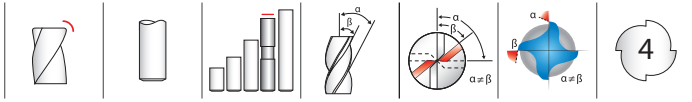

Z1PLC FRACTIONAL SERIES

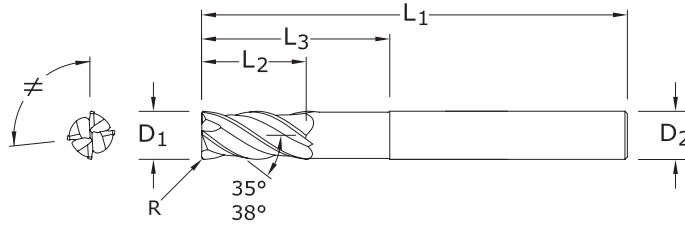

- Variable rake geometry alters and controls the cutting dynamic taking chatter suppression to an unprecedented level
- Unequal helix design changes the cutting angle to improve harmonics
- Unequal flute spacing helps to disrupt the rhythmic pattern created by the cutting edge helping to suppress damaging harmonics
- Long reach design allows for deeper and faster cuts
- Enhanced corner geometry with tight tolerance corner radii
- Recommended for materials ≤ 45 HRc (≤ 420 Bhn)

inch						EDP NO.
CUTTING DIAMETER D_1	LENGTH OF CUT L_2	OVERALL LENGTH L_1	SHANK DIAMETER D_2	REACH L_3	CORNER RADIUS R	Ti-NAMITE-X
1/4	1/2	2-1/2	1/4	1-1/8	.020	36447
1/4	1/2	3-1/2	1/4	1-5/8	.020	36448
1/4	1/2	4	1/4	1-1/4	.020	36450
1/4	1/2	4	1/4	2-1/8	.020	36449
5/16	13/16	3	5/16	1-3/8	.020	36453
5/16	13/16	4	5/16	2	.020	36454
5/16	13/16	4	5/16	1-5/8	.020	36452
3/8	7/8	3	3/8	1-5/8	.020	36457
3/8	7/8	5	3/8	1-7/8	.020	36456
3/8	7/8	4	3/8	2-3/8	.020	36458
7/16	1	6	7/16	2	.020	36460
1/2	1	4	1/2	2	.030	36463
1/2	1	5	1/2	3	.030	36464
1/2	1	6	1/2	2-1/4	.030	36462
9/16	1-1/8	6	9/16	2-1/2	.030	36466
5/8	1-1/4	5	5/8	2-1/2	.040	36468
5/8	1-1/4	6	5/8	3-3/4	.040	36469
5/8	1-1/4	6	5/8	3	.040	36470
3/4	1-1/2	6	3/4	3-1/2	.040	36472
1	1-1/2	6	1	3	.040	36475
1	1-1/2	6	1	4	.040	36474

TOLERANCES (inch)

1/4 DIAMETER

$D_1 = +0.0000/-0.0012$
 $D_2 = h_6$
 $R = +0.0000/-0.0020$

>1/4-3/8 DIAMETER

$D_1 = +0.0000/-0.0016$
 $D_2 = h_6$
 $R = +0.0000/-0.0020$

>3/8-1 DIAMETER

$D_1 = +0.0000/-0.0020$
 $D_2 = h_6$
 $R = +0.0000/-0.0020$

- STEELS
- STAINLESS STEELS
- CAST IRON
- HIGH TEMP ALLOYS
- TITANIUM
- HARDENED STEELS

For patent information visit www.ksptpatents.com

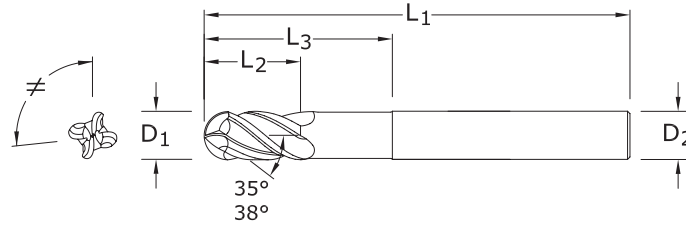
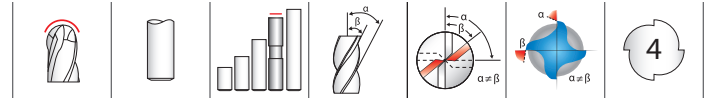

TOLERANCES (inch)

1/4 DIAMETER

$D_1 = +0.0000/-0.0012$

$D_2 = h_6$

BALL RADIUS

$+0.0000/-0.0006$

>1/4-3/8 DIAMETER

$D_1 = +0.0000/-0.0016$

$D_2 = h_6$

BALL RADIUS

$+0.0000/-0.0008$

>3/8-1 DIAMETER

$D_1 = +0.0000/-0.0020$

$D_2 = h_6$

BALL RADIUS

$+0.0000/-0.0010$

STEELS

STAINLESS STEELS

CAST IRON

HIGH TEMP ALLOYS

TITANIUM

HARDENED STEELS

For patent information visit www.ksptpatents.com

Z1PLB
FRACTIONAL SERIES

CUTTING DIAMETER D_1	LENGTH OF CUT L_2	inch			EDP NO. Ti-NAMITE-X
		OVERALL LENGTH L_1	SHANK DIAMETER D_2	REACH L_3	
1/4	1/2	4	1/4	1-1/4	36480
5/16	13/16	4	5/16	1-5/8	36482
3/8	7/8	5	3/8	1-7/8	36486
7/16	1	6	7/16	2	38490
1/2	1	6	1/2	2-1/4	38492
9/16	1-1/8	6	9/16	2-1/2	38496
5/8	1-1/4	6	5/8	3	36500
3/4	1-1/2	6	3/4	3-1/2	36502
1	1-1/2	6	1	4	36504

- Variable rake geometry alters and controls the cutting dynamic taking chatter suppression to an unprecedented level
- Unequal helix design changes the cutting angle to improve harmonics
- Long reach design allows for deeper and faster cuts
- Ball nose design ideal for finishing operations in complex workpieces
- Recommended for materials ≤ 45 HRc (≤ 420 Bhn)

FRACTIONAL Z-Carb-AP

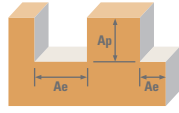

Series Z1PCR, Z1PLC, Z1PLB Fractional	Hardness	Ae x D ₁	Ap x D ₁	Vc (sfm)	Diameter (D ₁) (inch)									
					1/64	1/8	1/4	3/8	1/2	5/8	3/4	1		
P CARBON STEELS 1018, 1040, 1080, 1090, 10L50, 1140, 1212, 12L15, 1525, 1536	≤ 275 Bhn or ≤ 28 HRc	Profile 	≤ 0.5	≤ 1.5	555	RPM	135904	16961	8480	5654	4240	3392	2827	2120
					(444-666)	Fz	0.00005	0.00046	0.0012	0.0023	0.0031	0.0034	0.0037	0.0043
						Feed (ipm)	27.2	31.2	40.7	52.0	52.6	46.1	41.8	36.5
					440	RPM	107744	13446	6723	4482	3362	2689	2241	1681
					(352-528)	Fz	0.00005	0.00046	0.0012	0.0023	0.0031	0.0034	0.0037	0.0043
						Feed (ipm)	21.5	24.7	32.3	41.2	41.7	36.6	33.2	28.9
	≤ 375 Bhn or ≤ 40 HRc	Slot 	1	≤ 1	315	RPM	77135	9626	4813	3209	2407	1925	1604	1203
					(252-378)	Fz	0.00004	0.00034	0.0009	0.0017	0.0023	0.0026	0.0028	0.0032
						Feed (ipm)	12.3	13.1	17.3	21.8	22.1	20.0	18.0	15.4
					250	RPM	61218	7640	3820	2547	1910	1528	1273	955
					(200-300)	Fz	0.00004	0.00034	0.0009	0.0017	0.0023	0.0026	0.0028	0.0032
						Feed (ipm)	9.8	10.4	13.8	17.3	17.6	15.9	14.3	12.2
H TOOL STEELS A2, D2, H13, L2, M2, P20, S7, T15, W2	≤ 375 Bhn or ≤ 40 HRc	Profile 	≤ 0.5	≤ 1.5	185	RPM	45301	5654	2827	1885	1413	1131	942	707
					(148-222)	Fz	0.00003	0.00028	0.0007	0.0014	0.0018	0.0020	0.0022	0.0026
						Feed (ipm)	5.4	6.3	7.9	10.6	10.2	9.0	8.3	7.3
					145	RPM	35506	4431	2216	1477	1108	886	739	554
					(116-174)	Fz	0.00003	0.00028	0.0007	0.0014	0.0018	0.0020	0.0022	0.0026
						Feed (ipm)	4.3	5.0	6.2	8.3	8.0	7.1	6.5	5.8
K CAST IRONS (LOW & MEDIUM ALLOY) Gray, Malleable, Ductile	≤ 220 Bhn or ≤ 19 HRc	Profile 	≤ 0.5	≤ 1.5	445	RPM	108968	13599	6800	4533	3400	2720	2267	1700
					(356-534)	Fz	0.00005	0.00042	0.0011	0.0021	0.0028	0.0031	0.0034	0.0039
						Feed (ipm)	21.8	22.8	29.9	38.1	38.1	33.7	30.8	26.5
					355	RPM	86929	10849	5424	3616	2712	2170	1808	1356
					(284-426)	Fz	0.00005	0.00042	0.0011	0.0021	0.0028	0.0031	0.0034	0.0039
						Feed (ipm)	17.4	18.2	23.9	30.4	30.4	26.9	24.6	21.2
	≤ 260 Bhn or ≤ 26 HRc	Slot 	1	≤ 1	340	RPM	83256	10390	5195	3463	2598	2078	1732	1299
					(272-408)	Fz	0.00004	0.00031	0.0008	0.0016	0.0021	0.0023	0.0025	0.0029
						Feed (ipm)	13.3	12.9	17.5	22.2	21.8	19.1	17.3	15.1
					270	RPM	66115	8251	4126	2750	2063	1650	1375	1031
					(216-324)	Fz	0.00004	0.00031	0.0008	0.0016	0.0021	0.0023	0.0025	0.0029
						Feed (ipm)	10.6	10.2	13.9	17.6	17.3	15.2	13.8	12.0
M STAINLESS STEELS (FREE MACHINING) 303, 416, 420F, 430F, 440F	≤ 275 Bhn or ≤ 28 HRc	Profile 	≤ 0.5	≤ 1.5	490	RPM	119987	14974	7487	4991	3744	2995	2496	1872
					(392-588)	Fz	0.00004	0.00034	0.0009	0.0017	0.0023	0.0026	0.0028	0.0032
						Feed (ipm)	19.2	20.4	27.0	33.9	34.4	31.1	28.0	24.0
					390	RPM	95500	11918	5959	3973	2980	2384	1986	1490
					(312-468)	Fz	0.00004	0.00034	0.0009	0.0017	0.0023	0.0026	0.0028	0.0032
						Feed (ipm)	15.3	16.2	21.5	27.0	27.4	24.8	22.2	19.1

continued on next page

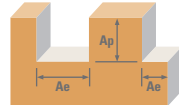

Series Z1PCR, Z1PLC, Z1PLB Fractional	Hardness	Ae x D ₁	Ap x D ₁	Vc (sfm)	Diameter (D ₁) (inch)										
					1/64	1/8	1/4	3/8	1/2	5/8	3/4	1			
M	STAINLESS STEELS (DIFFICULT) 304, 304L, 316, 316L	≤ 275 Bhn or ≤ 28 HRc	Profile 	≤ 0.5	≤ 1.5	340	RPM	83256	10390	5195	3463	2598	2078	1732	1299
						(272-408)	Fz	0.00003	0.00027	0.0007	0.0014	0.0018	0.0020	0.0022	0.0025
						Feed (ipm)	10.0	11.2	14.5	19.4	18.7	16.6	15.2	13.0	
			Slot 	1	≤ 1	270	RPM	66115	8251	4126	2750	2063	1650	1375	1031
						(216-324)	Fz	0.00003	0.00027	0.0007	0.0014	0.0018	0.0020	0.0022	0.0025
						Feed (ipm)	7.9	8.9	11.6	15.4	14.9	13.2	12.1	10.3	
	STAINLESS STEELS (PH) 13-8 PH, 15-5 PH, 17-4 PH, Custom 450	≤ 325 Bhn or ≤ 35 HRc	Profile 	≤ 0.5	≤ 1.5	310	RPM	75910	9474	4737	3158	2368	1895	1579	1184
						(248-372)	Fz	0.00003	0.00027	0.0007	0.0014	0.0018	0.0020	0.0022	0.0025
						Feed (ipm)	9.1	10.2	13.3	17.7	17.1	15.2	13.9	11.8	
			Slot 	1	≤ 1	250	RPM	61218	7640	3820	2547	1910	1528	1273	955
						(200-300)	Fz	0.00003	0.00027	0.0007	0.0014	0.0018	0.0020	0.0022	0.0025
						Feed (ipm)	7.3	8.3	10.7	14.3	13.8	12.2	11.2	9.6	
S	SUPER ALLOYS (NICKEL, COBALT, IRON BASE) Inconel 601, 617, 625, Incoloy, Monel 400	≤ 300 Bhn or ≤ 32 HRc	Profile 	≤ 0.5	≤ 1.5	80	RPM	19590	2445	1222	815	611	489	407	306
						(64-96)	Fz	0.00003	0.00025	0.0007	0.0013	0.0017	0.0019	0.0020	0.0024
						Feed (ipm)	2.4	2.4	3.3	4.2	4.2	3.7	3.3	2.9	
			Slot 	1	≤ 1	65	RPM	15917	1986	993	662	497	397	331	248
						(52-78)	Fz	0.00003	0.00025	0.0007	0.0013	0.0017	0.0019	0.0020	0.0024
						Feed (ipm)	1.9	2.0	2.7	3.4	3.4	3.0	2.7	2.4	
	SUPER ALLOYS (NICKEL, COBALT, IRON BASE) Inconel 718, X-750, Incoloy, Waspaloy, Hastelloy, Rene	≤ 400 Bhn or ≤ 43 HRc	Profile 	≤ 0.5	≤ 1.5	62	RPM	15182	1895	947	632	474	379	316	237
						(50-74)	Fz	0.00002	0.00018	0.0005	0.0009	0.0012	0.0013	0.0014	0.0017
						Feed (ipm)	1.2	1.4	1.8	2.3	2.3	2.0	1.8	1.6	
			Slot 	1	≤ 1	50	RPM	12244	1528	764	509	382	306	255	191
						(40-60)	Fz	0.00002	0.00018	0.0005	0.0009	0.0012	0.0013	0.0014	0.0017
						Feed (ipm)	1.0	1.1	1.5	1.8	1.8	1.6	1.4	1.3	
TITANIUM ALLOYS Pure Titanium, Ti6Al4V, Ti6Al2Sn4Zr2Mo, Ti4Al4Mo2Sn0.5Si	≤ 350 Bhn or ≤ 38 HRc	Profile 	≤ 0.5	≤ 1.5	215	RPM	52647	6570	3285	2190	1643	1314	1095	821	
					(172-258)	Fz	0.00003	0.0003	0.0008	0.0015	0.0020	0.0022	0.0024	0.0028	
					Feed (ipm)	6.3	7.9	10.5	13.1	13.1	11.6	10.5	9.2		
		Slot 	1	≤ 1	170	RPM	41628	5195	2598	1732	1299	1039	866	649	
					(136-204)	Fz	0.00003	0.0003	0.0008	0.0015	0.0020	0.0022	0.0024	0.0028	
					Feed (ipm)	5.0	6.2	8.3	10.4	10.4	9.1	8.3	7.3		
TITANIUM ALLOYS (DIFFICULT) Ti10Al2Fe3Al, Ti5Al5V5Mo3Cr, Ti7Al4Mo, Ti3Al8V6Cr4Zr4Mo, Ti6Al6V6Sn, Ti15V3 Cr3Sn3Al	≤ 440 Bhn or ≤ 47 HRc	Profile 	≤ 0.5	≤ 1.5	75	RPM	18365	2292	1146	764	573	458	382	287	
					(60-90)	Fz	0.00003	0.0003	0.0008	0.0015	0.0020	0.0022	0.0024	0.0028	
					Feed (ipm)	2.2	2.8	3.7	4.6	4.6	4.0	3.7	3.2		
		Slot 	1	≤ 1	60	RPM	14692	1834	917	611	458	367	306	229	
					(48-72)	Fz	0.00003	0.0003	0.0008	0.0015	0.0020	0.0022	0.0024	0.0028	
					Feed (ipm)	1.8	2.2	2.9	3.7	3.7	3.2	2.9	2.6		

Bhn (Brinell) HRc (Rockwell C)
 $rpm = Vc \times 3.82 / D_1$
 $ipm = Fz \times 4 \times rpm$
 maximum Slotting Ap for Z1PCR <1/8 diameter and all Z1PLC / Z1PLB is .25 x D₁
 maximum Profile Ae for Z1PCR <1/8 diameter and all Z1PLC / Z1PLB is .20 x D₁
 reduce speed and feed for materials harder than listed
 reduce feed and Ae when finish milling (.02 x D₁ maximum)
 refer to the KYOCERA SGS Tool Wizard® for complete technical information (www.kyocera-sgstool.com)

METRIC Z-Carb-AP

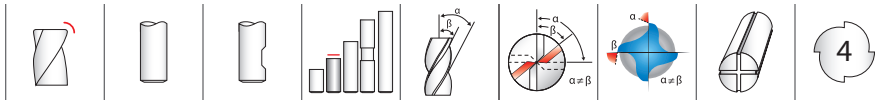

Z1MPCR METRIC SERIES

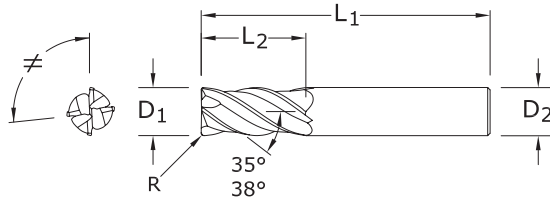

- Variable rake geometry alters and controls the cutting dynamic taking chatter suppression to an unprecedented level
- Unequal helix design changes the cutting angle to improve harmonics
- Unequal flute spacing helps to disrupt the rhythmic pattern created by the cutting edge helping to suppress damaging harmonics
- Enhanced corner geometry with tight tolerance corner radii
- Recommended for materials ≤ 45 HRc (≤ 420 Bhn)

CUTTING DIAMETER D_1	LENGTH OF CUT L_2	mm			EDP NO.		
		OVERALL LENGTH L_1	SHANK DIAMETER D_2	CORNER RADIUS R	Ti-NAMITE-X	Ti-NAMITE-X W/FLAT	JetStream
1,0	3,0	57,0	6,0	0,1	46873	—	—
1,5	4,5	57,0	6,0	0,1	46849	—	—
2,0	6,0	57,0	6,0	0,2	46850	—	—
2,5	7,0	57,0	6,0	0,2	46874	—	—
3,0	8,0	57,0	6,0	0,3	46851	—	—
3,0	8,0	57,0	6,0	0,5	46880	—	—
4,0	11,0	57,0	6,0	0,3	46852	—	—
4,0	11,0	57,0	6,0	0,5	46881	—	—
5,0	13,0	57,0	6,0	0,3	46853	—	—
6,0	13,0	57,0	6,0	0,25	46882	—	—
6,0	13,0	57,0	6,0	0,5	46854	—	—
6,0	13,0	57,0	6,0	1,0	46855	—	—
6,0	13,0	57,0	6,0	1,5	46884	—	—
8,0	19,0	63,0	8,0	0,5	46856	—	—
8,0	19,0	63,0	8,0	1,0	46857	—	—
8,0	19,0	63,0	8,0	1,5	46886	—	—
8,0	19,0	63,0	8,0	2,0	46887	—	—
10,0	22,0	72,0	10,0	0,5	46858	—	—
10,0	22,0	72,0	10,0	1,0	46859	—	—
10,0	22,0	72,0	10,0	1,5	46889	—	—
10,0	22,0	72,0	10,0	2,0	46890	—	—
10,0	22,0	72,0	10,0	2,5	46891	—	—
12,0	26,0	83,0	12,0	0,5	46860	46909	—
12,0	26,0	83,0	12,0	0,75	46861	46910	46493
12,0	26,0	83,0	12,0	1,0	46893	46911	—
12,0	26,0	83,0	12,0	1,5	46894	46912	—
12,0	26,0	83,0	12,0	2,0	46895	46913	—
12,0	26,0	83,0	12,0	2,5	46896	46914	—
12,0	26,0	83,0	12,0	3,0	42718	46915	42719
14,0	26,0	83,0	14,0	1,0	46862	46916	46494
16,0	32,0	92,0	16,0	1,0	46863	46917	46495
16,0	32,0	92,0	16,0	1,5	46898	46918	—
16,0	32,0	92,0	16,0	2,0	46899	46919	—
16,0	32,0	92,0	16,0	2,5	46900	46920	—
16,0	32,0	92,0	16,0	3,0	46864	46921	42721
16,0	32,0	92,0	16,0	4,0	46867	46944	—
20,0	38,0	104,0	20,0	1,0	46865	46922	46497
20,0	38,0	104,0	20,0	1,5	46903	46923	—
20,0	38,0	104,0	20,0	2,0	46904	46924	—
20,0	38,0	104,0	20,0	2,5	46905	46925	—
20,0	38,0	104,0	20,0	3,0	42722	46926	42723
20,0	38,0	104,0	20,0	4,0	46868	46945	—
20,0	38,0	104,0	20,0	5,0	46869	46946	—
25,0	38,0	104,0	25,0	1,0	46866	46927	46498

TOLERANCES (mm)

<3 DIAMETER

$D_1 = +0,012/-0,012$
 $D_2 = h_6$
 $R = +0,000/-0,025$

3-6 DIAMETER

$D_1 = +0,000/-0,030$
 $D_2 = h_6$
 $R = +0,000/-0,050$

>6-10 DIAMETER

$D_1 = +0,000/-0,040$
 $D_2 = h_6$
 $R = +0,000/-0,050$

>10-25 DIAMETER

$D_1 = +0,000/-0,050$
 $D_2 = h_6$
 $R = +0,000/-0,050$

- STEELS
- STAINLESS STEELS
- CAST IRON
- HIGH TEMP ALLOYS
- TITANIUM
- HARDENED STEELS

For patent information visit www.ksptpatents.com

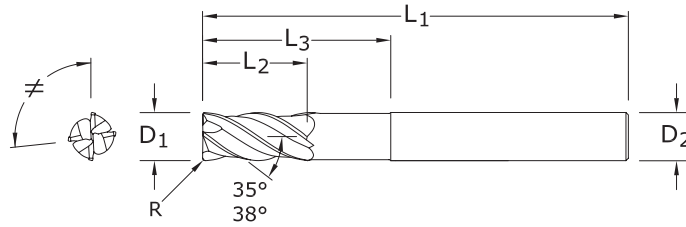
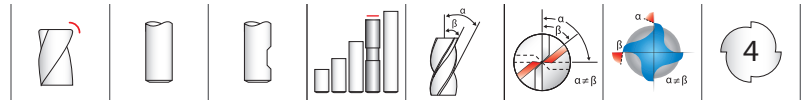

TOLERANCES (mm)

>12-20 DIAMETER

$D_1 = +0,000/-0,050$

$D_2 = h_6$

$R = +0,000/-0,050$

STEELS

STAINLESS STEELS

CAST IRON

HIGH TEMP ALLOYS

TITANIUM

For patent information visit www.ksptpatents.com

Z1MPIC
METRIC SERIES

mm						EDP NO.
CUTTING DIAMETER D_1	LENGTH OF CUT L_2	OVERALL LENGTH L_1	SHANK DIAMETER D_2	REACH L_3	CORNER RADIUS R	Ti-NAMITE-X W/FLAT
12,0	26,0	83,0	12,0	36,0	2,5	42731
12,0	26,0	83,0	12,0	36,0	3,0	42732
12,0	26,0	83,0	12,0	36,0	4,0	42733
16,0	32,0	92,0	16,0	42,0	2,5	42734
16,0	32,0	92,0	16,0	42,0	4,0	42735
16,0	32,0	92,0	16,0	42,0	6,0	42736
20,0	38,0	104,0	20,0	52,0	2,5	42737
20,0	38,0	104,0	20,0	52,0	4,0	42738
20,0	38,0	104,0	20,0	52,0	6,0	42739

- Variable rake geometry alters and controls the cutting dynamic taking chatter suppression to an unprecedented level
- Unequal helix design changes the cutting angle to improve harmonics
- Unequal flute spacing helps to disrupt the rhythmic pattern created by the cutting edge helping to suppress damaging harmonics
- Long reach design allows for deeper and faster cuts
- Enhanced corner geometry with tight tolerance corner radii
- Recommended for materials ≤ 45 HRC (≤ 420 Bhn)

METRIC Z-Carb-AP

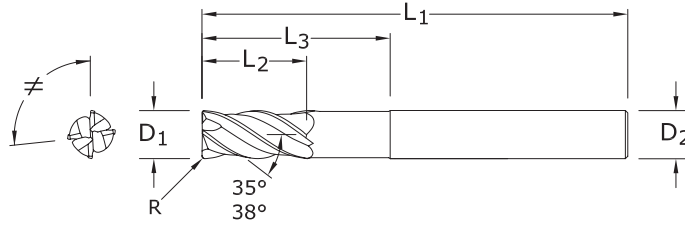
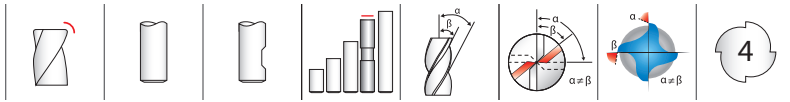

Z1MPLC METRIC SERIES

- Variable rake geometry alters and controls the cutting dynamic taking chatter suppression to an unprecedented level
- Unequal helix design changes the cutting angle to improve harmonics
- Unequal flute spacing helps to disrupt the rhythmic pattern created by the cutting edge helping to suppress damaging harmonics
- Long reach design allows for deeper and faster cuts
- Enhanced corner geometry with tight tolerance corner radii
- Recommended for materials ≤ 45 HRc (≤ 420 Bhn)

CUTTING DIAMETER D_1	LENGTH OF CUT L_2	OVERALL LENGTH L_1	mm			EDP NO.	
			SHANK DIAMETER D_2	REACH L_3	CORNER RADIUS R	Ti-NAMITE-X	Ti-NAMITE-X W/FLAT
6,0	8,0	75,0	6,0	24,0	0,5	46821	—
8,0	10,0	75,0	8,0	32,0	1,0	46822	—
8,0	10,0	75,0	8,0	32,0	2,0	46823	—
10,0	12,0	100,0	10,0	40,0	1,0	46824	—
10,0	12,0	100,0	10,0	40,0	2,0	46825	—
12,0	15,0	100,0	12,0	48,0	1,0	46826	46928
12,0	15,0	100,0	12,0	48,0	1,5	46827	46929
12,0	15,0	100,0	12,0	48,0	2,0	46828	46930
12,0	15,0	100,0	12,0	48,0	3,0	46829	46931
16,0	20,0	115,0	16,0	65,0	1,0	46830	46932
16,0	20,0	115,0	16,0	65,0	1,5	46831	46933
16,0	20,0	115,0	16,0	65,0	2,0	46832	46934
16,0	20,0	115,0	16,0	65,0	3,0	46833	46935
16,0	20,0	115,0	16,0	65,0	4,0	46834	46936
16,0	20,0	115,0	16,0	65,0	5,0	46835	46937
20,0	24,0	140,0	20,0	80,0	1,0	46836	46938
20,0	24,0	140,0	20,0	80,0	1,5	46837	46939
20,0	24,0	140,0	20,0	80,0	2,0	46838	46940
20,0	24,0	140,0	20,0	80,0	3,0	46839	46941
20,0	24,0	140,0	20,0	80,0	4,0	46840	46942
20,0	24,0	140,0	20,0	80,0	5,0	46841	46943

TOLERANCES (mm)

6 DIAMETER

$D_1 = +0,000/-0,030$
 $D_2 = h_6$
 $R = +0,000/-0,050$

>6–10 DIAMETER

$D_1 = +0,000/-0,040$
 $D_2 = h_6$
 $R = +0,000/-0,050$





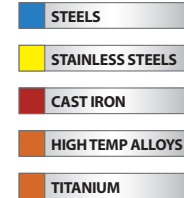

>10–20 DIAMETER

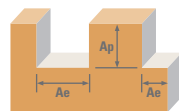
$D_1 = +0,000/-0,050$
 $D_2 = h_6$
 $R = +0,000/-0,050$



For patent information visit www.ksptpatents.com



Series Z1MPCR, Z1MPIC, Z1MPLC Metric	Hardness	Ae x D ₁	Ap x D ₁	Vc (m/min)	Diameter (D ₁) (mm)											
					1	3	6	8	10	12	16	20	25			
P CARBON STEELS 1018, 1040, 1080, 1090, 10L50, 1140, 1212, 12L15, 1525, 1536	≤ 275 Bhn or ≤ 28 HRc	Profile 	≤ 0.5	≤ 1.5	169	RPM	53803	17934	8967	6725	5380	4484	3363	2690	2152	
					(135-203)	Fz	0.0030	0.0109	0.029	0.049	0.061	0.074	0.087	0.099	0.108	
					Feed (mm/min)	646	782	1040	1318	1313	1327	1170	1065	930		
					134	RPM	42654	14218	7109	5332	4265	3555	2666	2133	1706	
					(107-161)	Fz	0.0030	0.0109	0.029	0.049	0.061	0.074	0.087	0.099	0.108	
					Feed (mm/min)	512	620	825	1045	1041	1052	928	845	737		
	ALLOY STEELS 4140, 4150, 4320, 5120, 5150, 8630, 86L20, 50100	≤ 375 Bhn or ≤ 40 HRc	Profile 	≤ 0.5	≤ 1.5	96	RPM	30537	10179	5089	3817	3054	2545	1909	1527	1221
						(77-115)	Fz	0.0023	0.0081	0.022	0.036	0.045	0.055	0.067	0.075	0.080
						Feed (mm/min)	281	330	448	550	550	560	511	458	391	
						76	RPM	24235	8078	4039	3029	2424	2020	1515	1212	969
						(61-91)	Fz	0.0023	0.0081	0.022	0.036	0.045	0.055	0.067	0.075	0.080
						Feed (mm/min)	223	262	355	436	436	444	406	364	310	
H TOOL STEELS A2, D2, H13, L2, M2, P20, S7, T15, W2	≤ 375 Bhn or ≤ 40 HRc	Profile 	≤ 0.5	≤ 1.5	56	RPM	17934	5978	2989	2242	1793	1495	1121	897	717	
					(45-68)	Fz	0.0018	0.0066	0.017	0.030	0.037	0.043	0.051	0.059	0.065	
					Feed (mm/min)	129	158	203	269	265	257	229	212	187		
					44	RPM	14057	4686	2343	1757	1406	1171	879	703	562	
					(35-53)	Fz	0.0018	0.0066	0.017	0.030	0.037	0.043	0.051	0.059	0.065	
					Feed (mm/min)	101	124	159	211	208	201	179	166	146		
K CAST IRONS (LOW & MEDIUM ALLOY) Gray, Malleable, Ductile	≤ 220 Bhn or ≤ 19 HRc	Profile 	≤ 0.5	≤ 1.5	136	RPM	43139	14380	7190	5392	4314	3595	2696	2157	1726	
					(109-163)	Fz	0.0028	0.0099	0.026	0.045	0.056	0.067	0.079	0.091	0.098	
					Feed (mm/min)	483	569	748	971	966	963	852	785	676		
					108	RPM	34414	11471	5736	4302	3441	2868	2151	1721	1377	
					(87-130)	Fz	0.0028	0.0099	0.026	0.045	0.056	0.067	0.079	0.091	0.098	
					Feed (mm/min)	385	454	597	774	771	769	680	626	540		
	CAST IRONS (HIGH ALLOY) Gray, Malleable, Ductile	≤ 260 Bhn or ≤ 26 HRc	Profile 	≤ 0.5	≤ 1.5	104	RPM	32960	10987	5493	4120	3296	2747	2060	1648	1318
						(83-124)	Fz	0.0020	0.0074	0.020	0.034	0.043	0.050	0.059	0.067	0.074
						Feed (mm/min)	264	325	439	560	567	549	486	442	390	
						82	RPM	26174	8725	4362	3272	2617	2181	1636	1309	1047
						(66-99)	Fz	0.0020	0.0074	0.020	0.034	0.043	0.050	0.059	0.067	0.074
						Feed (mm/min)	209	258	349	445	450	436	386	351	310	
M STAINLESS STEELS (FREE MACHINING) 303, 416, 420F, 430F, 440F	≤ 275 Bhn or ≤ 28 HRc	Profile 	≤ 0.5	≤ 1.5	149	RPM	47501	15834	7917	5938	4750	3958	2969	2375	1900	
					(119-179)	Fz	0.0023	0.0081	0.022	0.036	0.045	0.055	0.067	0.075	0.080	
					Feed (mm/min)	437	513	697	855	855	871	796	713	608		
					119	RPM	37807	12602	6301	4726	3781	3151	2363	1890	1512	
					(95-143)	Fz	0.0023	0.0081	0.022	0.036	0.045	0.055	0.067	0.075	0.080	
					Feed (mm/min)	348	408	555	681	681	693	633	567	484		

continued on next page

Z-Carb-AP

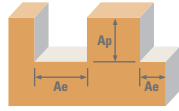

Series Z1MPCR, Z1MPIC, Z1MPLC Metric	Hardness	Ae x D ₁	Ap x D ₁	Vc (m/min)	Diameter (D ₁) (mm)											
					1	3	6	8	10	12	16	20	25			
M	STAINLESS STEELS (DIFFICULT) 304, 304L, 316, 316L	≤ 275 Bhn or ≤ 28 HRc	Profile 	≤ 0.5	≤ 1.5	104	RPM	32960	10987	5493	4120	3296	2747	2060	1648	1318
						(83-124)	Fz	0.0018	0.0064	0.017	0.030	0.037	0.043	0.051	0.059	0.063
						Feed (mm/min)	237	281	374	494	488	472	420	389	332	
			Slot 	1	≤ 1	82	RPM	26174	8725	4362	3272	2617	2181	1636	1309	1047
						(66-99)	Fz	0.0018	0.0064	0.017	0.030	0.037	0.043	0.051	0.059	0.063
						Feed (mm/min)	188	223	297	393	387	375	334	309	264	
	STAINLESS STEELS (PH) 13-8 PH, 15-5 PH, 17-4 PH, Custom 450	≤ 325 Bhn or ≤ 35 HRc	Profile 	≤ 0.5	≤ 1.5	94	RPM	30052	10017	5009	3756	3005	2504	1878	1503	1202
						(76-113)	Fz	0.0018	0.0064	0.017	0.030	0.037	0.043	0.051	0.059	0.063
						Feed (mm/min)	216	256	341	451	445	431	383	355	303	
			Slot 	1	≤ 1	76	RPM	24235	8078	4039	3029	2424	2020	1515	1212	969
						(61-91)	Fz	0.0018	0.0064	0.017	0.030	0.037	0.043	0.051	0.059	0.063
						Feed (mm/min)	174	207	275	364	359	347	309	286	244	
S	SUPER ALLOYS (NICKEL, COBALT, IRON BASE) Inconel 601, 617, 625, Incoloy, Monel 400	≤ 300 Bhn or ≤ 32 HRc	Profile 	≤ 0.5	≤ 1.5	24	RPM	7755	2585	1293	969	776	646	485	388	310
						(20-29)	Fz	0.0018	0.0061	0.016	0.027	0.034	0.041	0.048	0.053	0.060
						Feed (mm/min)	56	63	83	105	105	106	93	82	74	
			Slot 	1	≤ 1	20	RPM	6301	2100	1050	788	630	525	394	315	252
						(16-24)	Fz	0.0018	0.0061	0.016	0.027	0.034	0.041	0.048	0.053	0.060
						Feed (mm/min)	45	51	67	85	86	86	76	67	60	
	SUPER ALLOYS (NICKEL, COBALT, IRON BASE) Inconel 718, X-750, Incoloy, Waspaloy, Hastelloy, Rene	≤ 400 Bhn or ≤ 43 HRc	Profile 	≤ 0.5	≤ 1.5	19	RPM	6010	2003	1002	751	601	501	376	301	240
						(15-23)	Fz	0.0013	0.0043	0.011	0.019	0.024	0.028	0.033	0.037	0.042
						Feed (mm/min)	31	34	44	57	58	56	50	44	40	
			Slot 	1	≤ 1	15	RPM	4847	1616	808	606	485	404	303	242	194
						(12-18)	Fz	0.0013	0.0043	0.011	0.019	0.024	0.028	0.033	0.037	0.042
						Feed (mm/min)	25	28	36	46	47	45	40	36	33	
TITANIUM ALLOYS Pure Titanium, Ti6Al4V, Ti6Al2Sn4Zr2Mo, Ti4Al4Mo2Sn0.5Si	≤ 350 Bhn or ≤ 38 HRc	Profile 	≤ 0.5	≤ 1.5	66	RPM	20842	6947	3474	2605	2084	1737	1303	1042	834	
					(52-79)	Fz	0.0020	0.0071	0.019	0.032	0.040	0.048	0.056	0.064	0.070	
					Feed (mm/min)	167	197	264	333	333	333	292	267	233		
		Slot 	1	≤ 1	52	RPM	16480	5493	2747	2060	1648	1373	1030	824	659	
					(41-62)	Fz	0.0020	0.0071	0.019	0.032	0.040	0.048	0.056	0.064	0.070	
					Feed (mm/min)	132	156	209	264	264	264	231	211	185		
TITANIUM ALLOYS (DIFFICULT) Ti10Al2Fe3Al, Ti5Al5V5Mo3Cr, Ti7Al4Mo, Ti3Al8V6Cr4Zr4Mo, Ti6Al6V6Sn, Ti15V3 Cr3Sn3Al	≤ 440 Bhn or ≤ 47 HRc	Profile 	≤ 0.5	≤ 1.5	23	RPM	7271	2424	1212	909	727	606	454	364	291	
					(18-27)	Fz	0.0020	0.0071	0.019	0.032	0.040	0.048	0.056	0.064	0.070	
					Feed (mm/min)	58	69	92	116	116	116	102	93	81		
		Slot 	1	≤ 1	18	RPM	5816	1939	969	727	582	485	364	291	233	
					(15-22)	Fz	0.0020	0.0071	0.019	0.032	0.040	0.048	0.056	0.064	0.070	
					Feed (mm/min)	47	55	74	93	93	93	81	74	65		

Bhn (Brinell) HRc (Rockwell C)

$rpm = (Vc \times 1000) / (D_1 \times 3.14)$

$ipm = Fz \times 4 \times rpm$

maximum Slotting Ap for Z1PCR <3mm diameter and all Z1MPLC / Z1MPLB is .25 x D₁

maximum Profile Ae for Z1PCR <3mm diameter and all Z1MPLC / Z1MPLB is .20 x D₁

reduce speed and feed for materials harder than listed

reduce feed and Ae when finish milling (.02 x D₁ maximum)

refer to the KYOCERA SGS Tool Wizard® for complete technical information (www.kyocera-sgstool.com)

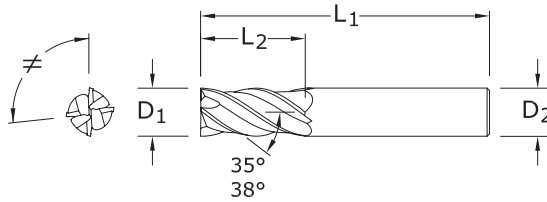
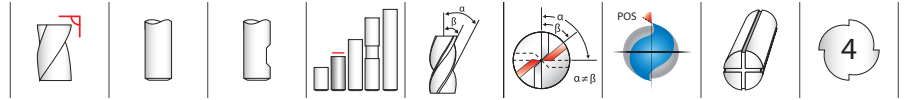

Z1 FRACTIONAL SERIES

TOLERANCES (inch)

1/8–1/4 DIAMETER

$D_1 = +0.0000/-0.0012$

$D_2 = h_6$

>1/4–3/8 DIAMETER

$D_1 = +0.0000/-0.0016$

$D_2 = h_6$

>3/8–1 DIAMETER

$D_1 = +0.0000/-0.0020$

$D_2 = h_6$

STEELS

STAINLESS STEELS

CAST IRON

HIGH TEMP ALLOYS

TITANIUM

HARDENED STEELS

For patent information visit www.ksptpatents.com

inch				EDP NO.		
CUTTING DIAMETER D_1	LENGTH OF CUT L_2	OVERALL LENGTH L_1	SHANK DIAMETER D_2	Ti-NAMITE-A (AlTiN)	Ti-NAMITE-A (AlTiN) W/FLAT	JetStream
1/8	3/8	1-1/2	1/8	36404	—	—
5/32	7/16	2	3/16	36406	—	—
3/16	7/16	2	3/16	36408	—	—
7/32	7/16	2-1/2	1/4	36410	—	—
1/4	1/2	2-1/2	1/4	36416	—	—
1/4	3/4	2-1/2	1/4	36596	—	—
9/32	5/8	2-1/2	5/16	36418	—	—
5/16	13/16	2-1/2	5/16	36420	—	—
11/32	13/16	2-1/2	3/8	36422	—	—
3/8	7/8	2-1/2	3/8	36424	36530	—
13/32	15/16	2-3/4	7/16	36426	36531	—
7/16	1	2-3/4	7/16	36428	36532	—
15/32	1	3	1/2	36430	36533	—
1/2	1	3	1/2	36432	36534	36826
1/2	1-1/4	3-1/4	1/2	36597	36598	—
9/16	1-1/8	3-1/2	9/16	36436	36535	36827
5/8	1-1/4	3-1/2	5/8	36440	36536	36828
3/4	1-1/2	4	3/4	36442	36537	36829
1	1-1/2	4	1	36444	36538	36830

- Unequal helix design aids in damping harmonics by changing the angle at which each cutting edge enters and exits the material
- Unequal flute spacing helps to disrupt the rhythmic pattern created by the cutting edge helping to suppress damaging harmonics
- Optimal material removal rates through increased feed and depths of cut
- Recommended for materials ≤ 45 HRc (≤ 420 Bhn)

FRACTIONAL Z-Carb

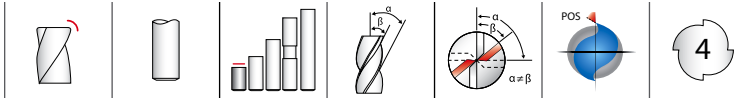

Z16CR FRACTIONAL SERIES

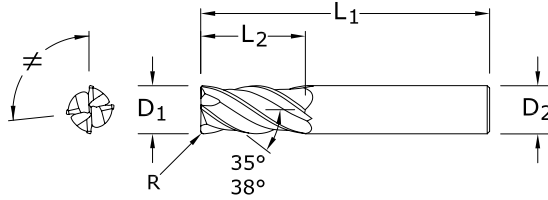

- Unequal helix design aids in damping harmonics by changing the angle at which each cutting edge enters and exits the material
- Unequal flute spacing helps to disrupt the rhythmic pattern created by the cutting edge helping to suppress damaging harmonics
- Optimal material removal rates through increased feed and depths of cut
- Enhanced corner geometry with tight tolerance corner radii
- Recommended for materials ≤ 45 HRc (≤ 420 Bhn)

CUTTING DIAMETER D_1	LENGTH OF CUT L_2	inch		CORNER RADIUS R	EDP NO. TI-NAMITE-X
		OVERALL LENGTH L_1	SHANK DIAMETER D_2		
1/8	1/4	1-1/2	1/8	.015	36505
5/32	5/16	2	3/16	.015	36506
3/16	3/8	2	3/16	.015	36507
7/32	3/8	2	1/4	.020	36508
1/4	7/16	2	1/4	.020	36509
5/16	1/2	2	5/16	.020	36511
3/8	5/8	2	3/8	.020	36513
7/16	5/8	2-1/2	7/16	.020	36515
1/2	5/8	2-1/2	1/2	.030	36517
5/8	3/4	3	5/8	.040	36519
3/4	1	3	3/4	.040	36520

TOLERANCES (inch)

1/8–1/4 DIAMETER

$D_1 = +0.0000/-0.0012$

$D_2 = h_6$

$R = +0.0000/-0.005$

>1/4–3/8 DIAMETER

$D_1 = +0.0000/-0.0016$

$D_2 = h_6$

$R = +0.0000/-0.005$

>3/8–3/4 DIAMETER

$D_1 = +0.0000/-0.0020$

$D_2 = h_6$

$R = +0.0000/-0.005$

STEELS

STAINLESS STEELS

CAST IRON

HIGH TEMP ALLOYS

TITANIUM

HARDENED STEELS

For patent information visit www.kspatents.com

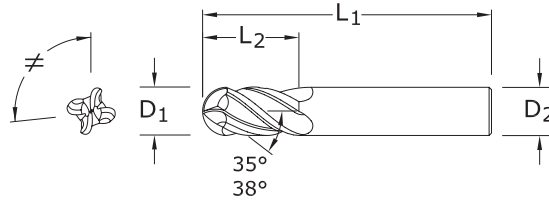
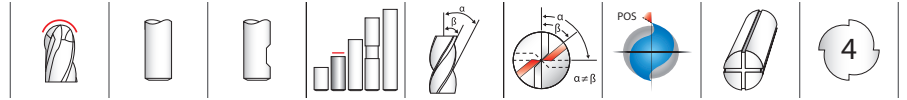

Z1B FRACTIONAL SERIES

TOLERANCES (inch)

1/8–1/4 DIAMETER

$D_1 = +0.0000/-0.0012$

$D_2 = h_6$

BALL RADIUS

$+0.0000/-0.0006$

>1/4–3/8 DIAMETER

$D_1 = +0.0000/-0.0016$

$D_2 = h_6$

BALL RADIUS

$+0.0000/-0.0008$

>3/8–1 DIAMETER

$D_1 = +0.0000/-0.0020$

$D_2 = h_6$

BALL RADIUS

$+0.0000/-0.0010$

STEELS

STAINLESS STEELS

CAST IRON

HIGH TEMP ALLOYS

TITANIUM

HARDENED STEELS









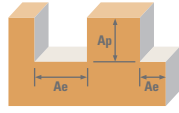



For patent information visit www.ksptpatents.com

inch				EDP NO.		
CUTTING DIAMETER D_1	LENGTH OF CUT L_2	OVERALL LENGTH L_1	SHANK DIAMETER D_2	Ti-NAMITE-X (TX)	Ti-NAMITE-X (TX) W/FLAT	JetStream
1/8	3/8	1-1/2	1/8	36358	—	—
5/32	7/16	2	3/16	36357	—	—
3/16	7/16	2	3/16	36359	—	—
7/32	7/16	2-1/2	1/4	36361	—	—
1/4	1/2	2-1/2	1/4	36344	—	—
1/4	3/4	2-1/2	1/4	36590	—	—
9/32	5/8	2-1/2	5/16	36353	—	—
5/16	13/16	2-1/2	5/16	36345	—	—
11/32	13/16	2-1/2	3/8	36354	—	—
3/8	7/8	2-1/2	3/8	36346	36539	—
13/32	15/16	2-3/4	7/16	36355	36540	—
7/16	1	2-3/4	7/16	36347	36541	—
15/32	1	3	1/2	36356	36542	—
1/2	1	3	1/2	36348	36543	36846
1/2	1-1/4	3-1/4	1/2	36591	36592	—
9/16	1-1/8	3-1/2	9/16	36349	36544	36847
5/8	1-1/4	3-1/2	5/8	36350	36545	36848
3/4	1-1/2	4	3/4	36351	36546	36849
1	1-1/2	4	1	36352	36547	36850

- Unequal helix design aids in damping harmonics by changing the angle at which each cutting edge enters and exits the material
- Unequal flute spacing helps to disrupt the rhythmic pattern created by the cutting edge helping to suppress damaging harmonics
- Optimal material removal rates through increased feed and depths of cut
- Ball nose design ideal for finishing operations in complex workpieces
- Recommended for materials ≤ 45 HRc (≤ 420 Bhn)

FRACTIONAL Z-Carb



Series Z1, Z1B, Z16CR Fractional	Hardness	Profile 	Ae x D ₁	Ap x D ₁	Vc (sfm)	Diameter (D ₁) (inch)								
						1/8	1/4	3/8	1/2	5/8	3/4	1		
P CARBON STEELS 1018, 1040, 1080, 1090, 10L50, 1140, 1212, 12L15, 1525, 1536	≤ 275 Bhn or ≤ 28 HRc	Profile 	≤ 0.5	≤ 1.5	555	RPM	16961	8480	5654	4240	3392	2827	2120	
					(444-666)	Fz	0.0004	0.0010	0.0019	0.0025	0.0031	0.0032	0.0035	
						Feed (ipm)	25.8	33.9	43.0	42.4	42.1	36.5	29.7	
		Slot 	1	≤ 1	440	RPM	13446	6723	4482	3362	2689	2241	1681	
					(352-528)	Fz	0.0004	0.0010	0.0019	0.0025	0.0031	0.0032	0.0035	
						Feed (ipm)	20.4	26.9	34.1	33.6	33.3	29.0	23.5	
	≤ 375 Bhn or ≤ 40 HRc	Profile 	≤ 0.5	≤ 1.5	315	RPM	9626	4813	3209	2407	1925	1604	1203	
					(252-378)	Fz	0.0003	0.0008	0.0014	0.0019	0.0024	0.0025	0.0027	
						Feed (ipm)	10.8	15.4	18.0	18.3	18.5	16.0	13.0	
		Slot 	1	≤ 1	250	RPM	7640	3820	2547	1910	1528	1273	955	
					(200-300)	Fz	0.0003	0.0008	0.0014	0.0019	0.0024	0.0025	0.0027	
						Feed (ipm)	8.6	12.2	14.3	14.5	14.7	12.7	10.3	
H TOOL STEELS A2, D2, H13, L2, M2, P20, S7, T15, W2	≤ 375 Bhn or ≤ 40 HRc	Profile 	≤ 0.5	≤ 1.5	185	RPM	5654	2827	1885	1413	1131	942	707	
					(148-222)	Fz	0.0002	0.0005	0.0010	0.0013	0.0016	0.0017	0.0018	
						Feed (ipm)	4.5	5.7	7.5	7.3	7.2	6.4	5.1	
		Slot 	1	≤ 1	145	RPM	4431	2216	1477	1108	886	739	554	
					(116-174)	Fz	0.0002	0.0005	0.0010	0.0013	0.0016	0.0017	0.0018	
						Feed (ipm)	3.5	4.4	5.9	5.8	5.7	5.0	4.0	
	K CAST IRONS (LOW & MEDIUM ALLOY) Gray, Malleable, Ductile	≤ 220 Bhn or ≤ 19 HRc	Profile 	≤ 0.5	≤ 1.5	445	RPM	13599	6800	4533	3400	2720	2267	1700
						(356-534)	Fz	0.0004	0.0010	0.0018	0.0024	0.0030	0.0031	0.0034
							Feed (ipm)	19.0	27.2	32.6	32.6	32.6	28.1	23.1
			Slot 	1	≤ 1	355	RPM	10849	5424	3616	2712	2170	1808	1356
						(284-426)	Fz	0.0004	0.0010	0.0018	0.0024	0.0030	0.0031	0.0034
							Feed (ipm)	15.2	21.7	26.0	26.0	26.0	22.4	18.4
≤ 260 Bhn or ≤ 26 HRc		Profile 	≤ 0.5	≤ 1.5	340	RPM	10390	5195	3463	2598	2078	1732	1299	
					(272-408)	Fz	0.0003	0.0007	0.0014	0.0018	0.0023	0.0024	0.0025	
						Feed (ipm)	12.5	14.5	19.4	18.7	19.1	16.6	13.0	
		Slot 	1	≤ 1	270	RPM	8251	4126	2750	2063	1650	1375	1031	
					(216-324)	Fz	0.0003	0.0007	0.0014	0.0018	0.0023	0.0024	0.0025	
						Feed (ipm)	9.9	11.6	15.4	14.9	15.2	13.2	10.3	
M STAINLESS STEELS (FREE MACHINING) 303, 416, 420F, 430F, 440F	≤ 275 Bhn or ≤ 28 HRc	Profile 	≤ 0.5	≤ 1.5	490	RPM	14974	7487	4991	3744	2995	2496	1872	
					(392-588)	Fz	0.0003	0.0007	0.0014	0.0018	0.0023	0.0024	0.0025	
						Feed (ipm)	18.0	21.0	28.0	27.0	27.6	24.0	18.7	
		Slot 	1	≤ 1	390	RPM	11918	5959	3973	2980	2384	1986	1490	
					(312-468)	Fz	0.0003	0.0007	0.0014	0.0018	0.0023	0.0024	0.0025	
						Feed (ipm)	14.3	16.7	22.2	21.5	21.9	19.1	14.9	

continued on next page

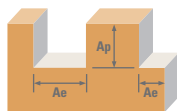

Series Z1, Z1B, Z16CR Fractional	Hardness	Ae x D ₁	Ap x D ₁	Vc (sfm)	Diameter (D ₁) (inch)									
					1/8	1/4	3/8	1/2	5/8	3/4	1			
M	STAINLESS STEELS (DIFFICULT) 304, 304L, 316, 316L	≤ 275 Bhn or ≤ 28 HRc	Profile 	≤ 0.5	≤ 1.5	340	RPM	10390	5195	3463	2598	2078	1732	1299
						(272-408)	Fz	0.0002	0.0006	0.0011	0.0014	0.0018	0.0019	0.0020
						Feed (ipm)	8.3	12.5	15.2	14.5	15.0	13.2	10.4	
			Slot 	1	≤ 1	270	RPM	8251	4126	2750	2063	1650	1375	1031
						(216-324)	Fz	0.0002	0.0006	0.0011	0.0014	0.0018	0.0019	0.0020
						Feed (ipm)	6.6	9.9	12.1	11.6	11.9	10.5	8.3	
	STAINLESS STEELS (PH) 13-8 PH, 15-5 PH, 17-4 PH, Custom 450	≤ 325 Bhn or ≤ 35 HRc	Profile 	≤ 0.5	≤ 1.5	310	RPM	9474	4737	3158	2368	1895	1579	1184
						(248-372)	Fz	0.0002	0.0006	0.0011	0.0014	0.0018	0.0019	0.0020
						Feed (ipm)	7.6	11.4	13.9	13.3	13.6	12.0	9.5	
			Slot 	1	≤ 1	250	RPM	7640	3820	2547	1910	1528	1273	955
						(200-300)	Fz	0.0002	0.0006	0.0011	0.0014	0.0018	0.0019	0.0020
						Feed (ipm)	6.1	9.2	11.2	10.7	11.0	9.7	7.6	
S	SUPER ALLOYS (NICKEL, COBALT, IRON BASE) Inconel 601, 617, 625, Incoloy, Monel 400	≤ 300 Bhn or ≤ 32 HRc	Profile 	≤ 0.5	≤ 1.5	80	RPM	2445	1222	815	611	489	407	306
						(64-96)	Fz	0.0002	0.0004	0.0008	0.0010	0.0013	0.0014	0.0015
						Feed (ipm)	2.2	2.0	2.6	2.4	2.5	2.3	1.8	
			Slot 	1	≤ 1	65	RPM	1986	993	662	497	397	331	248
						(52-78)	Fz	0.0002	0.0004	0.0008	0.0010	0.0013	0.0014	0.0015
						Feed (ipm)	1.6	1.6	2.1	2.0	2.1	1.9	1.5	
	SUPER ALLOYS (NICKEL, COBALT, IRON BASE) Inconel 718, 750-X, Incoloy, Waspaloy, Hastelloy, Rene	≤ 400 Bhn or ≤ 43 HRc	Profile 	≤ 0.5	≤ 1.5	62	RPM	1895	947	632	474	379	316	237
						(50-74)	Fz	0.0001	0.0003	0.0005	0.0007	0.0008	0.0009	0.0010
						Feed (ipm)	0.8	1.1	1.3	1.3	1.2	1.1	0.9	
			Slot 	1	≤ 1	49	RPM	1497	749	499	374	299	250	187
						(39-59)	Fz	0.0001	0.0003	0.0005	0.0007	0.0008	0.0009	0.0010
						Feed (ipm)	0.6	0.9	1.0	1.0	1.0	0.9	0.7	
TITANIUM ALLOYS Pure Titanium, Ti6Al4V, Ti6Al2Sn4Zr2Mo, Ti4Al4Mo2Sn0.5Si	≤ 350 Bhn or ≤ 38 HRc	Profile 	≤ 0.5	≤ 1.5	215	RPM	6570	3285	2190	1643	1314	1095	821	
					(172-258)	Fz	0.0002	0.0005	0.0010	0.0013	0.0016	0.0017	0.0018	
					Feed (ipm)	5.3	6.6	8.8	8.5	8.4	7.4	5.9		
		Slot 	1	≤ 1	170	RPM	5195	2598	1732	1299	1039	866	649	
					(136-204)	Fz	0.0002	0.0005	0.0010	0.0013	0.0016	0.0017	0.0018	
					Feed (ipm)	4.2	5.2	6.9	6.8	6.6	5.9	4.7		
TITANIUM ALLOYS (DIFFICULT) Ti10Al2Fe3Al, Ti5Al5V5Mo3Cr, Ti7Al4Mo, Ti3Al8V6Cr4Zr4Mo, Ti6Al6V6Sn, Ti15V3 Cr3Sn3Al	≤ 440 Bhn or ≤ 47 HRc	Profile 	≤ 0.5	≤ 1.5	75	RPM	2292	1146	764	573	458	382	287	
					(60-90)	Fz	0.0002	0.0005	0.0010	0.0013	0.0016	0.0017	0.0018	
					Feed (ipm)	1.8	2.3	3.1	3.0	2.9	2.6	2.1		
		Slot 	1	≤ 1	60	RPM	1834	917	611	458	367	306	229	
					(48-72)	Fz	0.0002	0.0005	0.0010	0.0013	0.0016	0.0017	0.0018	
					Feed (ipm)	1.5	1.8	2.4	2.4	2.3	2.1	1.7		

Bhn (Brinell) HRc (Rockwell C)

rpm = Vc x 3.82 / D₁

ipm = Fz x 4 x rpm

reduce speed and feed for materials harder than listed

reduce feed and Ae when finish milling (.02 x D₁ maximum)

refer to the KYOCERA SGS Tool Wizard® for complete technical information (www.kyocera-sgstool.com)

METRIC Z-Carb

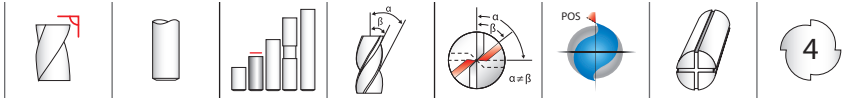

Z1M METRIC SERIES

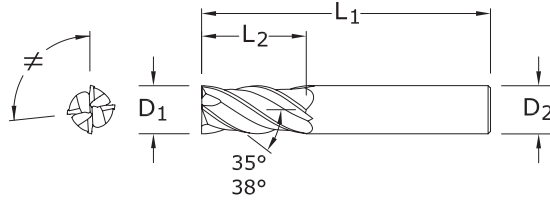

- Unequal helix design aids in damping harmonics by changing the angle at which each cutting edge enters and exits the material
- Unequal flute spacing helps to disrupt the rhythmic pattern created by the cutting edge helping to suppress damaging harmonics
- Optimal material removal rates through increased feed and depths of cut
- Recommended for materials ≤ 45 HRc (≤ 420 Bhn)

CUTTING DIAMETER D_1	mm			EDP NO.	
	LENGTH OF CUT L_2	OVERALL LENGTH L_1	SHANK DIAMETER D_2	Ti-NAMITE-A (AlTiN)	JetStream
3,0	8,0	57,0	6,0	46357	—
4,0	11,0	57,0	6,0	46358	—
5,0	13,0	57,0	6,0	46359	—
6,0	13,0	57,0	6,0	46360	—
8,0	19,0	63,0	8,0	46362	—
10,0	22,0	72,0	10,0	46364	—
12,0	26,0	83,0	12,0	46366	—
14,0	26,0	83,0	14,0	46368	46506
16,0	32,0	92,0	16,0	46370	46507
18,0	32,0	92,0	18,0	46372	46508
20,0	38,0	104,0	20,0	46374	46509
25,0	38,0	104,0	25,0	46376	46510

TOLERANCES (mm)

3–6 DIAMETER

$D_1 = +0,000/-0,030$

$D_2 = h_6$

>6–10 DIAMETER

$D_1 = +0,000/-0,040$

$D_2 = h_6$

>10–25 DIAMETER

$D_1 = +0,000/-0,050$

$D_2 = h_6$

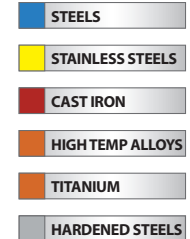

For patent information visit www.ksptpatents.com

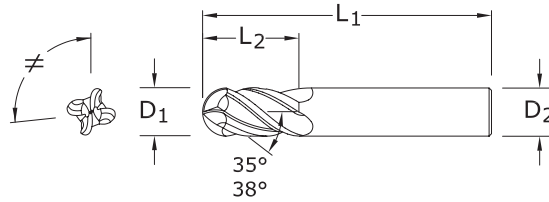
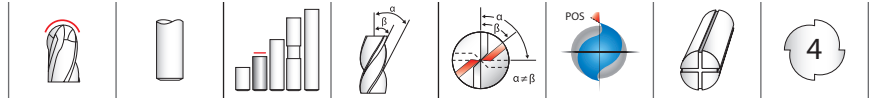

Z1MB
METRIC SERIES

TOLERANCES (mm)

3–6 DIAMETER

$D_1 = +0,000/-0,030$

$D_2 = h_6$

BALL RADIUS

$+0,000/-0,015$

>6–10 DIAMETER

$D_1 = +0,000/-0,040$

$D_2 = h_6$

BALL RADIUS

$+0,000/-0,020$

>10–25 DIAMETER

$D_1 = +0,000/-0,050$

$D_2 = h_6$

BALL RADIUS

$+0,000/-0,025$

STEELS

STAINLESS STEELS

CAST IRON

HIGH TEMP ALLOYS

TITANIUM

HARDENED STEELS

CUTTING DIAMETER D_1	LENGTH OF CUT L_2	OVERALL LENGTH L_1	SHANK DIAMETER D_2	EDP NO.	
				Ti-NAMITE-X (TX)	JetStream
3,0	8,0	57,0	6,0	46354	—
4,0	11,0	57,0	6,0	46355	—
5,0	13,0	57,0	6,0	46356	—
6,0	13,0	57,0	6,0	46343	—
8,0	19,0	63,0	8,0	46344	—
10,0	22,0	72,0	10,0	46345	—
12,0	26,0	83,0	12,0	46346	—
14,0	26,0	83,0	14,0	46347	46518
16,0	32,0	92,0	16,0	46348	46519
18,0	32,0	92,0	18,0	46349	46520
20,0	38,0	104,0	20,0	46350	46521
25,0	38,0	104,0	25,0	46351	46522

- Unequal helix design aids in damping harmonics by changing the angle at which each cutting edge enters and exits the material
- Unequal flute spacing helps to disrupt the rhythmic pattern created by the cutting edge helping to suppress damaging harmonics
- Optimal material removal rates through increased feed and depths of cut
- Ball nose design ideal for finishing operations in complex workpieces
- Recommended for materials ≤ 45 HRc (≤ 420 Bhn)

For patent information visit www.ksptpatents.com

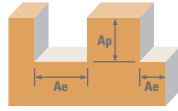

Series Z1M, Z1MB Metric	Hardness	Profile Ae x D ₁	Slot Ap x D ₁	Vc (m/min)	Diameter (D ₁) (mm)								
					3	6	8	10	12	16	20	25	
P	CARBON STEELS 1018, 1040, 1080, 1090, 10L50, 1140, 1212, 12L15, 1525, 1536	Profile ≤ 0.5	≤ 1.5	169	RPM	17934	8967	6725	5380	4484	3363	2690	2152
				(135-203)	Fz	0.009	0.024	0.041	0.051	0.060	0.079	0.086	0.088
				Feed (mm/min)	654	861	1091	1090	1076	1067	927	753	
		Slot 1	≤ 1	134	RPM	14218	7109	5332	4265	3555	2666	2133	1706
				(107-161)	Fz	0.009	0.024	0.041	0.051	0.060	0.079	0.086	0.088
				Feed (mm/min)	519	682	865	864	853	846	735	597	
	ALLOY STEELS 4140, 4150, 4320, 5120, 5150, 8630, 86L20, 50100	Profile ≤ 0.5	≤ 1.5	96	RPM	10179	5089	3817	3054	2545	1909	1527	1221
				(77-115)	Fz	0.007	0.019	0.030	0.037	0.046	0.061	0.067	0.068
				Feed (mm/min)	274	391	456	456	464	469	407	330	
		Slot 1	≤ 1	76	RPM	8078	4039	3029	2424	2020	1515	1212	969
				(61-91)	Fz	0.007	0.019	0.030	0.037	0.046	0.061	0.067	0.068
				Feed (mm/min)	217	310	362	362	368	372	323	262	
H	TOOL STEELS A2, D2, H13, L2, M2, P20, S7, T15, W2	Profile ≤ 0.5	≤ 1.5	56	RPM	5978	2989	2242	1793	1495	1121	897	717
				(45-68)	Fz	0.005	0.012	0.021	0.027	0.031	0.041	0.045	0.045
				Feed (mm/min)	115	143	191	191	186	184	163	129	
		Slot 1	≤ 1	44	RPM	4686	2343	1757	1406	1171	879	703	562
				(35-53)	Fz	0.005	0.012	0.021	0.027	0.031	0.041	0.045	0.045
				Feed (mm/min)	90	112	150	150	146	144	127	101	
K	CAST IRONS (LOW & MEDIUM ALLOY) Gray, Malleable, Ductile	Profile ≤ 0.5	≤ 1.5	136	RPM	14380	7190	5392	4314	3595	2696	2157	1726
				(109-163)	Fz	0.008	0.024	0.038	0.048	0.058	0.077	0.083	0.085
				Feed (mm/min)	483	690	828	828	828	828	713	587	
		Slot 1	≤ 1	108	RPM	11471	5736	4302	3441	2868	2151	1721	1377
				(87-130)	Fz	0.008	0.024	0.038	0.048	0.058	0.077	0.083	0.085
				Feed (mm/min)	385	551	661	661	661	661	569	468	
	CAST IRONS (HIGH ALLOY) Gray, Malleable, Ductile	Profile ≤ 0.5	≤ 1.5	104	RPM	10987	5493	4120	3296	2747	2060	1648	1318
				(83-124)	Fz	0.007	0.017	0.030	0.037	0.043	0.059	0.064	0.063
				Feed (mm/min)	316	369	492	492	475	485	422	330	
		Slot 1	≤ 1	82	RPM	8725	4362	3272	2617	2181	1636	1309	1047
				(66-99)	Fz	0.007	0.017	0.030	0.037	0.043	0.059	0.064	0.063
				Feed (mm/min)	251	293	391	391	377	385	335	262	
M	STAINLESS STEELS (FREE MACHINING) 303, 416, 420F, 430F, 440F	Profile ≤ 0.5	≤ 1.5	149	RPM	15834	7917	5938	4750	3958	2969	2375	1900
				(119-179)	Fz	0.007	0.017	0.030	0.037	0.043	0.059	0.064	0.063
				Feed (mm/min)	456	532	709	709	684	699	608	475	
		Slot 1	≤ 1	119	RPM	12602	6301	4726	3781	3151	2363	1890	1512
				(95-143)	Fz	0.007	0.017	0.030	0.037	0.043	0.059	0.064	0.063
				Feed (mm/min)	363	423	565	565	544	557	484	378	

continued on next page

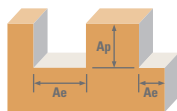

Series Z1M, Z1MB Metric	Hardness	Ae x D ₁	Ap x D ₁	Vc (m/min)	Diameter (D ₁) (mm)										
					3	6	8	10	12	16	20	25			
M	STAINLESS STEELS (DIFFICULT) 304, 304L, 316, 316L	≤ 275 Bhn or ≤ 28 HRc	Profile 	≤ 0.5	≤ 1.5	104	RPM	10987	5493	4120	3296	2747	2060	1648	1318
						(83-124)	Fz	0.005	0.014	0.023	0.029	0.034	0.046	0.051	0.050
							Feed (mm/min)	211	316	387	387	369	380	334	264
						82	RPM	8725	4362	3272	2617	2181	1636	1309	1047
						(66-99)	Fz	0.005	0.014	0.023	0.029	0.034	0.046	0.051	0.050
							Feed (mm/min)	168	251	307	307	293	302	265	209
	STAINLESS STEELS (PH) 13-8 PH, 15-5 PH, 17-4 PH, Custom 450	≤ 325 Bhn or ≤ 35 HRc	Profile 	≤ 0.5	≤ 1.5	94	RPM	10017	5009	3756	3005	2504	1878	1503	1202
						(76-113)	Fz	0.005	0.014	0.023	0.029	0.034	0.046	0.051	0.050
							Feed (mm/min)	192	288	353	353	337	346	305	240
						76	RPM	8078	4039	3029	2424	2020	1515	1212	969
						(61-91)	Fz	0.005	0.014	0.023	0.029	0.034	0.046	0.051	0.050
							Feed (mm/min)	155	233	284	284	271	279	246	194
S	SUPER ALLOYS (NICKEL, COBALT, IRON BASE) Inconel 601, 617, 625, Incoloy, Monel 400	≤ 300 Bhn or ≤ 32 HRc	Profile 	≤ 0.5	≤ 1.5	24	RPM	2585	1293	969	776	646	485	388	310
						(20-29)	Fz	0.005	0.010	0.017	0.021	0.024	0.033	0.037	0.038
							Feed (mm/min)	55	50	66	53	62	65	58	47
						20	RPM	2100	1050	788	630	525	394	315	252
						(16-24)	Fz	0.005	0.010	0.017	0.021	0.024	0.033	0.037	0.038
							Feed (mm/min)	40	40	54	54	50	52	47	38
	SUPER ALLOYS (NICKEL, COBALT, IRON BASE) Inconel 718, X-750, Incoloy, Waspaloy, Hastelloy, Rene	≤ 400 Bhn or ≤ 43 HRc	Profile 	≤ 0.5	≤ 1.5	19	RPM	2003	1002	751	601	501	376	301	240
						(15-23)	Fz	0.002	0.007	0.011	0.013	0.017	0.020	0.024	0.025
							Feed (mm/min)	19	29	32	32	34	31	29	24
						15	RPM	1583	792	594	475	396	297	238	190
						(12-18)	Fz	0.002	0.007	0.011	0.013	0.017	0.020	0.024	0.025
							Feed (mm/min)	15	23	25	25	27	24	23	19
TITANIUM ALLOYS Pure Titanium, Ti6Al4V, Ti6Al2Sn4Zr2Mo, Ti4Al4Mo2Sn0.5Si	≤ 350 Bhn or ≤ 38 HRc	Profile 	≤ 0.5	≤ 1.5	66	RPM	6947	3474	2605	2084	1737	1303	1042	834	
					(52-79)	Fz	0.005	0.012	0.021	0.027	0.031	0.041	0.045	0.045	
						Feed (mm/min)	133	167	222	222	217	213	189	150	
					52	RPM	5493	2747	2060	1648	1373	1030	824	659	
					(41-62)	Fz	0.005	0.012	0.021	0.027	0.031	0.041	0.045	0.045	
						Feed (mm/min)	105	132	176	176	171	169	149	119	
TITANIUM ALLOYS (DIFFICULT) Ti10Al2Fe3Al, Ti5Al5V5Mo3Cr, Ti7Al4Mo, Ti3Al8V6Cr4Zr4Mo, Ti6Al6V6Sn, Ti15V3 Cr3Sn3Al	≤ 440 Bhn or ≤ 47 HRc	Profile 	≤ 0.5	≤ 1.5	23	RPM	2424	1212	909	727	606	454	364	291	
					(18-27)	Fz	0.005	0.012	0.021	0.027	0.031	0.041	0.045	0.045	
						Feed (mm/min)	47	58	78	78	76	74	66	52	
					18	RPM	1939	969	727	582	485	364	291	233	
					(15-22)	Fz	0.005	0.012	0.021	0.027	0.031	0.041	0.045	0.045	
						Feed (mm/min)	37	47	62	62	60	60	53	42	

Bhn (Brinell) HRc (Rockwell C)
 $rpm = (Vc \times 1000) / (D_1 \times 3.14)$
 $ipm = Fz \times 4 \times rpm$
 reduce speed and feed for materials harder than listed
 reduce feed and Ae when finish milling (.02 x D₁ maximum)
 refer to the KYOCERA SGS Tool Wizard® for complete technical information (www.kyocera-sgstool.com)

FRACTIONAL Z-Carb-HTA

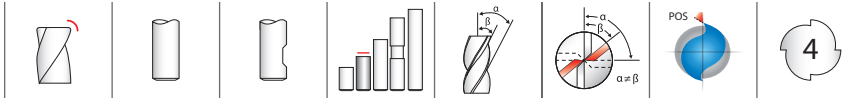

ZH1CR FRACTIONAL SERIES

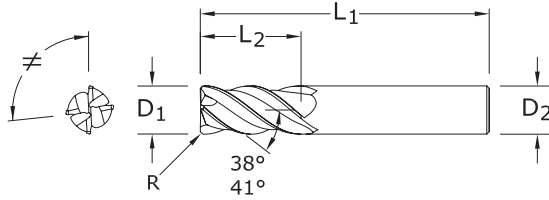

- The original Z-Carb design with an enhanced core and higher helix suited for the demands of high temperature alloys
- Unequal helix design aids in damaging harmonics by changing the angle at which each cutting edge enters and exits the material
- Unequal flute spacing helps to disrupt the rhythmic pattern created by the cutting edge helping to suppress damaging harmonics
- Optimal material removal rates through increased feed and depths of cut for difficult to machine materials
- Enhanced corner geometry with tight tolerance corner radii
- Recommended for materials ≤ 45 HRC (≤ 420 Bhn)

CUTTING DIAMETER D_1	LENGTH OF CUT L_2	inch			EDP NO.	
		OVERALL LENGTH L_1	SHANK DIAMETER D_2	CORNER RADIUS R	Ti-NAMITE-A (AlTiN)	Ti-NAMITE-A (AlTiN) W/FLAT
1/4	1/2	2-1/2	1/4	.020	36570	—
1/4	3/4	2-1/2	1/4	.020	36616	—
5/16	13/16	2-1/2	5/16	.020	36571	—
3/8	7/8	2-1/2	3/8	.020	36572	36555
7/16	1	2-3/4	7/16	.020	36573	36556
1/2	1	3	1/2	.030	36574	36557
1/2	1-1/4	3-1/4	1/2	.030	36618	36617
9/16	1-1/8	3-1/2	9/16	.030	36575	36558
5/8	1-1/4	3-1/2	5/8	.040	36576	36559
3/4	1-1/2	4	3/4	.040	36577	36560
1	1-1/2	4	1	.040	36578	36561

TOLERANCES (inch)

1/4 DIAMETER

$D_1 = +0.0000/-0.0012$
 $D_2 = h_6$
 $R = +0.0000/-0.0020$

>1/4-3/8 DIAMETER

$D_1 = +0.0000/-0.0016$
 $D_2 = h_6$
 $R = +0.0000/-0.0020$

>3/8-1 DIAMETER

$D_1 = +0.0000/-0.0020$
 $D_2 = h_6$
 $R = +0.0000/-0.0020$

HIGH TEMP ALLOYS

TITANIUM

For patent information visit www.ksptpatents.com

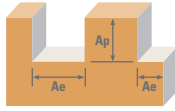

Series ZH1CR Fractional	Hardness	Profile	Ae x D ₁	Ap x D ₁	Vc (sfm)	Diameter (D ₁) (inch)						
						1/4	3/8	1/2	3/4	1		
SUPER ALLOYS (NICKEL, COBALT, IRON BASE) Inconel 601, 617, 625, Incoloy, Monel 400	≤ 300 Bhn or ≤ 32 HRc	Profile	≤ 0.5	≤ 1.5	85	RPM	1299	866	649	433	325	
					(68-102)	Fz	0.0007	0.0012	0.0017	0.0020	0.0023	
		Slot	1	≤ 1	70	RPM	1070	713	535	357	267	
		(56-84)			Fz	0.0007	0.0012	0.0017	0.0020	0.0023		
						Feed (ipm)	3.0	3.4	3.6	2.9	2.5	
	SUPER ALLOYS (NICKEL, COBALT, IRON BASE) Inconel 718, X-750, Incoloy, Waspaloy, Hastelloy, Rene	≤ 400 Bhn or ≤ 43 HRc	Profile	≤ 0.5	≤ 1.5	70	RPM	1070	713	535	357	267
						(56-84)	Fz	0.0005	0.0009	0.0012	0.0014	0.0016
			Slot	1	≤ 1	55	RPM	840	560	420	280	210
			(44-66)			Fz	0.0005	0.0009	0.0012	0.0014	0.0016	
							Feed (ipm)	1.7	2.0	2.0	1.6	1.3
TITANIUM ALLOYS Pure Titanium, Ti6Al4V, Ti6Al2Sn4Zr2Mo, Ti4Al4Mo2Sn0.5Si		≤ 350 Bhn or ≤ 38 HRc	Profile	≤ 0.5	≤ 1.5	215	RPM	3285	2190	1643	1095	821
			(172-258)			Fz	0.0008	0.0015	0.0020	0.0024	0.0028	
		Slot	1	≤ 1	170	RPM	2598	1732	1299	866	649	
		(136-204)			Fz	0.0008	0.0015	0.0020	0.0024	0.0028		
						Feed (ipm)	8.3	10.4	10.4	8.3	7.3	
	TITANIUM ALLOYS (DIFFICULT) Ti10Al2Fe3Al, Ti5Al5V5Mo3Cr, Ti7Al4Mo, Ti3Al8V6Cr4Zr4Mo, Ti6Al6V6Sn, Ti15V3 Cr3Sn3Al	≤ 440 Bhn or ≤ 47 HRc	Profile	≤ 0.5	≤ 1.5	75	RPM	1146	764	573	382	287
			(60-90)			Fz	0.0008	0.0015	0.0020	0.0024	0.0028	
		Slot	1	≤ 1	60	RPM	917	611	458	306	229	
		(48-72)			Fz	0.0008	0.0015	0.0020	0.0024	0.0028		
						Feed (ipm)	2.9	3.7	3.7	2.9	2.6	

Bhn (Brinell) HRc (Rockwell C)

rpm = Vc x 3.82 / D₁

ipm = Fz x 4 x rpm

reduce speed and feed for materials harder than listed

reduce feed and Ae when finish milling (.02 x D₁ maximum)

refer to the KYOCERA SGS Tool Wizard® for complete technical information (www.kyocera-sgstool.com)

Z-Carb-HTA

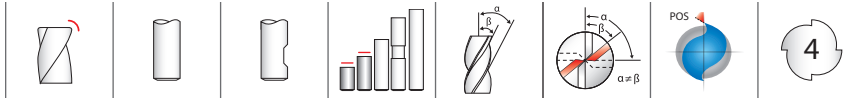

ZH1MCRS

METRIC SERIES

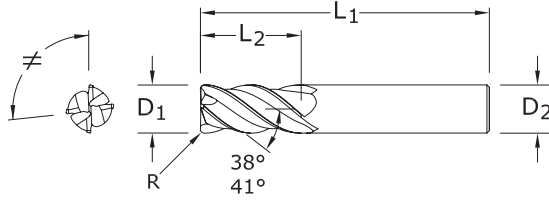

- The original Z-Carb design with an enhanced core and higher helix suited for the demands of high temperature alloys
- Unequal helix design aids in damaging harmonics by changing the angle at which each cutting edge enters and exits the material
- Unequal flute spacing helps to disrupt the rhythmic pattern created by the cutting edge helping to suppress damaging harmonics
- Optimal material removal rates through increased feed and depths of cut for difficult to machine materials
- Enhanced corner geometry with tight tolerance corner radii
- Recommended for materials ≤ 45 HRC (≤ 420 Bhn)

CUTTING DIAMETER D ₁	LENGTH OF CUT L ₂	mm			CORNER RADIUS R	EDP NO. Ti-NAMITE-A (AlTiN)
		OVERALL LENGTH L ₁	SHANK DIAMETER D ₂			
6,0	10,0	54,0	6,0	0,50	42712	
8,0	12,0	58,0	8,0	0,50	42713	
10,0	14,0	66,0	10,0	0,50	42714	
12,0	16,0	73,0	12,0	0,75	42715	
16,0	22,0	82,0	16,0	1,00	42716	
20,0	26,0	92,0	20,0	1,00	42717	

TOLERANCES (mm)

6 DIAMETER

D₁ = +0,000/-0,030
D₂ = h₆
R = +0,000/-0,050

>6-10 DIAMETER

D₁ = +0,000/-0,040
D₂ = h₆
R = +0,000/-0,050

>10-20 DIAMETER

D₁ = +0,000/-0,050
D₂ = h₆
R = +0,000/-0,050

HIGH TEMP ALLOYS

TITANIUM

For patent information visit www.ksptpatents.com

ZH1MCR

METRIC SERIES

- The original Z-Carb design with an enhanced core and higher helix suited for the demands of high temperature alloys
- Unequal helix design aids in damaging harmonics by changing the angle at which each cutting edge enters and exits the material
- Unequal flute spacing helps to disrupt the rhythmic pattern created by the cutting edge helping to suppress damaging harmonics
- Optimal material removal rates through increased feed and depths of cut for difficult to machine materials
- Enhanced corner geometry with tight tolerance corner radii
- Recommended for materials ≤ 45 HRC (≤ 420 Bhn)

CUTTING DIAMETER D ₁	LENGTH OF CUT L ₂	mm			CORNER RADIUS R	EDP NO.	
		OVERALL LENGTH L ₁	SHANK DIAMETER D ₂			Ti-NAMITE-A (AlTiN)	Ti-NAMITE-A (AlTiN) W/FLAT
6,0	13,0	57,0	6,0	0,5	46450	—	
6,0	13,0	57,0	6,0	1,0	46451	—	
6,0	13,0	57,0	6,0	1,5	46452	—	
8,0	19,0	63,0	8,0	0,5	46453	—	
8,0	19,0	63,0	8,0	1,0	46454	—	
8,0	19,0	63,0	8,0	1,5	46455	—	
10,0	22,0	72,0	10,0	0,5	46456	—	
10,0	22,0	72,0	10,0	1,0	46457	—	
10,0	22,0	72,0	10,0	1,5	46458	—	
10,0	22,0	72,0	10,0	2,0	46459	—	
12,0	26,0	83,0	12,0	0,5	46460	46471	
12,0	26,0	83,0	12,0	1,0	46461	46472	
12,0	26,0	83,0	12,0	1,5	46462	46473	
12,0	26,0	83,0	12,0	2,0	46463	46474	
12,0	26,0	83,0	12,0	3,0	46464	46475	
16,0	32,0	92,0	16,0	1,5	46465	46476	
16,0	32,0	92,0	16,0	2,0	46466	46477	
16,0	32,0	92,0	16,0	3,0	46467	46478	
16,0	32,0	92,0	16,0	4,0	46482	46483	
20,0	38,0	104,0	20,0	3,0	46468	46479	
20,0	38,0	104,0	20,0	4,0	46469	46480	
20,0	38,0	104,0	20,0	5,0	46470	46481	

TOLERANCES (mm)

6 DIAMETER

D₁ = +0,000/-0,030
D₂ = h₆
R = +0,000/-0,050

>6-10 DIAMETER

D₁ = +0,000/-0,040
D₂ = h₆
R = +0,000/-0,050

>10-20 DIAMETER









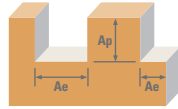

D₁ = +0,000/-0,050
D₂ = h₆
R = +0,000/-0,050

HIGH TEMP ALLOYS

TITANIUM

For patent information visit www.ksptpatents.com



Series ZH1MCRS, ZH1MCR Metric	Hardness	Ae x D ₁	Ap x D ₁	Vc (m/min)	Diameter (D ₁) (mm)					
					6	10	12	20		
SUPER ALLOYS (NICKEL, COBALT, IRON BASE) Inconel 601, 617, 625, Incoloy, Monel 400	≤ 300 Bhn or ≤ 32 HRc	Profile 	≤ 0.5	≤ 1.5	26	RPM	1373	824	687	412
					(21-31)	Fz	0.017	0.032	0.041	0.053
	≤ 300 Bhn or ≤ 32 HRc	Slot 	1	≤ 1	21	RPM	1131	679	565	339
					(17-26)	Fz	0.017	0.032	0.041	0.053
	≤ 300 Bhn or ≤ 32 HRc	Profile 	≤ 0.5	≤ 1.5	21	RPM	1131	679	565	339
					(17-26)	Fz	0.012	0.024	0.029	0.037
	≤ 400 Bhn or ≤ 43 HRc	Slot 	1	≤ 1	17	RPM	889	533	444	267
					(13-20)	Fz	0.012	0.024	0.029	0.037
	≤ 400 Bhn or ≤ 43 HRc	Profile 	≤ 0.5	≤ 1.5	66	RPM	3474	2084	1737	1042
					(52-79)	Fz	0.019	0.041	0.049	0.057
≤ 350 Bhn or ≤ 38 HRc	Slot 	1	≤ 1	52	RPM	2747	1648	1373	824	
				(41-62)	Fz	0.019	0.041	0.049	0.057	
≤ 350 Bhn or ≤ 38 HRc	Profile 	≤ 0.5	≤ 1.5	23	RPM	1212	727	606	364	
				(18-27)	Fz	0.019	0.041	0.049	0.057	
≤ 440 Bhn or ≤ 47 HRc	Slot 	1	≤ 1	18	RPM	969	582	485	291	
				(15-22)	Fz	0.019	0.041	0.049	0.057	
≤ 440 Bhn or ≤ 47 HRc	Profile 	≤ 0.5	≤ 1.5	23	RPM	1212	727	606	364	
				(18-27)	Fz	0.019	0.041	0.049	0.057	
≤ 440 Bhn or ≤ 47 HRc	Slot 	1	≤ 1	18	RPM	969	582	485	291	
				(15-22)	Fz	0.019	0.041	0.049	0.057	

Bhn (Brinell) HRc (Rockwell C)

rpm = (Vc x 1000) / (D₁ x 3.14)

ipm = Fz x 4 x rpm

reduce speed and feed for materials harder than listed

reduce feed and Ae when finish milling (.02 x D₁ maximum)

refer to the KYOCERA SGS Tool Wizard® for complete technical information (www.kyocera-sgstool.com)

FRACTIONAL Z-Carb-MD



ZD1CR FRACTIONAL SERIES

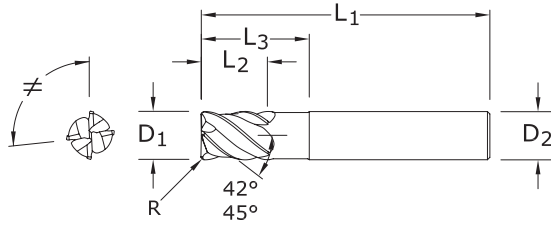

- The original Z-Carb design with negative rake, heavy core, and higher helix for strength and shearing of hard mold & die materials
- Unequal helix design aids in damping harmonics by changing the angle at which each cutting edge enters and exits the material
- Unequal flute spacing helps to disrupt the rhythmic pattern created by the cutting edge helping to suppress damaging harmonics
- Enhanced corner geometry with tight tolerance corner radii
- Recommended for materials 35-60HRc (327 to 654 Bhn)

CUTTING DIAMETER D ₁	LENGTH OF CUT L ₂	OVERALL LENGTH L ₁	inch			CORNER RADIUS R	EDP NO. Ti-NAMITE-X
			SHANK DIAMETER D ₂	REACH L ₃			
1/8	5/32	2-1/2	1/4	1/2	.010	36780	
3/16	7/32	2-1/2	1/4	3/4	.020	36781	
1/4	9/32	2-1/2	1/4	3/4	.020	36782	
5/16	13/32	2-1/2	5/16	1	.040	36783	
3/8	15/32	2-1/2	3/8	1	.040	36784	
7/16	9/16	2-3/4	7/16	1	.040	36785	
1/2	5/8	3	1/2	1-1/4	.040	36786	
1/2	5/8	4-1/2	1/2	2-1/4	.040	36787	
5/8	3/4	3-1/2	5/8	1-1/2	.040	36788	
5/8	3/4	4-1/2	5/8	2-1/4	.040	36789	
5/8	3/4	5-1/2	5/8	3-1/4	.040	36790	
3/4	15/16	4	3/4	1-3/4	.060	36791	
3/4	15/16	4-1/2	3/4	2-1/4	.060	36792	
3/4	15/16	5-1/2	3/4	3-1/4	.060	36793	

TOLERANCES (inch)

1/8-1/4 DIAMETER

D₁ = +0.0000/-0.0012

D₂ = h₆

R = +0.0000/-0.0020

>1/4-3/8 DIAMETER

D₁ = +0.0000/-0.0016

D₂ = h₆

R = +0.0000/-0.0020

>3/8-3/4 DIAMETER

D₁ = +0.0000/-0.0020

D₂ = h₆

R = +0.0000/-0.0020

HARDENED STEELS

For patent information visit
www.ksptpatents.com

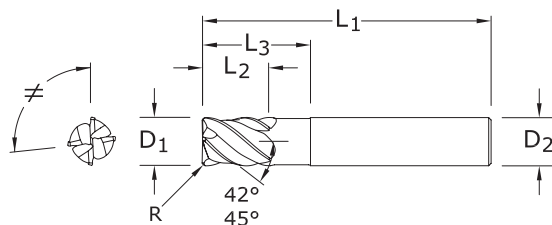

ZD1MCR
METRIC SERIES

TOLERANCES (mm)

3–6 DIAMETER

$D_1 = +0,000/-0,030$

$D_2 = h_6$

$R = +0,000/-0,050$

>6–10 DIAMETER

$D_1 = +0,000/-0,040$

$D_2 = h_6$

$R = +0,000/-0,050$

>10–20 DIAMETER

$D_1 = +0,000/-0,050$

$D_2 = h_6$

$R = +0,000/-0,050$

HARDENED STEELS

For patent information visit www.ksptpatents.com

mm						EDP NO.
CUTTING DIAMETER D_1	LENGTH OF CUT L_2	OVERALL LENGTH L_1	SHANK DIAMETER D_2	REACH L_3	CORNER RADIUS R	Ti-NAMITE-X
3,0	4,0	57,0	6,0	15,0	0,2	46560
4,0	5,0	57,0	6,0	15,0	0,3	46561
5,0	6,0	57,0	6,0	15,0	0,5	46562
6,0	7,0	57,0	6,0	15,0	1,0	46563
8,0	10,0	63,0	8,0	25,0	1,0	46564
10,0	12,0	72,0	10,0	30,0	1,0	46565
12,0	15,0	83,0	12,0	35,0	1,0	46566
16,0	20,0	92,0	16,0	45,0	1,5	46567
20,0	24,0	104,0	20,0	55,0	2,0	46568

- The original Z-Carb design with negative rake, heavy core, and higher helix for strength and shearing of hard mold & die materials
- Unequal helix design aids in damping harmonics by changing the angle at which each cutting edge enters and exits the material
- Unequal flute spacing helps to disrupt the rhythmic pattern created by the cutting edge helping to suppress damaging harmonics
- Enhanced corner geometry with tight tolerance corner radii
- Recommended for materials 35-60HRC (327 to 654 Bhn)

FRACTIONAL & METRIC Z-Carb-MD

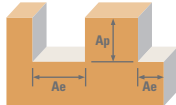

Series ZD1CR Fractional	Hardness	Ae x D ₁	Ap x D ₁	Vc (sfm)	Diameter (D ₁) (inch)							
					1/8	1/4	3/8	1/2	5/8	3/4		
TOOL STEELS A2, D2, H13, L2, M2, P20, S7, T15, W2	≤ 375 Bhn or ≤ 40 HRc	Profile 	≤ 0.4	≤ 1	405	RPM	12377	6188	4126	3094	2475	2063
					(324-486)	Fz	0.0005	0.0012	0.0023	0.0030	0.0039	0.0042
						Feed (ipm)	24.8	29.7	38.0	37.1	38.6	34.7
	≤ 475 Bhn or ≤ 50 HRc	Slot 	1	≤ 0.4	320	RPM	9779	4890	3260	2445	1956	1630
					(256-384)	Fz	0.0005	0.0012	0.0023	0.0030	0.0039	0.0042
						Feed (ipm)	19.6	23.5	30.0	29.3	30.5	27.4
H TOOL STEELS A2, D2, H13, L2, M2, P20, S7, T15, W2	≤ 475 Bhn or ≤ 50 HRc	Profile 	≤ 0.4	≤ 1	210	RPM	6418	3209	2139	1604	1284	1070
					(168-252)	Fz	0.0004	0.0010	0.0019	0.0025	0.0032	0.0035
						Feed (ipm)	10.3	12.8	16.3	16.0	16.4	15.0
	≤ 655 Bhn or ≤ 60 HRc	Slot 	1	≤ 0.4	170	RPM	5195	2598	1732	1299	1039	866
					(136-204)	Fz	0.0004	0.0010	0.0019	0.0025	0.0032	0.0035
						Feed (ipm)	8.3	10.4	13.2	13.0	13.3	12.1
TOOL STEELS A2, D2, H13, L2, M2, P20, S7, T15, W2	≤ 655 Bhn or ≤ 60 HRc	Profile 	≤ 0.4	≤ 1	90	RPM	2750	1375	917	688	550	458
					(72-108)	Fz	0.0002	0.0005	0.0010	0.0013	0.0017	0.0018
						Feed (ipm)	2.2	2.8	3.7	3.6	3.7	3.3
TOOL STEELS A2, D2, H13, L2, M2, P20, S7, T15, W2	≤ 655 Bhn or ≤ 60 HRc	Slot 	1	≤ 0.4	70	RPM	2139	1070	713	535	428	357
					(56-84)	Fz	0.0002	0.0005	0.0010	0.0013	0.0017	0.0018
						Feed (ipm)	1.7	2.1	2.9	2.8	2.9	2.6

Bhn (Brinell) HRc (Rockwell C)

$$\text{rpm} = \text{Vc} \times 3.82 / \text{D}_1$$

$$\text{ipm} = \text{Fz} \times 4 \times \text{rpm}$$

reduce speed and feed for materials harder than listed

reduce feed and Ae when finish milling (.02 x D₁ maximum)

refer to the KYOCERA SGS Tool Wizard® for complete technical information (www.kyocera-sgstool.com)

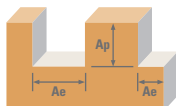

Series ZD1MCR Metric	Hardness	Ae x D ₁	Ap x D ₁	Vc (m/min)	Diameter (D ₁) (mm)								
					3	6	8	10	12	16	20		
TOOL STEELS A2, D2, H13, L2, M2, P20, S7, T15, W2	≤ 375 Bhn or ≤ 40 HRc	Profile 	≤ 0.4	≤ 1	123	RPM	13087	6544	4908	3926	3272	2454	1963
					(99-148)	Fz	0.012	0.029	0.049	0.061	0.072	0.083	0.112
						Feed (mm/min)	628	754	963	963	942	817	879
	≤ 475 Bhn or ≤ 50 HRc	Slot 	1	≤ 0.4	98	RPM	10340	5170	3878	3102	2585	1939	1551
					(78-117)	Fz	0.012	0.029	0.049	0.061	0.072	0.083	0.112
						Feed (mm/min)	496	596	761	761	744	645	695
H TOOL STEELS A2, D2, H13, L2, M2, P20, S7, T15, W2	≤ 475 Bhn or ≤ 50 HRc	Profile 	≤ 0.4	≤ 1	64	RPM	6786	3393	2545	2036	1696	1272	1018
					(51-77)	Fz	0.010	0.024	0.041	0.051	0.060	0.068	0.093
						Feed (mm/min)	261	326	413	413	407	347	380
	≤ 655 Bhn or ≤ 60 HRc	Slot 	1	≤ 0.4	52	RPM	5493	2747	2060	1648	1373	1030	824
					(41-62)	Fz	0.010	0.024	0.041	0.051	0.060	0.068	0.093
						Feed (mm/min)	211	264	334	334	330	281	308
TOOL STEELS A2, D2, H13, L2, M2, P20, S7, T15, W2	≤ 655 Bhn or ≤ 60 HRc	Profile 	≤ 0.4	≤ 1	27	RPM	2908	1454	1091	872	727	545	436
					(22-33)	Fz	0.005	0.012	0.021	0.027	0.031	0.036	0.048
						Feed (mm/min)	56	70	93	93	91	79	84
TOOL STEELS A2, D2, H13, L2, M2, P20, S7, T15, W2	≤ 655 Bhn or ≤ 60 HRc	Slot 	1	≤ 0.4	21	RPM	2262	1131	848	679	565	424	339
					(17-26)	Fz	0.005	0.012	0.021	0.027	0.031	0.036	0.048
						Feed (mm/min)	43	54	72	72	71	62	65

Bhn (Brinell) HRc (Rockwell C)

$$\text{rpm} = (\text{Vc} \times 1000) / (\text{D}_1 \times 3.14)$$

$$\text{ipm} = \text{Fz} \times 4 \times \text{rpm}$$

reduce speed and feed for materials harder than listed

reduce feed and Ae when finish milling (.02 x D₁ maximum)

refer to the KYOCERA SGS Tool Wizard® for complete technical information (www.kyocera-sgstool.com)

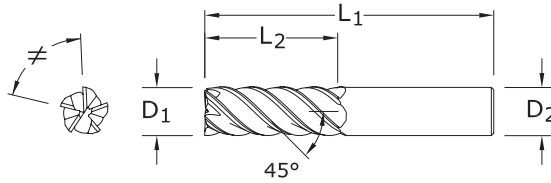
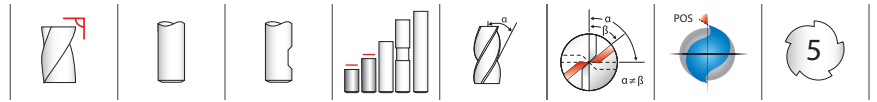

TOLERANCES (inch)

$D_1 = +0.0000/-0.0020$

$D_2 = h_6$

- STEELS
- STAINLESS STEELS
- CAST IRON
- HIGH TEMP ALLOYS
- TITANIUM
- HARDENED STEELS

For patent information visit www.ksptpatents.com

CUTTING DIAMETER D_1	LENGTH OF CUT L_2	OVERALL LENGTH L_1	SHANK DIAMETER D_2	EDP NO.	
				Ti-NAMITE-A (AlTiN)	Ti-NAMITE-A (AlTiN) W/FLAT
1/8	1/4	1-1/2	1/8	32672	—
1/8	1/2	1-1/2	1/8	32655	—
5/32	9/16	2	3/16	32656	—
3/16	5/16	2	3/16	32673	—
3/16	5/8	2	3/16	32657	—
7/32	3/4	2-1/2	1/4	32658	—
1/4	3/8	2	1/4	32674	—
1/4	3/4	2-1/2	1/4	32659	—
5/16	7/16	2	5/16	32675	—
5/16	13/16	2-1/2	5/16	32660	—
3/8	1/2	2	3/8	32676	32677
3/8	1	2-1/2	3/8	32661	32662
7/16	1	2-3/4	7/16	32663	—
1/2	5/8	2-1/2	1/2	32678	32679
1/2	1-1/4	3	1/2	32664	32665
5/8	3/4	3	5/8	32680	32681
5/8	1-5/8	3-1/2	5/8	32666	32667
3/4	1	3	3/4	32682	32683
3/4	1-5/8	4	3/4	32668	32669
1	1-1/2	4	1	32670	32671

55 FRACTIONAL SERIES

- Unequal indexing, high helix and an ideal rake and relief combination for unmatched finishing capability
- The choice when peak finish quality is the requirement
- Recommended for materials ≤ 45 HRC (≤ 420 Bhn)

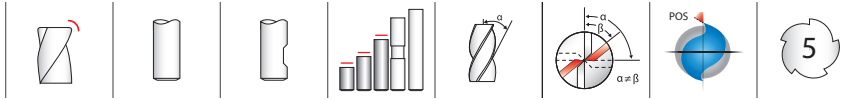

55CR
FRACTIONAL SERIES

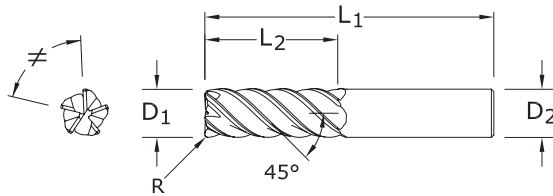

- Unequal indexing, high helix and an ideal rake and relief combination for unmatched finishing capability
- The choice when peak finish quality is the requirement
- Enhanced corner geometry with tight tolerance corner radii
- Recommended for materials ≤ 45 HRc (≤ 420 Bhn)

CUTTING DIAMETER D ₁	LENGTH OF CUT L ₂	inch			EDP NO.	
		OVERALL LENGTH L ₁	SHANK DIAMETER D ₂	CORNER RADIUS R	Ti-NAMITE-A (AITiN)	Ti-NAMITE-A (AITiN) W/FLAT
1/8	1/4	1-1/2	1/8	.010	32606	—
1/8	1/2	1-1/2	1/8	.010	32607	—
5/32	5/16	2	3/16	.010	32608	—
5/32	9/16	2	3/16	.010	32609	—
3/16	5/16	2	3/16	.010	32610	—
3/16	5/8	2	3/16	.010	32611	—
7/32	3/8	2	1/4	.015	32612	—
7/32	3/4	2-1/2	1/4	.015	32613	—
1/4	3/8	2	1/4	.015	32614	—
1/4	3/4	2-1/2	1/4	.015	32615	—
1/4	1-1/4	4	1/4	.015	32616	—
5/16	7/16	2	5/16	.015	32619	—
5/16	13/16	2-1/2	5/16	.015	32620	—
5/16	1-1/4	4	5/16	.015	32621	—
3/8	1/2	2	3/8	.015	32625	32591
3/8	1/2	2	3/8	.030	32592	32593
3/8	1	2-1/2	3/8	.015	32626	32628
3/8	1	2-1/2	3/8	.030	32573	32574
3/8	1-1/2	4	3/8	.015	32627	—
3/8	1-1/2	4	3/8	.030	32569	—
7/16	1	2-3/4	7/16	.015	32632	—
7/16	2	4	7/16	.015	32633	—
1/2	5/8	2-1/2	1/2	.030	32594	32595
1/2	5/8	2-1/2	1/2	.060	32596	32597
1/2	1-1/4	3	1/2	.030	32575	32576
1/2	1-1/4	3	1/2	.060	32577	32578
1/2	2	4	1/2	.030	32685	—
1/2	2	4	1/2	.060	32686	—
5/8	3/4	3	5/8	.030	32598	32599
5/8	3/4	3	5/8	.060	32600	32601
5/8	1-5/8	3-1/2	5/8	.030	32579	32580
5/8	1-5/8	3-1/2	5/8	.060	32581	32582
5/8	2-1/2	5	5/8	.030	32570	—
5/8	2-1/2	5	5/8	.060	32687	—
3/4	1	3	3/4	.030	32602	32603
3/4	1	3	3/4	.060	32604	32605
3/4	1-5/8	4	3/4	.030	32583	32584
3/4	1-5/8	4	3/4	.060	32585	32586
3/4	3-1/4	6	3/4	.030	32571	—
3/4	3-1/4	6	3/4	.060	32688	—
1	1-1/2	4	1	.030	32587	32588
1	1-1/2	4	1	.060	32589	32590
1	2-5/8	6	1	.030	32572	—
1	2-5/8	6	1	.060	32689	—

TOLERANCES (inch)

D₁ = +0.0000/-0.0020

D₂ = h₆

R = +0.0000/-0.0020

- STEELS
- STAINLESS STEELS
- CAST IRON
- HIGH TEMP ALLOYS
- TITANIUM
- HARDENED STEELS

For patent information visit www.ksptpatents.com

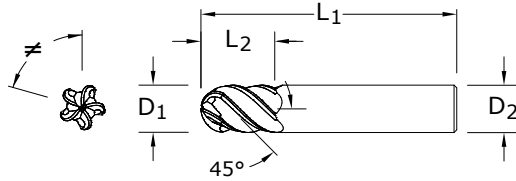
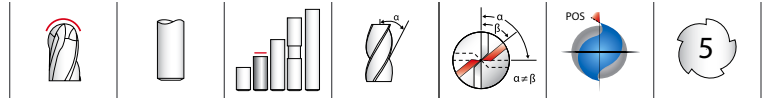

TOLERANCES (inch)

$D_1 = +0.0000/-0.0020$

$D_2 = h_6$

BALL RADIUS

$+0.0005/-0.0010$

STEELS

STAINLESS STEELS

CAST IRON

HIGH TEMP ALLOYS

TITANIUM

HARDENED STEELS

55B

FRACTIONAL SERIES

	inch			EDP NO.
CUTTING DIAMETER D_1	LENGTH OF CUT L_2	OVERALL LENGTH L_1	SHANK DIAMETER D_2	Ti-NAMITE-A (AITiN)
1/4	3/4	2-1/2	1/4	32500
5/16	13/16	2-1/2	5/16	32501
3/8	1	2-1/2	3/8	32502
1/2	1-1/4	3	1/2	32503
5/8	1-5/8	3-1/2	5/8	32504
3/4	1-5/8	4	3/4	32505
1	1-1/2	4	1	32506

- Unequal indexing, high helix and an ideal rake and relief combination for unmatched finishing capability
- The choice when peak finish quality is the requirement
- Ball nose design ideal for finishing operations in complex workpieces
- Recommended for materials ≤ 45 HRc (≤ 420 Bhn)

For patent information visit www.ksptpatents.com

FRACTIONAL V-Carb

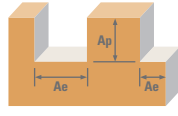

Series	Hardness	Profile	Ae x D ₁	Ap x D ₁	Vc (sfm)	Diameter (D ₁) (inch)							
						1/8	1/4	3/8	1/2	5/8	3/4	1	
P	CARBON STEELS 1018, 1040, 1080, 1090, 10L50, 1140, 1212, 12L15, 1525, 1536	Profile	≤ 0.25	≤ 1.5	385	RPM	11766	5883	3922	2941	2353	1961	1471
					(308-462)	Fz	0.0004	0.0009	0.0017	0.0023	0.0029	0.0028	0.0032
					Feed (ipm)	20.6	26.5	33.3	33.8	34.1	27.5	23.5	
		HSM	≤ 0.05	≤ 2	630	RPM	19253	9626	6418	4813	3851	3209	2407
					(504-756)	Fz	0.0007	0.0018	0.0034	0.0046	0.0057	0.0055	0.0064
					Feed (ipm)	67.4	86.6	109.1	110.7	109.7	88.2	77.0	
	ALLOY STEELS 4140, 4150, 4320, 5120, 5150, 8630, 86L20, 50100	Profile	≤ 0.25	≤ 1.5	325	RPM	9932	4966	3311	2483	1986	1655	1242
					(260-390)	Fz	0.0003	0.0007	0.0013	0.0017	0.0022	0.0021	0.0024
					Feed (ipm)	12.9	17.4	21.5	21.1	21.9	17.4	14.9	
		HSM	≤ 0.05	≤ 2	530	RPM	16197	8098	5399	4049	3239	2699	2025
					(424-636)	Fz	0.0005	0.0014	0.0026	0.0034	0.0043	0.0041	0.0048
					Feed (ipm)	42.1	56.7	70.2	68.8	69.6	55.3	48.6	
H	TOOL STEELS A2, D2, H13, L2, M2, P20, S7, T15, W2	Profile	≤ 0.25	≤ 1.5	175	RPM	5348	2674	1783	1337	1070	891	669
					(140-210)	Fz	0.0002	0.0005	0.0010	0.0013	0.0016	0.0017	0.0018
					Feed (ipm)	5.3	6.7	8.9	8.7	8.6	7.6	6.0	
		HSM	≤ 0.05	≤ 2	290	RPM	8862	4431	2954	2216	1772	1477	1108
					(232-348)	Fz	0.0004	0.0010	0.0019	0.0025	0.0032	0.0033	0.0035
					Feed (ipm)	17.7	22.2	28.1	27.7	28.4	24.4	19.4	
K	CAST IRONS (LOW & MEDIUM ALLOY) Gray, Malleable, Ductile	Profile	≤ 0.25	≤ 1.5	470	RPM	14363	7182	4788	3591	2873	2394	1795
					(376-564)	Fz	0.0004	0.0009	0.0017	0.0023	0.0029	0.0030	0.0032
					Feed (ipm)	25.1	32.3	40.7	41.3	41.7	35.9	28.7	
		HSM	≤ 0.05	≤ 2	705	RPM	21545	10772	7182	5386	4309	3591	2693
					(564-846)	Fz	0.0007	0.0018	0.0034	0.0046	0.0057	0.0059	0.0064
					Feed (ipm)	75.4	97.0	122.1	123.9	122.8	105.9	86.2	
	CAST IRONS (HIGH ALLOY) Gray, Malleable, Ductile	Profile	≤ 0.25	≤ 1.5	360	RPM	11002	5501	3667	2750	2200	1834	1375
					(288-432)	Fz	0.0003	0.0007	0.0013	0.0017	0.0022	0.0023	0.0024
					Feed (ipm)	14.3	19.3	23.8	23.4	24.2	21.1	16.5	
		HSM	≤ 0.05	≤ 2	540	RPM	16502	8251	5501	4126	3300	2750	2063
					(432-648)	Fz	0.0005	0.0014	0.0026	0.0034	0.0043	0.0044	0.0048
					Feed (ipm)	42.9	57.8	71.5	70.1	71.0	60.5	49.5	
M	STAINLESS STEELS (FREE MACHINING) 303, 416, 420F, 430F, 440F	Profile	≤ 0.25	≤ 1.5	370	RPM	11307	5654	3769	2827	2261	1885	1413
					(296-444)	Fz	0.0003	0.0007	0.0013	0.0017	0.0022	0.0023	0.0024
					Feed (ipm)	14.7	19.8	24.5	24.0	24.9	21.7	17.0	
		HSM	≤ 0.05	≤ 2	560	RPM	17114	8557	5705	4278	3423	2852	2139
					(448-672)	Fz	0.0005	0.0014	0.0026	0.0034	0.0043	0.0044	0.0048
					Feed (ipm)	44.5	59.9	74.2	72.7	73.6	62.7	51.3	

continued on next page

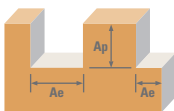

Series	Hardness	Profile	Ae x D ₁	Ap x D ₁	Vc (sfm)	Diameter (D ₁) (inch)							
						1/8	1/4	3/8	1/2	5/8	3/4	1	
M STAINLESS STEELS (DIFFICULT) 304, 304L, 316, 316L	≤ 275 Bhn or ≤ 28 HRc	Profile	≤ 0.25	≤ 1.5	255	RPM	7793	3896	2598	1948	1559	1299	974
					(204-306)	Fz	0.0002	0.0006	0.0012	0.0016	0.0020	0.0021	0.0023
					Feed (ipm)	9.4	11.7	15.6	15.6	15.6	13.6	11.2	
		HSM	≤ 0.05	≤ 2	385	RPM	11766	5883	3922	2941	2353	1961	1471
					(308-462)	Fz	0.0005	0.0013	0.0024	0.0032	0.0040	0.0041	0.0045
					Feed (ipm)	28.2	38.2	47.1	47.1	47.1	40.2	33.1	
	≤ 325 Bhn or ≤ 35 HRc	Profile	≤ 0.25	≤ 1.5	235	RPM	7182	3591	2394	1795	1436	1197	898
					(188-282)	Fz	0.0002	0.0006	0.0010	0.0014	0.0017	0.0018	0.0019
					Feed (ipm)	7.5	10.8	12.0	12.6	12.2	10.8	8.5	
		HSM	≤ 0.05	≤ 2	355	RPM	10849	5424	3616	2712	2170	1808	1356
					(284-426)	Fz	0.0004	0.0011	0.0021	0.0028	0.0034	0.0036	0.0039
					Feed (ipm)	22.2	29.8	38.0	38.0	36.9	32.5	26.4	
S SUPER ALLOYS (NICKEL, COBALT, IRON BASE) Inconel 601, 617, 625, Incoloy, Monel 400	≤ 300 Bhn or ≤ 32 HRc	Profile	≤ 0.25	≤ 1.5	70	RPM	2139	1070	713	535	428	357	267
					(56-84)	Fz	0.0002	0.0006	0.0010	0.0014	0.0017	0.0018	0.0019
					Feed (ipm)	2.2	3.2	3.6	3.7	3.6	3.2	2.5	
		HSM	≤ 0.05	≤ 2	107	RPM	3270	1635	1090	817	654	545	409
					(86-128)	Fz	0.0004	0.0011	0.0021	0.0028	0.0034	0.0036	0.0039
					Feed (ipm)	6.7	9.0	11.4	11.4	11.1	9.8	8.0	
	≤ 400 Bhn or ≤ 43 HRc	Profile	≤ 0.25	≤ 1.5	55	RPM	1681	840	560	420	336	280	210
					(44-66)	Fz	0.0002	0.0004	0.0008	0.0010	0.0013	0.0014	0.0015
					Feed (ipm)	1.3	1.7	2.2	2.1	2.2	2.0	1.6	
		HSM	≤ 0.05	≤ 2	85	RPM	2598	1299	866	649	520	433	325
					(68-102)	Fz	0.0003	0.0008	0.0015	0.0021	0.0026	0.0027	0.0029
					Feed (ipm)	4.0	5.2	6.5	6.8	6.8	5.8	4.7	
TITANIUM ALLOYS Pure Titanium, Ti6Al4V, Ti6Al2Sn4Zr2Mo, Ti4Al4Mo2Sn0.5Si	≤ 350 Bhn or ≤ 38 HRc	Profile	≤ 0.25	≤ 1.5	235	RPM	7182	3591	2394	1795	1436	1197	898
					(188-282)	Fz	0.0002	0.0006	0.0012	0.0016	0.0020	0.0021	0.0023
					Feed (ipm)	7.2	10.8	14.4	14.4	14.4	12.6	10.3	
		HSM	≤ 0.05	≤ 2	390	RPM	11918	5959	3973	2980	2384	1986	1490
					(312-468)	Fz	0.0005	0.0013	0.0024	0.0032	0.0040	0.0041	0.0045
					Feed (ipm)	29.8	38.7	47.7	47.7	47.7	40.7	33.5	
	≤ 440 Bhn or ≤ 47 HRc	Profile	≤ 0.25	≤ 1.5	85	RPM	2598	1299	866	649	520	433	325
					(68-102)	Fz	0.0002	0.0006	0.0012	0.0016	0.0020	0.0021	0.0023
					Feed (ipm)	2.6	3.9	5.2	5.2	5.2	4.5	3.7	
		HSM	≤ 0.05	≤ 2	140	RPM	4278	2139	1426	1070	856	713	535
					(112-168)	Fz	0.0005	0.0013	0.0024	0.0032	0.0040	0.0042	0.0045
					Feed (ipm)	10.7	13.9	17.1	17.1	17.1	15.0	12.0	

Bhn (Brinell) HRc (Rockwell C) HSM (High Speed Machining)
 $rpm = Vc \times 3.82 / D_1$
 $ipm = Fz \times 5 \times rpm$
 reduce speed and feed for materials harder than listed
 reduce feed and Ae when finish milling (.02 x D₁ maximum)
 reduce Ap to 1 x D₁ (maximum) when profile milling with long or extra long flute length tools
 refer to the KYOCERA SGS Tool Wizard® for complete technical information (www.kyocera-sgstool.com)

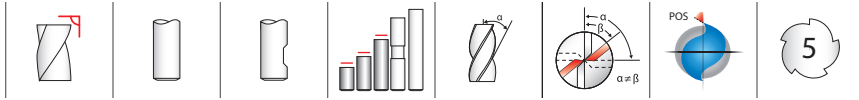

55M
METRIC SERIES

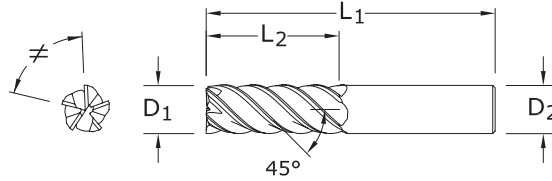

- Unequal indexing, high helix and an ideal rake and relief combination for unmatched finishing capability
- The choice when peak finish quality is the requirement
- Recommended for materials ≤ 45 HRc (≤ 420 Bhn)

CUTTING DIAMETER D_1	LENGTH OF CUT L_2	OVERALL LENGTH L_1	SHANK DIAMETER D_2	EDP NO.	
				Ti-NAMITE-A (AlTiN)	Ti-NAMITE-A (AlTiN) W/FLAT
6,0	12,0	50,0	6,0	42606	—
6,0	19,0	63,0	6,0	42607	—
6,0	25,0	75,0	6,0	42608	—
8,0	12,0	50,0	8,0	42609	—
8,0	20,0	63,0	8,0	42610	—
8,0	25,0	75,0	8,0	42611	—
10,0	16,0	50,0	10,0	42612	—
10,0	22,0	75,0	10,0	42622	42613
10,0	38,0	100,0	10,0	42614	—
12,0	19,0	63,0	12,0	42615	—
12,0	25,0	75,0	12,0	42616	42623
12,0	50,0	100,0	12,0	42617	—
16,0	32,0	89,0	16,0	42618	42624
16,0	50,0	100,0	16,0	42626	—
16,0	75,0	150,0	16,0	42619	—
20,0	38,0	100,0	20,0	42620	42625
20,0	50,0	100,0	20,0	42627	—
20,0	75,0	150,0	20,0	42621	—

TOLERANCES (mm)

$D_1 = +0,000/-0,050$
 $D_2 = h_6$

- STEELS
- STAINLESS STEELS
- CAST IRON
- HIGH TEMP ALLOYS
- TITANIUM
- HARDENED STEELS

For patent information visit www.ksptpatents.com

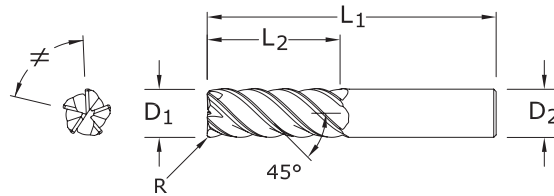

TOLERANCES (mm)

$D_1 = +0,000/-0,050$

$D_2 = h_6$

$R = +0,000/-0,050$

- STEELS
- STAINLESS STEELS
- CAST IRON
- HIGH TEMP ALLOYS
- TITANIUM
- HARDENED STEELS

For patent information visit www.ksptpatents.com

55MCR
METRIC SERIES

mm					EDP NO.
CUTTING DIAMETER D_1	LENGTH OF CUT L_2	OVERALL LENGTH L_1	SHANK DIAMETER D_2	CORNER RADIUS R	Ti-NAMITE-A (AITiN)
6,0	12,0	50,0	6,0	0,5	42660
6,0	19,0	63,0	6,0	0,25	42661
6,0	19,0	63,0	6,0	0,5	42662
6,0	19,0	63,0	6,0	1,0	42663
6,0	19,0	63,0	6,0	1,5	42664
6,0	25,0	75,0	6,0	0,5	42665
8,0	12,0	50,0	8,0	0,5	42666
8,0	20,0	63,0	8,0	0,5	42667
8,0	20,0	63,0	8,0	1,0	42668
8,0	20,0	63,0	8,0	1,5	42669
8,0	20,0	63,0	8,0	2,0	42670
8,0	25,0	75,0	8,0	0,5	42671
10,0	16,0	50,0	10,0	0,5	42672
10,0	22,0	75,0	10,0	0,5	42673
10,0	22,0	75,0	10,0	1,0	42674
10,0	22,0	75,0	10,0	1,5	42675
10,0	22,0	75,0	10,0	2,0	42676
10,0	22,0	75,0	10,0	2,5	42677
10,0	38,0	100,0	10,0	0,5	42678
12,0	19,0	63,0	12,0	0,5	42679
12,0	25,0	75,0	12,0	0,5	42680
12,0	25,0	75,0	12,0	1,0	42681
12,0	25,0	75,0	12,0	1,5	42682
12,0	25,0	75,0	12,0	2,0	42683
12,0	25,0	75,0	12,0	2,5	42684
12,0	25,0	75,0	12,0	3,0	42685
12,0	50,0	100,0	12,0	0,5	42686
12,0	50,0	100,0	12,0	3,0	42630
12,0	50,0	100,0	12,0	4,0	42631
16,0	32,0	89,0	16,0	1,0	42687
16,0	32,0	89,0	16,0	1,5	42688
16,0	32,0	89,0	16,0	2,0	42689

- Unequal indexing, high helix and an ideal rake and relief combination for unmatched finishing capability
- The choice when peak finish quality is the requirement
- Recommended for materials ≤ 45 HRC (≤ 420 Bhn)

continued on next page

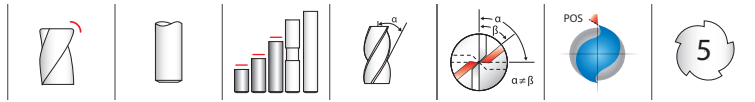

55MCR
METRIC SERIES

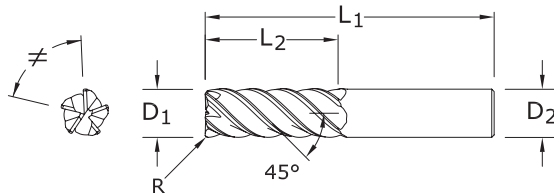

CONTINUED

CUTTING DIAMETER D ₁	LENGTH OF CUT L ₂	mm			EDP NO.
		OVERALL LENGTH L ₁	SHANK DIAMETER D ₂	CORNER RADIUS R	Ti-NAMITE-A (AlTiN)
16,0	32,0	89,0	16,0	2,5	42690
16,0	32,0	89,0	16,0	3,0	42691
16,0	32,0	89,0	16,0	4,0	42692
16,0	50,0	100,0	16,0	2,0	42656
16,0	50,0	100,0	16,0	2,5	42657
16,0	50,0	100,0	16,0	3,0	42658
16,0	50,0	100,0	16,0	4,0	42659
16,0	50,0	100,0	16,0	5,0	42628
16,0	75,0	150,0	16,0	1,0	42693
16,0	75,0	150,0	16,0	3,0	42632
16,0	75,0	150,0	16,0	4,0	42633
20,0	38,0	100,0	20,0	1,0	42694
20,0	38,0	100,0	20,0	1,5	42695
20,0	38,0	100,0	20,0	2,0	42696
20,0	38,0	100,0	20,0	2,5	42697
20,0	38,0	100,0	20,0	3,0	42698
20,0	38,0	100,0	20,0	4,0	42699
20,0	38,0	100,0	20,0	5,0	42700
20,0	38,0	100,0	20,0	6,0	42648
20,0	50,0	100,0	20,0	2,0	42649
20,0	50,0	100,0	20,0	2,5	42650
20,0	50,0	100,0	20,0	3,0	42651
20,0	50,0	100,0	20,0	4,0	42652
20,0	50,0	100,0	20,0	5,0	42653
20,0	50,0	100,0	20,0	6,0	42654
20,0	75,0	150,0	20,0	1,0	42701
20,0	75,0	150,0	20,0	2,0	42702
20,0	75,0	150,0	20,0	3,0	42703
20,0	75,0	150,0	20,0	4,0	42704
20,0	75,0	150,0	20,0	5,0	42705
20,0	75,0	150,0	20,0	6,0	42655

TOLERANCES (mm)

D₁ = +0,000/-0,050

D₂ = h₆

R = +0,000/-0,050

- STEELS
- STAINLESS STEELS
- CAST IRON
- HIGH TEMP ALLOYS
- TITANIUM
- HARDENED STEELS

For patent information visit www.ksptpatents.com

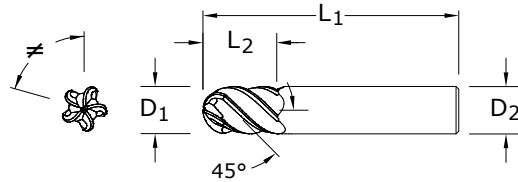

55MB
METRIC SERIES

TOLERANCES (mm)

$D_1 = +0,000/-0,050$

$D_2 = h_6$

BALL RADIUS

$+0,000/-0,025$

- STEELS
- STAINLESS STEELS
- CAST IRON
- HIGH TEMP ALLOYS
- TITANIUM
- HARDENED STEELS

mm				EDP NO.
CUTTING DIAMETER D_1	LENGTH OF CUT L_2	OVERALL LENGTH L_1	SHANK DIAMETER D_2	Ti-NAMITE-A (AlTiN)
6,0	13,0	57,0	6,0	42750
8,0	19,0	63,0	8,0	42751
10,0	22,0	72,0	10,0	42752
12,0	26,0	83,0	12,0	42753
16,0	32,0	92,0	16,0	42754
20,0	38,0	104,0	20,0	42755

- Unequal indexing, high helix and an ideal rake and relief combination for unmatched finishing capability
- The choice when peak finish quality is the requirement
- Ball nose design ideal for finishing operations in complex workpieces
- Recommended for materials ≤ 45 HRc (≤ 420 Bhn)

For patent information visit www.ksptpatents.com

METRIC V-Carb

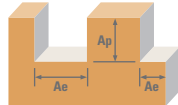

Series
55M, 55MCR,
55MB
Metric

Metric	Hardness	Ae x D ₁	Ap x D ₁	Vc (m/min)	Diameter (D ₁) (mm)							
					6	8	10	12	16	20		
P	CARBON STEELS 1018, 1040, 1080, 1090, 10L50, 1140, 1212, 12L15, 1525, 1536	Profile 	≤ 0.25	≤ 1.5	117	RPM	6220	4665	3732	3110	2333	1866
					(94-141)	Fz	0.022	0.036	0.061	0.070	0.072	0.085
					Feed (mm/min)	672	846	1145	1082	836	796	
		HSM 	≤ 0.05	≤ 2	192	RPM	10179	7634	6107	5089	3817	3054
					(154-230)	Fz	0.043	0.073	0.123	0.137	0.141	0.154
					Feed (mm/min)	2198	2769	3746	3481	2687	2345	
	ALLOY STEELS 4140, 4150, 4320, 5120, 5150, 8630, 86L20, 50100	Profile 	≤ 0.25	≤ 1.5	99	RPM	5251	3938	3151	2626	1969	1575
					(79-119)	Fz	0.017	0.028	0.045	0.053	0.054	0.064
					Feed (mm/min)	441	546	571	693	529	504	
		HSM 	≤ 0.05	≤ 2	162	RPM	8563	6422	5138	4282	3211	2569
					(129-194)	Fz	0.034	0.055	0.091	0.103	0.105	0.128
					Feed (mm/min)	1438	1781	2329	2209	1685	1644	
H	TOOL STEELS A2, D2, H13, L2, M2, P20, S7, T15, W2	Profile 	≤ 0.25	≤ 1.5	53	RPM	2827	2121	1696	1414	1060	848
					(43-64)	Fz	0.012	0.021	0.035	0.038	0.044	0.048
					Feed (mm/min)	170	226	294	271	231	204	
		HSM 	≤ 0.05	≤ 2	88	RPM	4686	3514	2811	2343	1757	1406
					(71-106)	Fz	0.024	0.041	0.067	0.077	0.084	0.093
					Feed (mm/min)	562	712	937	900	742	656	
K	CAST IRONS (LOW & MEDIUM ALLOY) Gray, Malleable, Ductile	Profile 	≤ 0.25	≤ 1.5	143	RPM	7594	5695	4556	3797	2848	2278
					(115-172)	Fz	0.022	0.036	0.061	0.070	0.077	0.085
					Feed (mm/min)	820	1033	1397	1321	1093	972	
		HSM 	≤ 0.05	≤ 2	215	RPM	11391	8543	6834	5695	4271	3417
					(172-258)	Fz	0.043	0.073	0.123	0.137	0.151	0.171
					Feed (mm/min)	2460	3099	4192	3895	3226	2916	
	CAST IRONS (HIGH ALLOY) Gray, Malleable, Ductile	Profile 	≤ 0.25	≤ 1.5	110	RPM	5816	4362	3490	2908	2181	1745
					(88-132)	Fz	0.017	0.028	0.045	0.053	0.059	0.064
					Feed (mm/min)	489	605	791	768	642	558	
		HSM 	≤ 0.05	≤ 2	165	RPM	8725	6544	5235	4362	3272	2617
					(132-198)	Fz	0.034	0.055	0.091	0.103	0.113	0.128
					Feed (mm/min)	1466	1815	2373	2251	1843	1675	

continued on next page

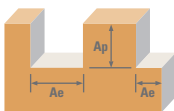

Series	Hardness	Ae x D ₁	Ap x D ₁	Vc (m/min)	Diameter (D ₁) (mm)						
					6	8	10	12	16	20	
M STAINLESS STEELS (FREE MACHINING) 303, 416, 420F, 430F, 440F	≤ 275 Bhn or ≤ 28 HRc	Profile ≤ 0.25	≤ 1.5	113	RPM	5978	4484	3587	2989	2242	1793
				(90-135)	Fz	0.017	0.028	0.045	0.053	0.059	0.064
				Feed (mm/min)	502	622	813	789	660	574	
		HSM ≤ 0.05	≤ 2	171	RPM	9048	6786	5429	4524	3393	2714
				(137-205)	Fz	0.034	0.055	0.091	0.103	0.113	0.128
				Feed (mm/min)	1520	1882	2461	2334	1911	1737	
M STAINLESS STEELS (DIFFICULT) 304, 304L, 316, 316L	≤ 275 Bhn or ≤ 28 HRc	Profile ≤ 0.25	≤ 1.5	78	RPM	4120	3090	2472	2060	1545	1236
				(62-93)	Fz	0.014	0.026	0.043	0.048	0.054	0.061
				Feed (mm/min)	297	396	527	494	415	379	
		HSM ≤ 0.05	≤ 2	117	RPM	6220	4665	3732	3110	2333	1866
				(94-141)	Fz	0.031	0.051	0.085	0.096	0.105	0.120
				Feed (mm/min)	970	1194	1592	1493	1224	1120	
M STAINLESS STEELS (PH) 13-8 PH, 15-5 PH, 17-4 PH, Custom 450	≤ 325 Bhn or ≤ 35 HRc	Profile ≤ 0.25	≤ 1.5	72	RPM	3797	2848	2278	1898	1424	1139
				(57-86)	Fz	0.014	0.021	0.037	0.041	0.046	0.051
				Feed (mm/min)	273	13260	425	387	328	289	
		HSM ≤ 0.05	≤ 2	108	RPM	5736	4302	3441	2868	2151	1721
				(87-130)	Fz	0.026	0.045	0.075	0.082	0.092	0.104
				Feed (mm/min)	757	14850	1285	1170	991	895	
S SUPER ALLOYS (NICKEL, COBALT, IRON BASE) Inconel 601, 617, 625, Incoloy, Monel 400	≤ 300 Bhn or ≤ 32 HRc	Profile ≤ 0.25	≤ 1.5	21	RPM	1131	848	679	565	424	339
				(17-26)	Fz	0.014	0.021	0.037	0.041	0.046	0.051
				Feed (mm/min)	81	16530	196792	115	98	86	
		HSM ≤ 0.05	≤ 2	33	RPM	1729	1297	1037	864	648	519
				(26-39)	Fz	0.026	0.045	0.075	0.082	0.092	0.104
				Feed (mm/min)	228	290	387	353	299	270	
S SUPER ALLOYS (NICKEL, COBALT, IRON BASE) Inconel 718, X-750, Incoloy, Waspaloy, Hastelloy, Rene	≤ 400 Bhn or ≤ 43 HRc	Profile ≤ 0.25	≤ 1.5	17	RPM	889	666	533	444	333	267
				(13-20)	Fz	0.010	0.017	0.027	0.031	0.036	0.040
				Feed (mm/min)	43	57	71	69	60	53	
		HSM ≤ 0.05	≤ 2	26	RPM	1373	1030	824	687	515	412
				(21-31)	Fz	0.019	0.032	0.056	0.062	0.069	0.077
				Feed (mm/min)	132	165	231	214	178	159	

continued on next page

METRIC V-Carb

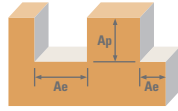

Series 55M, 55MCR, 55MB Metric	Hardness	Ae x D ₁	Ap x D ₁	Vc (m/min)	Diameter (D ₁) (mm)							
					6	8	10	12	16	20		
S	TITANIUM ALLOYS Pure Titanium, Ti6Al4V, Ti6Al2Sn4Zr2Mo, Ti4Al4Mo2Sn0.5Si ≤ 350 Bhn or ≤ 38 HRc	Profile 	≤ 0.25	≤ 1.5	72	RPM	3797	2848	2278	1898	1424	1139
					(57-86)	Fz	0.014	0.026	0.043	0.048	0.054	0.061
					Feed (mm/min)	273	365	486	456	383	349	
		HSM 	≤ 0.05	≤ 2	119	RPM	6301	4726	3781	3151	2363	1890
					(95-143)	Fz	0.031	0.051	0.085	0.096	0.105	0.120
					Feed (mm/min)	983	1210	1613	1512	1240	1134	
	TITANIUM ALLOYS (DIFFICULT) Ti10Al2Fe3Al, Ti5Al5V5Mo3Cr, Ti7Al4Mo, Ti3Al8V6Cr4Zr4Mo, Ti6Al6V6Sn, Ti15V3 Cr3Sn3Al ≤ 440 Bhn or ≤ 47 HRc	Profile 	≤ 0.25	≤ 1.5	26	RPM	1373	1030	824	687	515	412
					(21-31)	Fz	0.014	0.026	0.043	0.048	0.054	0.061
					Feed (mm/min)	99	132	176	165	138	126	
		HSM 	≤ 0.05	≤ 2	43	RPM	2262	1696	1357	1131	848	679
					(34-51)	Fz	0.031	0.051	0.085	0.096	0.108	0.120
					Feed (mm/min)	353	434	579	543	456	407	

Bhn (Brinell) HRc (Rockwell C) HSM (High Speed Machining)

rpm = (Vc x 1000) / (D₁ x 3.14)

mm/min = Fz x 5 x rpm

reduce speed and feed for materials harder than listed

reduce feed and Ae when finish milling (.02 x D₁ maximum)

reduce Ap to 1 x D₁ (maximum) when profile milling with long or extra long flute length tools

refer to the KYOCERA SGS Tool Wizard® for complete technical information (www.kyocera-sgstool.com)

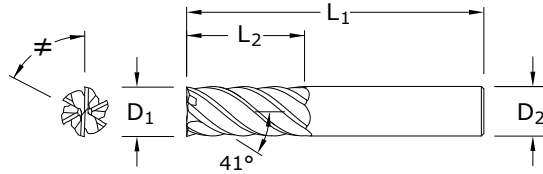
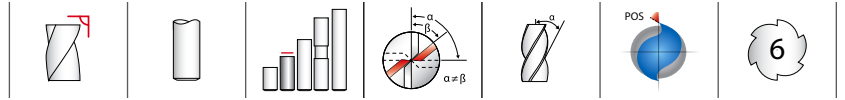
TOLERANCES (inch)
 $D_1 = +0.0000/-0.0020$
 $D_2 = h6$

- STEELS**
- STAINLESS STEELS**
- HIGH TEMP ALLOYS**
- TITANIUM**
- HARDENED STEELS**

For patent information visit www.ksptpatents.com

51

FRACTIONAL SERIES

inch				EDP NO.
CUTTING DIAMETER D_1	LENGTH OF CUT L_2	OVERALL LENGTH L_1	SHANK DIAMETER D_2	TI-NAMITE-X (TX)
1/4	3/4	2-1/2	1/4	35100
3/8	1	2-1/2	3/8	35101
1/2	1-1/4	3	1/2	35102
5/8	1-5/8	3-1/2	5/8	35103
3/4	1-5/8	4	3/4	35104
1	2-5/8	6	1	35105

- Engineered for High Speed Milling using Trochoidal and Peel Milling techniques
- Eccentric relief provides superior strength and smoother surface finish
- Recommended for materials ≤ 45 HRc (≤ 420 Bhn)

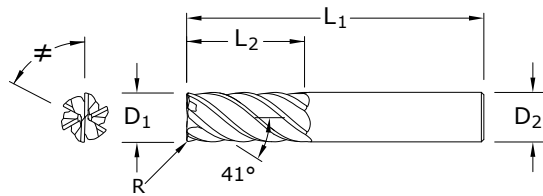
TOLERANCES (inch)
 $D_1 = +0.0000/-0.0020$
 $D_2 = h6$
 $R = +0.0000/-0.0020$

- STEELS**
- STAINLESS STEELS**
- HIGH TEMP ALLOYS**
- TITANIUM**
- HARDENED STEELS**

For patent information visit www.ksptpatents.com

51CR

FRACTIONAL SERIES

inch					EDP NO.
CUTTING DIAMETER D_1	LENGTH OF CUT L_2	OVERALL LENGTH L_1	SHANK DIAMETER D_2	CORNER RADIUS R	TI-NAMITE-X (TX)
1/4	3/4	2-1/2	1/4	.015	35112
1/4	3/4	2-1/2	1/4	.030	35150
3/8	1	2-1/2	3/8	.015	35113
3/8	1	2-1/2	3/8	.030	35114
1/2	1-1/4	3	1/2	.015	35151
1/2	1-1/4	3	1/2	.030	35115
1/2	1-1/4	3	1/2	.060	35152
1/2	1-1/4	3	1/2	.090	35116
1/2	1-1/4	3	1/2	.120	35117
5/8	1-5/8	3-1/2	5/8	.015	35153
5/8	1-5/8	3-1/2	5/8	.030	35118
5/8	1-5/8	3-1/2	5/8	.060	35154
5/8	1-5/8	3-1/2	5/8	.090	35119
5/8	1-5/8	3-1/2	5/8	.120	35120
5/8	1-5/8	3-1/2	5/8	.190	35155
3/4	1-5/8	4	3/4	.030	35121
3/4	1-5/8	4	3/4	.060	35156
3/4	1-5/8	4	3/4	.090	35122
3/4	1-5/8	4	3/4	.120	35123
3/4	1-5/8	4	3/4	.190	35157
3/4	1-5/8	4	3/4	.250	35158
1	2-5/8	6	1	.030	35124
1	2-5/8	6	1	.060	35159
1	2-5/8	6	1	.090	35125
1	2-5/8	6	1	.120	35126
1	2-5/8	6	1	.190	35160
1	2-5/8	6	1	.250	35161

- Engineered for High Speed Milling using Trochoidal and Peel Milling techniques
- Eccentric relief provides superior strength and smoother surface finish
- Enhanced corner geometry with tight tolerance corner radii
- Recommended for materials ≤ 45 HRc (≤ 420 Bhn)

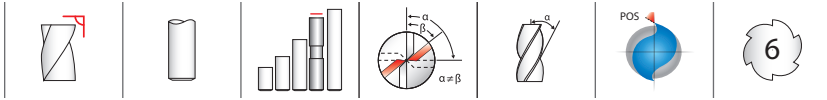

51L
FRACTIONAL SERIES

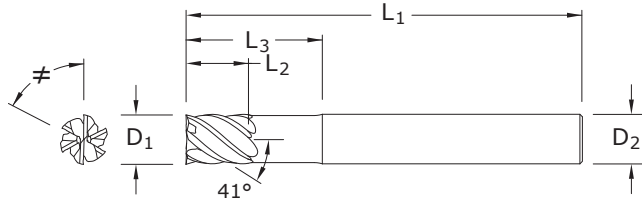

- Engineered for High Speed Milling using Trochoidal and Peel Milling techniques
- Eccentric relief provides superior strength and smoother surface finish
- Necked design with blended diameter transitions provide clearance to reach
- Recommended for materials ≤ 45 HRC (≤ 420 Bhn)

CUTTING DIAMETER D_1	LENGTH OF CUT L_2	inch			REACH L_3	EDP NO. TI-NAMITE-X (TX)
		OVERALL LENGTH L_1	SHANK DIAMETER D_2			
1/4	3/8	4	1/4	1-1/8	35106	
3/8	1/2	4	3/8	2-1/8	35107	
1/2	5/8	4	1/2	2-1/4	35108	
5/8	3/4	5	5/8	2-1/2	35109	
3/4	1	6	3/4	3-3/8	35110	
1	1-1/4	6	1	3-3/8	35111	

TOLERANCES (inch)

$D_1 = +0.0000/-0.0020$
 $D_2 = h6$

- STEELS
- STAINLESS STEELS
- HIGH TEMP ALLOYS
- TITANIUM
- HARDENED STEELS

For patent information visit
www.ksptpatents.com

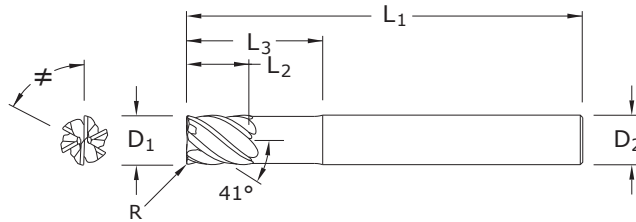
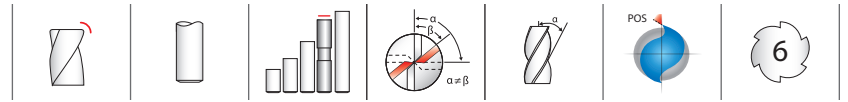

51LC
FRACTIONAL SERIES

TOLERANCES (inch)
 $D_1 = +0.0000/-0.0020$
 $D_2 = h6$
 $R = +0.0000/-0.0020$

- STEELS
- STAINLESS STEELS
- HIGH TEMP ALLOYS
- TITANIUM
- HARDENED STEELS

For patent information visit www.ksptpatents.com

inch						EDP NO.
CUTTING DIAMETER D_1	LENGTH OF CUT L_2	OVERALL LENGTH L_1	SHANK DIAMETER D_2	REACH L_3	CORNER RADIUS R	TI-NAMITE-X (TX)
1/4	3/8	4	1/4	1-1/8	.015	35127
1/4	3/8	4	1/4	1-1/8	.030	35180
3/8	1/2	4	3/8	2-1/8	.015	35128
3/8	1/2	4	3/8	2-1/8	.030	35129
1/2	5/8	4	1/2	2-1/4	.015	35181
1/2	5/8	4	1/2	2-1/4	.030	35130
1/2	5/8	4	1/2	2-1/4	.060	35182
1/2	5/8	4	1/2	2-1/4	.090	35131
1/2	5/8	4	1/2	2-1/4	.120	35132
5/8	3/4	5	5/8	2-1/2	.015	35183
5/8	3/4	5	5/8	2-1/2	.030	35133
5/8	3/4	5	5/8	2-1/2	.060	35184
5/8	3/4	5	5/8	2-1/2	.090	35134
5/8	3/4	5	5/8	2-1/2	.120	35135
5/8	3/4	5	5/8	2-1/2	.190	35185
3/4	1	6	3/4	3-3/8	.030	35136
3/4	1	6	3/4	3-3/8	.060	35186
3/4	1	6	3/4	3-3/8	.090	35137
3/4	1	6	3/4	3-3/8	.120	35138
3/4	1	6	3/4	3-3/8	.190	35187
3/4	1	6	3/4	3-3/8	.250	35188
1	1-1/4	6	1	3-3/8	.030	35139
1	1-1/4	6	1	3-3/8	.060	35189
1	1-1/4	6	1	3-3/8	.090	35140
1	1-1/4	6	1	3-3/8	.120	35141
1	1-1/4	6	1	3-3/8	.190	35190
1	1-1/4	6	1	3-3/8	.250	35191

- Engineered for High Speed Milling using Trochoidal and Peel Milling techniques
- Eccentric relief provides superior strength and smoother surface finish
- Necked design with blended diameter transitions provide clearance to reach
- Enhanced corner geometry with tight tolerance corner radii
- Recommended for materials ≤ 45 HRC (≤ 420 Bhn)

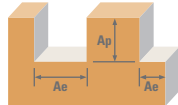

Series
51, 51CR, 51L,
51LC

Fractional	Hardness	Ae x D ₁	Ap x D ₁	Vc (sfm)	Diameter (D ₁) (inch)							
					1/4	3/8	1/2	5/8	3/4	1		
P	CARBON STEELS 1018, 1040, 1080, 1090, 10L50, 1140, 1212, 12L15, 1525, 1536	Profile 	≤ 0.1	≤ 1	720	RPM	11002	7334	5501	4401	3667	2750
					(576-864)	Fz	0.0020	0.0035	0.0050	0.0055	0.0061	0.0071
					Feed (ipm)	132	154	165	145	134	117	
		HSM 	≤ 0.05	≤ 2	915	RPM	13981	9321	6991	5592	4660	3495
					(732-1098)	Fz	0.0028	0.0053	0.0070	0.0077	0.0085	0.0100
					Feed (ipm)	235	296	294	258	238	210	
	ALLOY STEELS 4140, 4150, 4320, 5120, 5150, 8630, 86L20, 50100	Profile 	≤ 0.1	≤ 1	490	RPM	7487	4991	3744	2995	2496	1872
					(392-588)	Fz	0.0015	0.0029	0.0038	0.0042	0.0046	0.0054
					Feed (ipm)	67	87	85	75	69	61	
		HSM 	≤ 0.05	≤ 2	620	RPM	9474	6316	4737	3789	3158	2368
					(496-744)	Fz	0.0021	0.0039	0.0052	0.0057	0.0062	0.0073
					Feed (ipm)	119	148	148	130	117	104	
H	TOOL STEELS A2, D2, H13, L2, M2, P20, S7, T15, W2	Profile 	≤ 0.1	≤ 1	240	RPM	3667	2445	1834	1467	1222	917
					(192-288)	Fz	0.0012	0.0023	0.0030	0.0034	0.0037	0.0043
					Feed (ipm)	26	34	33	30	27	24	
	HSM 	≤ 0.05	≤ 2	305	RPM	4660	3107	2330	1864	1553	1165	
				(244-366)	Fz	0.0017	0.0032	0.0042	0.0046	0.0050	0.0059	
				Feed (ipm)	48	60	59	51	47	41		
M	STAINLESS STEELS (FREE MACHINING) 303, 416, 420F, 430F, 440F	Profile 	≤ 0.1	≤ 1	510	RPM	7793	5195	3896	3117	2598	1948
					(459-561)	Fz	0.0015	0.0028	0.0038	0.0041	0.0045	0.0053
					Feed (ipm)	70	87	89	77	70	62	
		HSM 	≤ 0.05	≤ 2	650	RPM	9932	6621	4966	3973	3311	2483
					(585-715)	Fz	0.0021	0.0038	0.0051	0.0056	0.0061	0.0072
					Feed (ipm)	125	151	152	133	121	107	
	STAINLESS STEELS (DIFFICULT) 304, 304L, 316, 316L	Profile 	≤ 0.1	≤ 1	350	RPM	5348	3565	2674	2139	1783	1337
					(315-385)	Fz	0.0012	0.0023	0.0030	0.0033	0.0036	0.0042
					Feed (ipm)	39	49	48	42	39	34	
		HSM 	≤ 0.05	≤ 2	450	RPM	6876	4584	3438	2750	2292	1719
					(405-495)	Fz	0.0017	0.0032	0.0042	0.0046	0.0050	0.0059
					Feed (ipm)	70	88	87	76	69	61	
STAINLESS STEELS (PH) 13-8 PH, 15-5 PH, 17-4 PH, Custom 450	Profile 	≤ 0.1	≤ 1	325	RPM	4966	3311	2483	1986	1655	1242	
				(293-358)	Fz	0.0012	0.0023	0.0030	0.0033	0.0036	0.0042	
				Feed (ipm)	36	46	45	39	36	31		
	HSM 	≤ 0.05	≤ 2	410	RPM	6265	4177	3132	2506	2088	1566	
				(369-451)	Fz	0.0017	0.0032	0.0042	0.0046	0.0050	0.0059	
				Feed (ipm)	64	80	79	69	63	55		

continued on next page

Series 51, 51CR, 51L, 51LC Fractional	Hardness			Vc (sfm)	Diameter (D ₁) (inch)							
		Ae x D ₁	Ap x D ₁		1/4	3/8	1/2	5/8	3/4	1		
SUPER ALLOYS (NICKEL, COBALT, IRON BASE) Inconel 601, 617, 625, Incoloy, Monel 400	≤ 300 Bhn or ≤ 32 HRc	Profile 	≤ 0.1	≤ 1	105	RPM	1604	1070	802	642	535	401
					(84-126)	Fz	0.0014	0.0027	0.0036	0.0039	0.0043	0.0050
					Feed (ipm)	13	17	17	15	14	12	
		HSM 	≤ 0.05	≤ 2	130	RPM	1986	1324	993	795	662	497
					(104-156)	Fz	0.0016	0.0036	0.0048	0.0053	0.0058	0.0067
					Feed (ipm)	19	29	29	25	23	20	
SUPER ALLOYS (NICKEL, COBALT, IRON BASE) Inconel 718, X-750, Incoloy, Waspaloy, Hastelloy, Rene	≤ 400 Bhn or ≤ 43 HRc	Profile 	≤ 0.1	≤ 1	80	RPM	1222	815	611	489	407	306
					(64-96)	Fz	0.0010	0.0018	0.0025	0.0027	0.0029	0.0034
					Feed (ipm)	7	9	9	8	7	6	
		HSM 	≤ 0.05	≤ 2	100	RPM	1528	1019	764	611	509	382
					(80-120)	Fz	0.0013	0.0025	0.0034	0.0037	0.0041	0.0047
					Feed (ipm)	12	15	16	14	13	11	
TITANIUM ALLOYS Pure Titanium, Ti6Al4V, Ti6Al2Sn4Zr2Mo, Ti4Al4Mo2Sn0.5Si	≤ 350 Bhn or ≤ 38 HRc	Profile 	≤ 0.1	≤ 1	280	RPM	4278	2852	2139	1711	1426	1070
					(224-336)	Fz	0.0010	0.0018	0.0025	0.0027	0.0029	0.0034
					Feed (ipm)	26	31	32	28	25	22	
		HSM 	≤ 0.05	≤ 2	355	RPM	5424	3616	2712	2170	1808	1356
					(284-426)	Fz	0.0013	0.0025	0.0034	0.0037	0.0041	0.0047
					Feed (ipm)	42	54	55	48	44	38	
TITANIUM ALLOYS (DIFFICULT) Ti10Al2Fe3Al, Ti5Al5V5Mo3Cr, Ti7Al4Mo, Ti3Al8V6Cr4Zr4Mo, Ti6Al6V6Sn, Ti15V3 Cr3Sn3Al	≤ 440 Bhn or ≤ 47 HRc	Profile 	≤ 0.1	≤ 1	155	RPM	2368	1579	1184	947	789	592
					(124-186)	Fz	0.0010	0.0018	0.0025	0.0027	0.0029	0.0034
					Feed (ipm)	14	17	18	15	14	12	
		HSM 	≤ 0.05	≤ 2	200	RPM	3056	2037	1528	1222	1019	764
					(160-240)	Fz	0.0013	0.0025	0.0034	0.0037	0.0041	0.0047
					Feed (ipm)	24	31	31	27	25	22	

Bhn (Brinell) HRc (Rockwell C) HSM (High Speed Machining)
 rpm = Vc x 3.82 / D₁
 ipm = Fz x 6 x rpm
 reduce speed and feed for materials harder than listed
 reduce feed and Ae when finish milling (.02 x D₁ maximum)
 refer to the KYOCERA SGS Tool Wizard® for complete technical information (www.kyocera-sgstool.com)

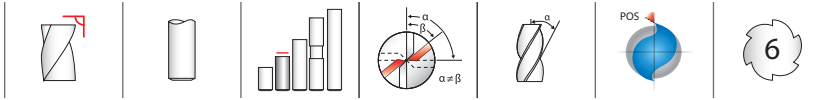

51M
METRIC SERIES

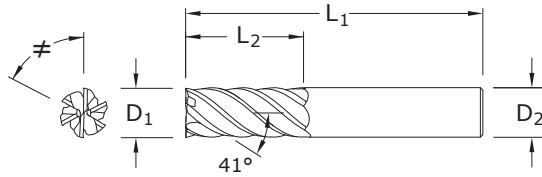

- Engineered for High Speed Milling using Trochoidal and Peel Milling techniques
- Eccentric relief provides superior strength and smoother surface finish
- Recommended for materials ≤ 45 HRc (≤ 420 Bhn)

	mm			EDP NO.	
CUTTING DIAMETER D_1	LENGTH OF CUT L_2	OVERALL LENGTH L_1	SHANK DIAMETER D_2	TI-NAMITE-X (TX)	
6,0	19,0	63,0	6,0	45100	
8,0	20,0	63,0	8,0	45101	
10,0	22,0	75,0	10,0	45102	
12,0	26,0	83,0	12,0	45103	
16,0	32,0	92,0	16,0	45104	
20,0	38,0	104,0	20,0	45105	

TOLERANCES (mm)

$D_1 = +0,000/-0,050$
 $D_2 = h6$

- STEELS
- STAINLESS STEELS
- HIGH TEMP ALLOYS
- TITANIUM
- HARDENED STEELS

For patent information visit www.ksptpatents.com

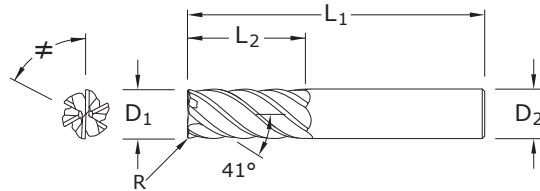
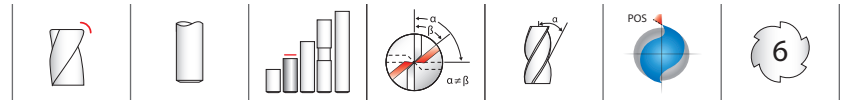

51MCR

METRIC SERIES

TOLERANCES (mm)

D₁ = +0,000/-0,050

D₂ = h6

R = +0,000/-0,050

- STEELS
- STAINLESS STEELS
- HIGH TEMP ALLOYS
- TITANIUM
- HARDENED STEELS

For patent information visit www.ksptpatents.com

CUTTING DIAMETER D ₁	LENGTH OF CUT L ₂	OVERALL LENGTH L ₁	SHANK DIAMETER D ₂	CORNER RADIUS R	EDP NO. TI-NAMITE-X (TX)
6,0	19,0	63,0	6,0	0,5	45112
6,0	19,0	63,0	6,0	1,0	45170
6,0	19,0	63,0	6,0	1,5	45171
8,0	20,0	63,0	8,0	0,5	45113
8,0	20,0	63,0	8,0	1,0	45114
8,0	20,0	63,0	8,0	1,2	45150
8,0	20,0	63,0	8,0	1,5	45172
8,0	20,0	63,0	8,0	2,0	45173
10,0	22,0	75,0	10,0	0,5	45174
10,0	22,0	75,0	10,0	1,0	45115
10,0	22,0	75,0	10,0	1,5	45116
10,0	22,0	75,0	10,0	2,0	45117
10,0	22,0	75,0	10,0	2,5	45175
12,0	26,0	83,0	12,0	0,5	45176
12,0	26,0	83,0	12,0	0,76	45177
12,0	26,0	83,0	12,0	1,0	45118
12,0	26,0	83,0	12,0	1,5	45119
12,0	26,0	83,0	12,0	2,0	45120
12,0	26,0	83,0	12,0	2,5	45178
12,0	26,0	83,0	12,0	3,0	45179
16,0	32,0	92,0	16,0	1,0	45121
16,0	32,0	92,0	16,0	1,5	45122
16,0	32,0	92,0	16,0	2,0	45123
16,0	32,0	92,0	16,0	2,5	45180
16,0	32,0	92,0	16,0	3,0	45181
16,0	32,0	92,0	16,0	4,0	45182
20,0	38,0	104,0	20,0	1,0	45124
20,0	38,0	104,0	20,0	1,5	45125
20,0	38,0	104,0	20,0	2,0	45126
20,0	38,0	104,0	20,0	2,5	45183
20,0	38,0	104,0	20,0	3,0	45184
20,0	38,0	104,0	20,0	4,0	45185
20,0	38,0	104,0	20,0	5,0	45186

- Engineered for High Speed Milling using Trochoidal and Peel Milling techniques
- Eccentric relief provides superior strength and smoother surface finish
- Enhanced corner geometry with tight tolerance corner radii
- Recommended for materials ≤ 45 HRC (≤ 420 Bhn)

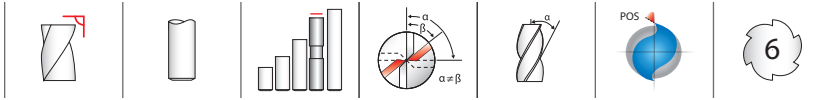

51ML
METRIC SERIES

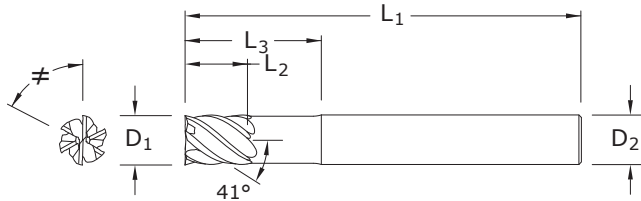

- Engineered for High Speed Milling using Trochoidal and Peel Milling techniques
- Eccentric relief provides superior strength and smoother surface finish
- Necked design with blended diameter transitions provide clearance to reach
- Recommended for materials ≤ 45 HRc (≤ 420 Bhn)

CUTTING DIAMETER D_1	LENGTH OF CUT L_2	mm			EDP NO.
		OVERALL LENGTH L_1	SHANK DIAMETER D_2	REACH L_3	
6,0	8,0	75,0	6,0	32,0	45106
8,0	10,0	75,0	8,0	32,0	45107
10,0	12,0	100,0	10,0	40,0	45108
12,0	15,0	100,0	12,0	48,0	45109
16,0	20,0	115,0	16,0	65,0	45110
20,0	24,0	150,0	20,0	80,0	45111

TOLERANCES (mm)

$D_1 = +0,000/-0,050$
 $D_2 = h6$

- STEELS
- STAINLESS STEELS
- HIGH TEMP ALLOYS
- TITANIUM
- HARDENED STEELS

For patent information visit www.ksptpatents.com

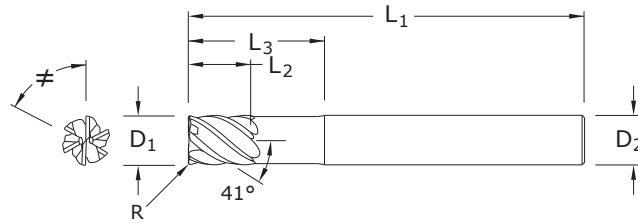
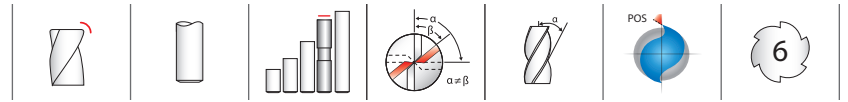

51MLC

METRIC SERIES

TOLERANCES (mm)
 $D_1 = +0,000/-0,050$
 $D_2 = h6$
 $R = +0,000/-0,050$

- STEELS
- STAINLESS STEELS
- HIGH TEMP ALLOYS
- TITANIUM
- HARDENED STEELS

For patent information visit www.ksptpatents.com





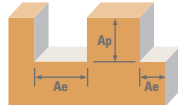

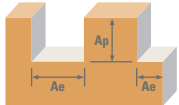

mm						EDP NO.
CUTTING DIAMETER D_1	LENGTH OF CUT L_2	OVERALL LENGTH L_1	SHANK DIAMETER D_2	REACH L_3	CORNER RADIUS R	TI-NAMITE-X (TX)
6,0	8,0	75,0	6,0	32,0	0,5	45127
6,0	8,0	75,0	6,0	32,0	1,0	45187
6,0	8,0	75,0	6,0	32,0	1,5	45188
8,0	10,0	75,0	8,0	32,0	0,5	45128
8,0	10,0	75,0	8,0	32,0	1,0	45129
8,0	10,0	75,0	8,0	32,0	1,5	45189
8,0	10,0	75,0	8,0	32,0	2,0	45190
10,0	12,0	100,0	10,0	40,0	0,5	45191
10,0	12,0	100,0	10,0	40,0	1,0	45130
10,0	12,0	100,0	10,0	40,0	1,5	45131
10,0	12,0	100,0	10,0	40,0	2,0	45132
10,0	12,0	100,0	10,0	40,0	2,5	45192
12,0	15,0	100,0	12,0	48,0	0,5	45193
12,0	15,0	100,0	12,0	48,0	0,76	45194
12,0	15,0	100,0	12,0	48,0	1,0	45133
12,0	15,0	100,0	12,0	48,0	1,5	45134
12,0	15,0	100,0	12,0	48,0	2,0	45135
12,0	15,0	100,0	12,0	48,0	2,5	45195
12,0	15,0	100,0	12,0	48,0	3,0	45196
16,0	20,0	115,0	16,0	65,0	1,0	45136
16,0	20,0	115,0	16,0	65,0	1,5	45137
16,0	20,0	115,0	16,0	65,0	2,0	45138
16,0	20,0	115,0	16,0	65,0	2,5	45197
16,0	20,0	115,0	16,0	65,0	3,0	45198
16,0	20,0	115,0	16,0	65,0	4,0	45199
20,0	24,0	150,0	20,0	80,0	1,0	45139
20,0	24,0	150,0	20,0	80,0	1,5	45140
20,0	24,0	150,0	20,0	80,0	2,0	45141
20,0	24,0	150,0	20,0	80,0	2,5	45200
20,0	24,0	150,0	20,0	80,0	3,0	45201
20,0	24,0	150,0	20,0	80,0	4,0	45202
20,0	24,0	150,0	20,0	80,0	5,0	45203

- Engineered for High Speed Milling using Trochoidal and Peel Milling techniques
- Eccentric relief provides superior strength and smoother surface finish
- Necked design with blended diameter transitions provide clearance to reach
- Enhanced corner geometry with tight tolerance corner radii
- Recommended for materials ≤ 45 HRC (≤ 420 Bhn)



Series 51M, 51MCR, 51ML, 51MLC Metric	Hardness	Ae x D1	Ap x D1	Vc (m/min)	Diameter (D1) (mm)								
					6	8	10	12	16	20			
P CARBON STEELS 1018, 1040, 1080, 1090, 10L50, 1140, 1212, 12L15, 1525, 1536	≤ 275 Bhn or ≤ 28 HRc	Profile 	≤ 0.1	≤ 1	219	RPM	11633	8725	6980	5816	4362	3490	
					(176-263)	Fz	0.048	0.081	0.101	0.121	0.142	0.158	
					Feed (mm/min)	3350	4240	4230	4223	3717	3308		
		HSM 	≤ 0.05	≤ 2	279	RPM	14784	11088	8870	7392	5544	4435	
					(223-335)	Fz	0.066	0.113	0.141	0.169	0.197	0.220	
					Feed (mm/min)	5854	7517	7504	7495	6553	5854		
	≤ 375 Bhn or ≤ 40 HRc	Profile 	≤ 0.1	≤ 1	149	RPM	7917	5938	4750	3958	2969	2375	
					(119-179)	Fz	0.036	0.061	0.077	0.092	0.107	0.119	
					Feed (mm/min)	1710	2173	2195	2185	1906	1696		
		HSM 	≤ 0.05	≤ 2	189	RPM	10017	7513	6010	5009	3756	3005	
					(151-227)	Fz	0.049	0.083	0.104	0.125	0.146	0.163	
					Feed (mm/min)	2945	3741	3750	3756	3291	2939		
H TOOL STEELS A2, D2, H13, L2, M2, P20, S7, T15, W2	≤ 375 Bhn or ≤ 40 HRc	Profile 	≤ 0.1	≤ 1	73	RPM	3878	2908	2327	1939	1454	1163	
					(59-88)	Fz	0.029	0.049	0.061	0.073	0.086	0.096	
					Feed (mm/min)	675	855	852	849	750	670		
		HSM 	≤ 0.05	≤ 2	93	RPM	4928	3696	2957	2464	1848	1478	
					(74-112)	Fz	0.040	0.069	0.086	0.103	0.120	0.134	
					Feed (mm/min)	1183	1530	1526	1523	1331	1189		
	M STAINLESS STEELS (FREE MACHINING) 303, 416, 420F, 430F, 440F	≤ 275 Bhn or ≤ 28 HRc	Profile 	≤ 0.1	≤ 1	155	RPM	8240	6180	4944	4120	3090	2472
						(140-171)	Fz	0.035	0.060	0.075	0.090	0.105	0.117
						Feed (mm/min)	1730	2225	2225	2225	1947	1735	
			HSM 	≤ 0.05	≤ 2	198	RPM	10502	7877	6301	5251	3938	3151
						(178-218)	Fz	0.048	0.082	0.102	0.122	0.143	0.159
						Feed (mm/min)	3025	3875	3856	3844	3379	3006	
≤ 275 Bhn or ≤ 28 HRc		Profile 	≤ 0.1	≤ 1	107	RPM	5655	4241	3393	2827	2121	1696	
					(96-117)	Fz	0.029	0.049	0.061	0.073	0.086	0.096	
					Feed (mm/min)	984	1247	1242	1238	1094	977		
		HSM 	≤ 0.05	≤ 2	137	RPM	7271	5453	4362	3635	2726	2181	
					(123-151)	Fz	0.040	0.069	0.086	0.103	0.120	0.134	
					Feed (mm/min)	1745	2258	2251	2247	1963	1754		
≤ 325 Bhn or ≤ 35 HRc	Profile 	≤ 0.1	≤ 1	99	RPM	5251	3938	3151	2626	1969	1575		
				(89-109)	Fz	0.029	0.049	0.061	0.073	0.086	0.096		
				Feed (mm/min)	914	1158	1153	1150	1016	907			
	HSM 	≤ 0.05	≤ 2	125	RPM	6624	4968	3975	3312	2484	1987		
				(112-137)	Fz	0.040	0.069	0.086	0.103	0.120	0.134		
				Feed (mm/min)	1590	2057	2051	2047	1789	1598			

continued on next page

Series 51M, 51MCR, 51ML, 51MLC Metric	Hardness			Vc (m/min)	Diameter (D ₁) (mm)							
		Ae x D ₁	Ap x D ₁		6	8	10	12	16	20		
SUPER ALLOYS (NICKEL, COBALT, IRON BASE) Inconel 601, 617, 625, Incoloy, Monel 400	≤ 300 Bhn or ≤ 32 HRc	Profile 	≤ 0.1	≤ 1	32	RPM	1696	1272	1018	848	636	509
					(26-38)	Fz	0.034	0.057	0.071	0.085	0.100	0.110
					Feed (mm/min)	346	435	434	433	382	336	
		HSM 	≤ 0.05	≤ 2	40	RPM	2100	1575	1260	1050	788	630
					(32-48)	Fz	0.046	0.077	0.097	0.120	0.140	0.150
					Feed (mm/min)	580	728	733	756	662	567	
SUPER ALLOYS (NICKEL, COBALT, IRON BASE) Inconel 718, X-750, Incoloy, Waspaloy, Hastelloy, Rene	≤ 400 Bhn or ≤ 43 HRc	Profile 	≤ 0.1	≤ 1	24	RPM	1293	969	776	646	485	388
					(20-29)	Fz	0.023	0.039	0.049	0.059	0.068	0.077
					Feed (mm/min)	178	227	228	229	198	179	
		HSM 	≤ 0.05	≤ 2	30	RPM	1616	1212	969	808	606	485
					(24-37)	Fz	0.032	0.054	0.068	0.081	0.095	0.110
					Feed (mm/min)	310	393	396	393	345	320	
TITANIUM ALLOYS Pure Titanium, Ti6Al4V, Ti6Al2Sn4Zr2Mo, Ti4Al4Mo2Sn0.5Si	≤ 350 Bhn or ≤ 38 HRc	Profile 	≤ 0.1	≤ 1	85	RPM	4524	3393	2714	2262	1696	1357
					(68-102)	Fz	0.023	0.039	0.049	0.059	0.068	0.077
					Feed (mm/min)	624	794	798	801	692	627	
		HSM 	≤ 0.05	≤ 2	108	RPM	5736	4302	3441	2868	2151	1721
					(87-130)	Fz	0.032	0.054	0.068	0.081	0.095	0.110
					Feed (mm/min)	1101	1394	1404	1394	1226	1136	
TITANIUM ALLOYS (DIFFICULT) Ti10Al2Fe3Al, Ti5Al5V5Mo3Cr, Ti7Al4Mo, Ti3Al8V6Cr4Zr4Mo, Ti6Al6V6Sn, Ti15V3 Cr3Sn3Al	≤ 440 Bhn or ≤ 47 HRc	Profile 	≤ 0.1	≤ 1	47	RPM	2504	1878	1503	1252	939	751
					(38-57)	Fz	0.023	0.039	0.049	0.059	0.068	0.077
					Feed (mm/min)	346	440	442	443	383	347	
		HSM 	≤ 0.05	≤ 2	61	RPM	3231	2424	1939	1616	1212	969
					(49-73)	Fz	0.032	0.054	0.068	0.081	0.095	0.110
					Feed (mm/min)	620	785	791	785	691	640	

Bhn (Brinell) HRc (Rockwell C) HSM (High Speed Machining)
 $rpm = (Vc \times 1000) / (D_1 \times 3.14)$
 $mm/min = Fz \times 6 \times rpm$
 reduce speed and feed for materials harder than listed
 reduce feed and Ae when finish milling (.02 x D₁ maximum)
 refer to the KYOCERA SGS Tool Wizard® for complete technical information (www.kyocera-sgstool.com)

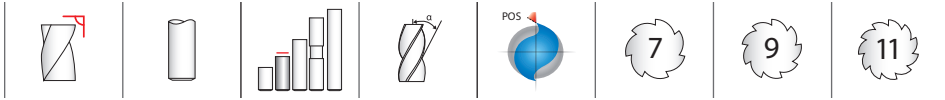

66
FRACTIONAL SERIES

- Heavy core and rigid design allow for straight walls
- High flute count design results in smoother cutting performance and enhanced tool life in precise finishing applications
- Recommended for materials ≤ 45 HRC (≤ 420 Bhn)

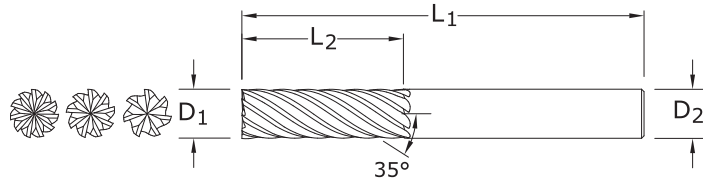

inch						EDP NO.
CUTTING DIAMETER D ₁	LENGTH OF CUT L ₂	OVERALL LENGTH L ₁	SHANK DIAMETER D ₂	NO. OF FLUTES		TI-NAMITE-X
3/16	5/8	2	3/16	7		36620
1/4	3/4	2-1/2	1/4	7		36621
3/8	1	3	3/8	7		36622
1/2	1-1/4	3	1/2	9		36623
5/8	1-5/8	3-1/2	5/8	9		36624
3/4	1-5/8	4	3/4	11		36625
1	2	6	1	11		36626

Neck Option Available

TOLERANCES (inch)

D₁ = +0.0000/-0.0020
D₂ = h₆

- STEELS
- STAINLESS STEELS
- CAST IRON
- HIGH TEMP ALLOYS
- TITANIUM
- HARDENED STEELS

For patent information visit www.ksptpatents.com

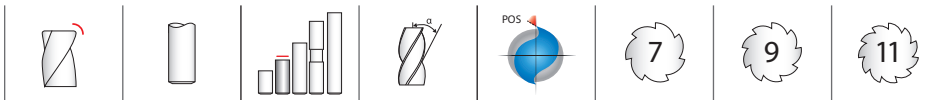

66CR
FRACTIONAL SERIES

- Heavy core and rigid design allow for straight walls
- High flute count design results in smoother cutting performance and enhanced tool life in precise finishing applications
- Enhanced corner geometry with tight tolerance corner radii
- Recommended for materials ≤ 45 HRC (≤ 420 Bhn)

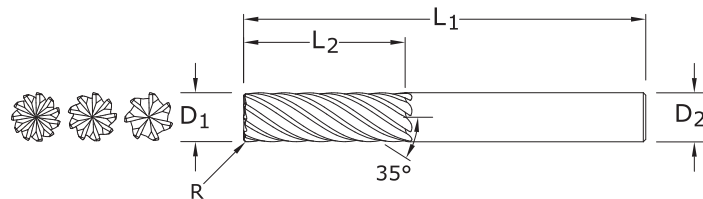

inch						EDP NO.
CUTTING DIAMETER D ₁	LENGTH OF CUT L ₂	OVERALL LENGTH L ₁	SHANK DIAMETER D ₂	CORNER RADIUS R	NO. OF FLUTES	TI-NAMITE-X
3/16	5/8	2	3/16	.010	7	36627
1/4	3/4	2-1/2	1/4	.015	7	36628
3/8	1	3	3/8	.015	7	36629
1/2	1-1/4	3	1/2	.030	9	36630
1/2	1-1/4	3	1/2	.090	9	36631
1/2	1-1/4	3	1/2	.120	9	36632
5/8	1-5/8	3-1/2	5/8	.030	9	36633
5/8	1-5/8	3-1/2	5/8	.090	9	36634
5/8	1-5/8	3-1/2	5/8	.120	9	36635
3/4	1-5/8	4	3/4	.030	11	36636
3/4	1-5/8	4	3/4	.090	11	36637
3/4	1-5/8	4	3/4	.120	11	36638
1	2	6	1	.030	11	36639
1	2	6	1	.090	11	36640
1	2	6	1	.120	11	36641

Neck Option Available







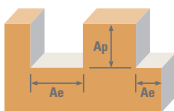

TOLERANCES (inch)

D₁ = +0.0000/-0.0020
D₂ = h₆
R = +0.0000/-0.0020

- STEELS
- STAINLESS STEELS
- CAST IRON
- HIGH TEMP ALLOYS
- TITANIUM
- HARDENED STEELS

For patent information visit www.ksptpatents.com



Series	Hardness	Ae x D ₁	Ap x D ₁	Vc (sfm)	Diameter (D ₁) (inch)								
					3/16	1/4	3/8	1/2	5/8	3/4	1		
P	CARBON STEELS 1018, 1040, 1080, 1090, 10L50, 1140, 1212, 12L15, 1525, 1536	Profile 	≤ 0.05	≤ 1	635	RPM	12937	9703	6469	4851	3881	3234	2426
					(508-762)	Fz	0.0008	0.0012	0.0022	0.0030	0.0037	0.0038	0.0042
					Feed (ipm)	72.4	81.5	99.6	131.0	129.2	135.2	112.1	
		Finish 	≤ 0.02	≤ 2	762	RPM	15524	11643	7762	5822	4657	3881	2911
					(610-914)	Fz	0.0006	0.0010	0.0018	0.0024	0.0030	0.0030	0.0034
					Feed (ipm)	69.5	78.2	95.6	125.7	124.1	129.8	107.6	
	ALLOY STEELS 4140, 4150, 4320, 5120, 5150, 8630, 86L20, 50100	Profile 	≤ 0.05	≤ 1	360	RPM	7334	5501	3667	2750	2200	1834	1375
					(288-432)	Fz	0.0006	0.0009	0.0017	0.0023	0.0029	0.0030	0.0032
					Feed (ipm)	30.8	34.7	43.6	56.9	57.4	60.5	48.4	
		Finish 	≤ 0.02	≤ 2	432	RPM	8801	6601	4401	3300	2640	2200	1650
					(346-518)	Fz	0.0005	0.0007	0.0014	0.0018	0.0023	0.0024	0.0026
					Feed (ipm)	29.6	33.3	41.9	54.7	55.1	58.1	46.5	
H	Profile 	≤ 0.05	≤ 1	290	RPM	5908	4431	2954	2216	1772	1477	1108	
				(232-348)	Fz	0.0004	0.0006	0.0012	0.0016	0.0020	0.0021	0.0022	
				Feed (ipm)	16.5	18.6	24.8	31.9	31.9	34.1	26.8		
	Finish 	≤ 0.02	≤ 2	348	RPM	7090	5317	3545	2659	2127	1772	1329	
				(278-418)	Fz	0.0003	0.0005	0.0010	0.0013	0.0016	0.0017	0.0018	
				Feed (ipm)	15.9	17.9	23.8	30.6	30.6	32.8	25.7		
K	CAST IRONS (LOW & MEDIUM ALLOY) Gray, Malleable, Ductile	Profile 	≤ 0.05	≤ 1	705	RPM	14363	10772	7182	5386	4309	3591	2693
					(564-846)	Fz	0.0008	0.0012	0.0022	0.0030	0.0037	0.0038	0.0042
					Feed (ipm)	80.4	90.5	110.6	145.4	143.5	150.1	124.4	
		Finish 	≤ 0.02	≤ 2	846	RPM	17236	12927	8618	6463	5171	4309	3232
					(677-1015)	Fz	0.0006	0.0010	0.0018	0.0024	0.0030	0.0030	0.0034
					Feed (ipm)	77.2	86.9	106.2	139.6	137.7	144.1	119.4	
	CAST IRONS (HIGH ALLOY) Gray, Malleable, Ductile	Profile 	≤ 0.05	≤ 1	540	RPM	11002	8251	5501	4126	3300	2750	2063
					(432-648)	Fz	0.0006	0.0009	0.0017	0.0023	0.0029	0.0030	0.0032
					Feed (ipm)	46.2	52.0	65.5	85.4	86.1	90.8	72.6	
		Finish 	≤ 0.02	≤ 2	648	RPM	13202	9901	6601	4951	3961	3300	2475
					(518-778)	Fz	0.0005	0.0007	0.0014	0.0018	0.0023	0.0024	0.0026
					Feed (ipm)	44.4	49.9	62.8	82.0	82.7	87.1	69.7	
M	Profile 	≤ 0.05	≤ 1	560	RPM	11409	8557	5705	4278	3423	2852	2139	
				(448-672)	Fz	0.0006	0.0009	0.0017	0.0023	0.0029	0.0030	0.0032	
				Feed (ipm)	47.9	53.9	67.9	88.6	89.3	94.1	75.3		
	Finish 	≤ 0.02	≤ 2	448	RPM	9127	6845	4564	3423	2738	2282	1711	
				(358-538)	Fz	0.0005	0.0007	0.0014	0.0018	0.0023	0.0024	0.0026	
				Feed (ipm)	30.7	34.5	43.4	56.7	57.2	60.2	48.2		

continued on next page

FRACTIONAL Multi-Carb

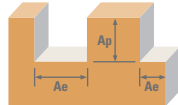

Series 66, 66CR Fractional	Hardness	Profile Ae x D ₁	Finish Ap x D ₁	Vc (sfm)	Diameter (D ₁) (inch)							
					3/16	1/4	3/8	1/2	5/8	3/4	1	
M	STAINLESS STEELS (DIFFICULT) 304, 304L, 316, 316L	Profile ≤ 0.05	≤ 1	385	RPM	7844	5883	3922	2941	2353	1961	1471
				(308-462)	Fz	0.0005	0.0007	0.0014	0.0018	0.0023	0.0024	0.0026
				Feed (ipm)	27.5	28.8	38.4	47.7	48.7	51.8	42.1	
		Finish ≤ 0.02	≤ 2	462	RPM	9412	7059	4706	3530	2824	2353	1765
				(370-554)	Fz	0.0004	0.0006	0.0011	0.0014	0.0018	0.0019	0.0021
				Feed (ipm)	26.4	27.7	36.9	45.7	46.8	49.7	40.4	
	STAINLESS STEELS (PH) 13-8 PH, 15-5 PH, 17-4 PH, Custom 450	Profile ≤ 0.05	≤ 1	355	RPM	7233	5424	3616	2712	2170	1808	1356
				(284-426)	Fz	0.0005	0.0007	0.0014	0.0018	0.0023	0.0024	0.0026
				Feed (ipm)	25.3	26.6	35.4	43.9	44.9	47.7	38.8	
		Finish ≤ 0.02	≤ 2	426	RPM	8679	6509	4340	3255	2604	2170	1627
				(341-511)	Fz	0.0004	0.0006	0.0011	0.0014	0.0018	0.0019	0.0021
				Feed (ipm)	24.3	25.5	34.0	42.2	43.1	45.8	37.2	
S	SUPER ALLOYS (NICKEL, COBALT, IRON BASE) Inconel 601, 617, 625, Incoloy, Monel 400	Profile ≤ 0.05	≤ 1	105	RPM	2139	1604	1070	802	642	535	401
				(84-126)	Fz	0.0005	0.0007	0.0014	0.0018	0.0023	0.0024	0.0026
				Feed (ipm)	7.5	7.9	10.5	13.0	13.3	14.1	11.5	
		Finish ≤ 0.02	≤ 2	126	RPM	2567	1925	1284	963	770	642	481
				(101-151)	Fz	0.0004	0.0006	0.0011	0.0014	0.0018	0.0019	0.0021
				Feed (ipm)	7.2	7.5	10.1	12.5	12.8	13.6	11.0	
	SUPER ALLOYS (NICKEL, COBALT, IRON BASE) Inconel 718, X-750, Incoloy, Waspaloy, Hastelloy, Rene	Profile ≤ 0.05	≤ 1	85	RPM	1732	1299	866	649	520	433	325
				(68-102)	Fz	0.0003	0.0005	0.0009	0.0011	0.0014	0.0015	0.0016
				Feed (ipm)	3.6	4.5	5.5	6.4	6.5	7.1	5.7	
		Finish ≤ 0.02	≤ 2	102	RPM	2078	1559	1039	779	623	520	390
				(82-122)	Fz	0.0002	0.0004	0.0007	0.0009	0.0011	0.0012	0.0013
				Feed (ipm)	3.5	4.4	5.2	6.2	6.3	6.9	5.5	
TITANIUM ALLOYS Pure Titanium, Ti6Al4V, Ti6Al2Sn4Zr2Mo, Ti4Al4Mo2Sn0.5Si	Profile ≤ 0.05	≤ 1	390	RPM	7946	5959	3973	2980	2384	1986	1490	
			(312-468)	Fz	0.0005	0.0008	0.0015	0.0021	0.0026	0.0027	0.0029	
			Feed (ipm)	27.8	33.4	41.7	56.3	55.8	59.0	47.5		
	Finish ≤ 0.02	≤ 2	468	RPM	9535	7151	4767	3576	2860	2384	1788	
			(374-562)	Fz	0.0004	0.0006	0.0012	0.0017	0.0021	0.0022	0.0023	
			Feed (ipm)	26.7	32.0	40.0	54.1	53.5	56.6	45.6		
TITANIUM ALLOYS (DIFFICULT) Ti10Al2Fe3Al, Ti5Al5V5Mo3Cr, Ti7Al4Mo, Ti3Al8V6Cr4Zr4Mo, Ti6Al6V6Sn, Ti15V3 Cr3Sn3Al	Profile ≤ 0.05	≤ 1	140	RPM	2852	2139	1426	1070	856	713	535	
			(112-168)	Fz	0.0005	0.0008	0.0015	0.0021	0.0026	0.0027	0.0029	
			Feed (ipm)	10.0	12.0	15.0	20.2	20.0	21.2	17.1		
	Finish ≤ 0.02	≤ 2	168	RPM	3423	2567	1711	1284	1027	856	642	
			(134-202)	Fz	0.0004	0.0006	0.0012	0.0017	0.0021	0.0022	0.0023	
			Feed (ipm)	9.6	11.5	14.4	19.4	19.2	20.3	16.4		

Bhn (Brinell) HRc (Rockwell C)

rpm = Vc x 3.82 / D₁

ipm = Fz x number of flutes x rpm

reduce speed and feed for materials harder than listed

refer to the KYOCERA SGS Tool Wizard® for complete technical information (www.kyocera-sgstool.com)

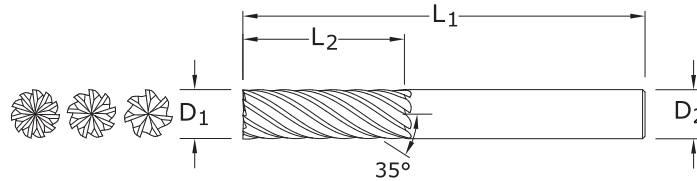
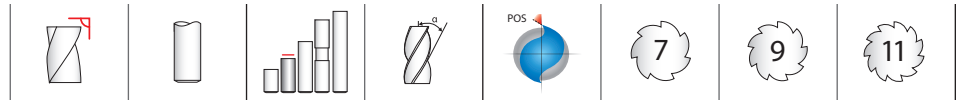

66M
METRIC SERIES

TOLERANCES (mm)

$D_1 = +0,000/-0,050$
 $D_2 = h_6$

- STEELS
- STAINLESS STEELS
- CAST IRON
- HIGH TEMP ALLOYS
- TITANIUM
- HARDENED STEELS

For patent information visit www.ksptpatents.com

mm					EDP NO.
CUTTING DIAMETER D_1	LENGTH OF CUT L_2	OVERALL LENGTH L_1	SHANK DIAMETER D_2	NO. OF FLUTES	TI-NAMITE-X
6,0	19,0	63,0	6,0	7	46620
8,0	20,0	63,0	8,0	7	46621
10,0	22,0	75,0	10,0	7	46622
12,0	26,0	83,0	12,0	9	46623
16,0	32,0	92,0	16,0	9	46624
20,0	38,0	104,0	20,0	11	46625
25,0	38,0	104,0	25,0	11	46626

Neck Option Available

- Heavy core and rigid design allow for straight walls
- High flute count design results in smoother cutting performance and enhanced tool life in precise finishing applications
- Recommended for materials ≤ 45 HRc (≤ 420 Bhn)

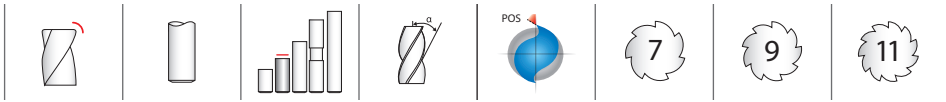

66MCR
METRIC SERIES

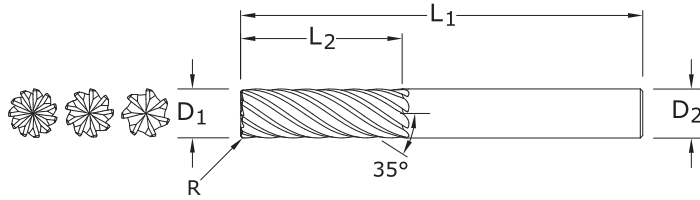

- Heavy core and rigid design allow for straight walls
- High flute count design results in smoother cutting performance and enhanced tool life in precise finishing applications
- Enhanced corner geometry with tight tolerance corner radii
- Recommended for materials ≤ 45 HRc (≤ 420 Bhn)

mm						EDP NO.
CUTTING DIAMETER D ₁	LENGTH OF CUT L ₂	OVERALL LENGTH L ₁	SHANK DIAMETER D ₂	CORNER RADIUS R	NO. OF FLUTES	TI-NAMITE-X
6,0	19,0	63,0	6,0	0,5	7	46627
6,0	19,0	63,0	6,0	1,0	7	46628
8,0	20,0	63,0	8,0	0,5	7	46629
8,0	20,0	63,0	8,0	1,0	7	46630
8,0	20,0	63,0	8,0	1,5	7	46631
10,0	22,0	75,0	10,0	0,5	7	46632
10,0	22,0	75,0	10,0	1,0	7	46633
10,0	22,0	75,0	10,0	1,5	7	46634
10,0	22,0	75,0	10,0	2,0	7	46635
12,0	26,0	83,0	12,0	1,0	9	46636
12,0	26,0	83,0	12,0	1,5	9	46637
12,0	26,0	83,0	12,0	2,0	9	46638
12,0	26,0	83,0	12,0	2,5	9	46639
12,0	26,0	83,0	12,0	3,0	9	46640
16,0	32,0	92,0	16,0	1,0	9	46641
16,0	32,0	92,0	16,0	1,5	9	46642
16,0	32,0	92,0	16,0	2,0	9	46643
16,0	32,0	92,0	16,0	2,5	9	46644
16,0	32,0	92,0	16,0	3,0	9	46645
16,0	32,0	92,0	16,0	4,0	9	46646

TOLERANCES (mm)

D₁ = +0,000/-0,050
D₂ = h₆
R = +0,000/-0,050

- STEELS
- STAINLESS STEELS
- CAST IRON
- HIGH TEMP ALLOYS
- TITANIUM
- HARDENED STEELS

For patent information visit www.ksptpatents.com

continued on next page

Neck Option Available

66MCR
METRIC SERIES

CUTTING DIAMETER D ₁	LENGTH OF CUT L ₂	mm			NO. OF FLUTES	EDP NO.
		OVERALL LENGTH L ₁	SHANK DIAMETER D ₂	CORNER RADIUS R		TI-NAMITE-X
20,0	38,0	104,0	20,0	1,0	11	46647
20,0	38,0	104,0	20,0	1,5	11	46648
20,0	38,0	104,0	20,0	2,0	11	46649
20,0	38,0	104,0	20,0	2,5	11	46650
20,0	38,0	104,0	20,0	3,0	11	46651
20,0	38,0	104,0	20,0	4,0	11	46652
20,0	38,0	104,0	20,0	5,0	11	46653
25,0	38,0	104,0	25,0	1,0	11	46654
25,0	38,0	104,0	25,0	1,5	11	46655
25,0	38,0	104,0	25,0	2,0	11	46656
25,0	38,0	104,0	25,0	2,5	11	46657
25,0	38,0	104,0	25,0	3,0	11	46658
25,0	38,0	104,0	25,0	4,0	11	46659
25,0	38,0	104,0	25,0	5,0	11	46660

CONTINUED

Neck Option Available

Multi-Carb

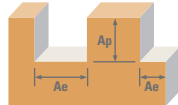

Series 66M, 66MCR Metric	Hardness	Ae x D ₁	Ap x D ₁	Vc (m/min)	Diameter (D ₁) (mm)								
					6	8	10	12	16	20	25		
P CARBON STEELS 1018, 1040, 1080, 1090, 10L50, 1140, 1212, 12L15, 1525, 1536	≤ 275 Bhn or ≤ 28 HRc	Profile 	≤ 0.05	≤ 1	194	RPM	10260	7695	6156	5130	3847	3078	2462
					(155-232)	Fz	0.029	0.047	0.059	0.072	0.095	0.101	0.105
					Feed (mm/min)	2068	2528	2528	3324	3280	3431	2844	
	≤ 275 Bhn or ≤ 28 HRc	Finish 	≤ 0.02	≤ 2	232	RPM	12312	9234	7387	6156	4617	3693	2955
					(186-279)	Fz	0.023	0.038	0.047	0.058	0.076	0.081	0.084
					Feed (mm/min)	1985	2427	2427	3191	3149	3294	2730	
H ALLOY STEELS 4140, 4150, 4320, 5120, 5150, 8630, 86L20, 50100	≤ 375 Bhn or ≤ 40 HRc	Profile 	≤ 0.05	≤ 1	110	RPM	5816	4362	3490	2908	2181	1745	1396
					(88-132)	Fz	0.022	0.036	0.045	0.055	0.074	0.080	0.080
					Feed (mm/min)	879	1108	1107	1445	1457	1536	1229	
	≤ 375 Bhn or ≤ 40 HRc	Finish 	≤ 0.02	≤ 2	132	RPM	6980	5235	4188	3490	2617	2094	1675
					(105-158)	Fz	0.017	0.029	0.036	0.044	0.059	0.064	0.064
					Feed (mm/min)	844	1063	1063	1387	1399	1474	1179	
K TOOL STEELS A2, D2, H13, L2, M2, P20, S7, T15, W2	≤ 375 Bhn or ≤ 40 HRc	Profile 	≤ 0.05	≤ 1	88	RPM	4686	3514	2811	2343	1757	1406	1125
					(71-106)	Fz	0.014	0.026	0.032	0.038	0.051	0.056	0.055
					Feed (mm/min)	472	630	630	810	810	866	680	
	≤ 375 Bhn or ≤ 40 HRc	Finish 	≤ 0.02	≤ 2	106	RPM	5623	4217	3374	2811	2108	1687	1349
					(85-127)	Fz	0.012	0.020	0.026	0.031	0.041	0.045	0.044
					Feed (mm/min)	453	605	605	777	777	831	653	
M CAST IRONS (LOW & MEDIUM ALLOY) Gray, Malleable, Ductile	≤ 220 Bhn or ≤ 19 HRc	Profile 	≤ 0.05	≤ 1	215	RPM	11391	8543	6834	5695	4271	3417	2734
					(172-258)	Fz	0.029	0.047	0.059	0.072	0.095	0.101	0.105
					Feed (mm/min)	2296	2807	2807	3690	3641	3809	3158	
	≤ 220 Bhn or ≤ 19 HRc	Finish 	≤ 0.02	≤ 2	258	RPM	13669	10252	8201	6834	5126	4101	3281
					(206-309)	Fz	0.023	0.038	0.047	0.058	0.076	0.081	0.084
					Feed (mm/min)	2204	2695	2694	3543	3496	3657	3031	
M CAST IRONS (HIGH ALLOY) Gray, Malleable, Ductile	≤ 260 Bhn or ≤ 26 HRc	Profile 	≤ 0.05	≤ 1	165	RPM	8725	6544	5235	4362	3272	2617	2094
					(132-198)	Fz	0.022	0.036	0.045	0.055	0.074	0.080	0.080
					Feed (mm/min)	1319	1661	1661	2167	2186	2303	1843	
	≤ 260 Bhn or ≤ 26 HRc	Finish 	≤ 0.02	≤ 2	198	RPM	10470	7852	6282	5235	3926	3141	2513
					(158-237)	Fz	0.017	0.029	0.036	0.044	0.059	0.064	0.064
					Feed (mm/min)	1266	1595	1595	2080	2099	2211	1769	
M STAINLESS STEELS (FREE MACHINING) 303, 416, 420F, 430F, 440F	≤ 275 Bhn or ≤ 28 HRc	Profile 	≤ 0.05	≤ 1	171	RPM	9048	6786	5429	4524	3393	2714	2171
					(137-205)	Fz	0.022	0.036	0.045	0.055	0.074	0.080	0.080
					Feed (mm/min)	1368	1723	1723	2247	2267	2389	1911	
	≤ 275 Bhn or ≤ 28 HRc	Finish 	≤ 0.02	≤ 2	137	RPM	7238	5429	4343	3619	2714	2171	1737
					(109-164)	Fz	0.017	0.029	0.036	0.044	0.059	0.064	0.064
					Feed (mm/min)	875	1103	1103	1438	1451	1529	1223	

continued on next page

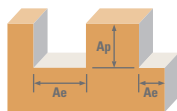

Series 66M, 66MCR Metric	Hardness	Ae x D ₁	Ap x D ₁	Vc (m/min)	Diameter (D ₁) (mm)								
					6	8	10	12	16	20	25		
M	STAINLESS STEELS (DIFFICULT) 304, 304L, 316, 316L ≤ 275 Bhn or ≤ 28 HRc	Profile 	≤ 0.05	≤ 1	117	RPM	6220	4665	3732	3110	2333	1866	1493
					(94-141)	Fz	0.017	0.030	0.037	0.043	0.059	0.064	0.065
					Feed (mm/min)	731	975	975	1209	1236	1314	1067	
		Finish 	≤ 0.02	≤ 2	141	RPM	7465	5598	4479	3732	2799	2239	1791
					(113-169)	Fz	0.013	0.024	0.030	0.035	0.047	0.051	0.052
					Feed (mm/min)	702	17	936	1161	1187	1261	1025	
	STAINLESS STEELS (PH) 13-8 PH, 15-5 PH, 17-4 PH, Custom 450 ≤ 325 Bhn or ≤ 35 HRc	Profile 	≤ 0.05	≤ 1	108	RPM	5736	4302	3441	2868	2151	1721	1377
					(87-130)	Fz	0.017	0.030	0.037	0.043	0.059	0.064	0.065
					Feed (mm/min)	674	899	899	1115	1140	1211	984	
		Finish 	≤ 0.02	≤ 2	130	RPM	6883	5162	4130	3441	2581	2065	1652
					(104-156)	Fz	0.013	0.024	0.030	0.035	0.047	0.051	0.052
					Feed (mm/min)	647	863	863	1070	1094	1163	945	
S	SUPER ALLOYS (NICKEL, COBALT, IRON BASE) Inconel 601, 617, 625, Incoloy, Monel 400 ≤ 300 Bhn or ≤ 32 HRc	Profile 	≤ 0.05	≤ 1	32	RPM	1696	1272	1018	848	636	509	407
					(26-38)	Fz	0.017	0.030	0.037	0.043	0.059	0.064	0.065
					Feed (mm/min)	199	266	213	330	337	358	291	
		Finish 	≤ 0.02	≤ 2	38	RPM	2036	1527	1221	1018	763	611	489
					(31-46)	Fz	0.013	0.024	0.030	0.035	0.047	0.051	0.052
					Feed (mm/min)	192	255	255	317	324	344	279	
	SUPER ALLOYS (NICKEL, COBALT, IRON BASE) Inconel 718, X-750, Incoloy, Waspaloy, Hastelloy, Rene ≤ 400 Bhn or ≤ 43 HRc	Profile 	≤ 0.05	≤ 1	26	RPM	1373	1030	824	687	515	412	330
					(21-31)	Fz	0.012	0.019	0.024	0.026	0.036	0.040	0.040
					Feed (mm/min)	115	138	138	163	166	181	145	
		Finish 	≤ 0.02	≤ 2	31	RPM	1648	1236	989	824	618	494	396
					(25-37)	Fz	0.010	0.015	0.019	0.021	0.029	0.032	0.032
					Feed (mm/min)	111	133	133	157	159	174	139	
TITANIUM ALLOYS Pure Titanium, Ti6Al4V, Ti6Al2Sn4Zr2Mo, Ti4Al4Mo2Sn0.5Si ≤ 350 Bhn or ≤ 38 HRc	Profile 	≤ 0.05	≤ 1	119	RPM	6301	4726	3781	3151	2363	1890	1512	
				(95-143)	Fz	0.019	0.032	0.040	0.050	0.067	0.072	0.073	
				Feed (mm/min)	847	1059	1059	1429	1415	1497	1206		
	Finish 	≤ 0.02	≤ 2	143	RPM	7561	5671	4537	3781	2836	2268	1815	
				(114-171)	Fz	0.015	0.026	0.032	0.040	0.053	0.058	0.058	
				Feed (mm/min)	813	1016	1016	1372	1359	1437	1158		
TITANIUM ALLOYS (DIFFICULT) Ti10Al2Fe3Al, Ti5Al5V5Mo3Cr, Ti7Al4Mo, Ti3Al8V6Cr4Zr4Mo, Ti6Al6V6Sn, Ti15V3 Cr3Sn3Al ≤ 440 Bhn or ≤ 47 HRc	Profile 	≤ 0.05	≤ 1	43	RPM	2262	1696	1357	1131	848	679	543	
				(34-51)	Fz	0.019	0.032	0.040	0.050	0.067	0.072	0.073	
				Feed (mm/min)	304	380	380	513	508	537	433		
	Finish 	≤ 0.02	≤ 2	51	RPM	2714	2036	1629	1357	1018	814	651	
				(41-61)	Fz	0.015	0.026	0.032	0.040	0.053	0.058	0.058	
				Feed (mm/min)	292	365	365	492	488	516	416		

Bhn (Brinell) HRc (Rockwell C)
 $rpm = (Vc \times 1000) / (D_1 \times 3.14)$
 $mm/min = Fz \times \text{number of flutes} \times rpm$
 reduce speed and feed for materials harder than listed
 refer to the KYOCERA SGS Tool Wizard® for complete technical information (www.kyocera-sgstool.com)

FRACTIONAL Series 33

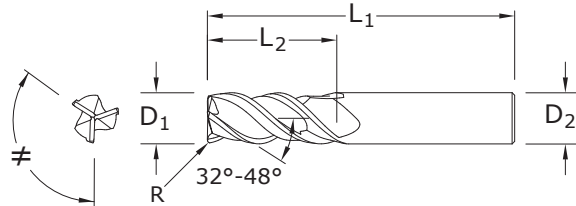

33CR FRACTIONAL SERIES

- Specially engineered step core design provides stability for aggressive ramping and rigidity when flutes are completely engaged
- Open design at axial end accommodates material flow and load reduction during machining operations
- Enhanced corner geometry with tight tolerance corner radii
- Recommended for materials ≤ 45 HRC (≤ 420 Bhn)

CUTTING DIAMETER D_1	LENGTH OF CUT L_2	inch			CORNER RADIUS R	EDP NO. TI-NAMITE-A (AITiN)
		OVERALL LENGTH L_1	SHANK DIAMETER D_2			
1/8	3/8	2-1/2	1/4	.015	33345	
3/16	9/16	2-1/2	1/4	.015	33346	
1/4	3/4	2-1/2	1/4	.020	33347	
5/16	13/16	2-1/2	5/16	.020	33348	
3/8	1	2-1/2	3/8	.020	33349	
7/16	1-1/8	2-3/4	7/16	.020	33350	
1/2	1-1/4	3-1/4	1/2	.030	33351	
5/8	1-1/2	3-1/2	5/8	.040	33352	
3/4	1-3/4	4	3/4	.040	33353	
1	2-1/4	5	1	.040	33354	

TOLERANCES (inch)

1/8–1/4 DIAMETER

$D_1 = +0.0000/-0.0012$

$D_2 = h6$

$R = +0.0000/-0.0020$

>1/4–3/8 DIAMETER

$D_1 = +0.0000/-0.0016$

$D_2 = h6$

$R = +0.0000/-0.0020$

>3/8–1 DIAMETER

$D_1 = +0.0000/-0.0020$

$D_2 = h6$

$R = +0.0000/-0.0020$

STEELS

STAINLESS STEELS

CAST IRON

HIGH TEMP ALLOYS

TITANIUM

HARDENED STEELS

For patent information visit www.ksptpatents.com

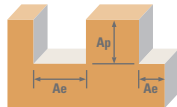

Series 33CR Fractional	Hardness	Ae x D ₁	Ap x D ₁	Vc (sfm)	Diameter (D ₁) (inch)									
					1/8	1/4	3/8	1/2	5/8	3/4	1			
P CARBON STEELS 1018, 1040, 1080, 1090, 10L50, 1140, 1212, 12L15, 1525, 1536	≤ 275 Bhn or ≤ 28 HRc	Profile 	≤ 0.5	≤ 1.5	550	RPM	16808	8404	5603	4202	3362	2801	2101	
					(440-660)	Fz	0.0005	0.0012	0.0023	0.0031	0.0039	0.0040	0.0043	
					Feed (ipm)	25.2	30.3	38.7	39.1	39.3	33.6	27.1		
		Slot 	1	≤ 1	440	RPM	13446	6723	4482	3362	2689	2241	1681	
					(352-528)	Fz	0.0005	0.0012	0.0023	0.0031	0.0039	0.0040	0.0043	
					Feed (ipm)	20.2	24.2	30.9	31.3	31.5	26.9	21.7		
	ALLOY STEELS 4140, 4150, 4320, 5120, 5150, 8630, 86L20, 50100	≤ 375 Bhn or ≤ 40 HRc	Profile 	≤ 0.5	≤ 1.5	315	RPM	9626	4813	3209	2407	1925	1604	1203
						(252-378)	Fz	0.0004	0.0009	0.0017	0.0023	0.0029	0.0030	0.0032
						Feed (ipm)	11.6	13.0	16.4	16.6	16.7	14.4	11.6	
			Slot 	1	≤ 1	250	RPM	7640	3820	2547	1910	1528	1273	955
						(200-300)	Fz	0.0004	0.0009	0.0017	0.0023	0.0029	0.0030	0.0032
						Feed (ipm)	9.2	10.3	13.0	13.2	13.3	11.5	9.2	
H TOOL STEELS A2, D2, H13, L2, M2, P20, S7, T15, W2	≤ 375 Bhn or ≤ 40 HRc	Profile 	≤ 0.5	≤ 1.5	185	RPM	5654	2827	1885	1413	1131	942	707	
					(148-222)	Fz	0.0003	0.0007	0.0014	0.0018	0.0023	0.0024	0.0025	
					Feed (ipm)	5.1	5.9	7.9	7.6	7.8	6.8	5.3		
		Slot 	1	≤ 1	145	RPM	4431	2216	1477	1108	886	739	554	
					(116-174)	Fz	0.0003	0.0007	0.0014	0.0018	0.0023	0.0024	0.0025	
					Feed (ipm)	4.0	4.7	6.2	6.0	6.1	5.3	4.2		
K CAST IRONS (LOW & MEDIUM ALLOY) Gray, Malleable, Ductile	≤ 220 Bhn or ≤ 19 HRc	Profile 	≤ 0.5	≤ 1.5	445	RPM	13599	6800	4533	3400	2720	2267	1700	
					(356-534)	Fz	0.0004	0.0011	0.0021	0.0028	0.0035	0.0036	0.0039	
					Feed (ipm)	14.3	22.4	28.6	28.6	28.6	24.5	19.9		
		Slot 	1	≤ 1	355	RPM	10849	5424	3616	2712	2170	1808	1356	
					(284-426)	Fz	0.0004	0.0011	0.0021	0.0028	0.0035	0.0036	0.0039	
					Feed (ipm)	11.4	17.9	22.8	22.8	22.8	19.5	15.9		
	CAST IRONS (HIGH ALLOY) Gray, Malleable, Ductile	≤ 260 Bhn or ≤ 26 HRc	Profile 	≤ 0.5	≤ 1.5	340	RPM	10390	5195	3463	2598	2078	1732	1299
						(272-408)	Fz	0.0003	0.0008	0.0016	0.0021	0.0026	0.0027	0.0029
						Feed (ipm)	9.4	12.5	16.6	16.4	16.2	14.0	11.3	
			Slot 	1	≤ 1	270	RPM	8251	4126	2750	2063	1650	1375	1031
						(216-324)	Fz	0.0003	0.0008	0.0016	0.0021	0.0026	0.0027	0.0029
						Feed (ipm)	7.4	9.9	13.2	13.0	12.9	11.1	9.0	
M STAINLESS STEELS (FREE MACHINING) 303, 416, 420F, 430F, 440F	≤ 275 Bhn or ≤ 28 HRc	Profile 	≤ 0.5	≤ 1.5	490	RPM	14974	7487	4991	3744	2995	2496	1872	
					(392-588)	Fz	0.0004	0.0010	0.0019	0.0025	0.0031	0.0032	0.0035	
					Feed (ipm)	17.1	22.5	28.5	28.1	27.9	24.0	19.7		
		Slot 	1	≤ 1	390	RPM	11918	5959	3973	2980	2384	1986	1490	
					(312-468)	Fz	0.0004	0.0010	0.0019	0.0025	0.0031	0.0032	0.0035	
					Feed (ipm)	13.6	17.9	22.6	22.3	22.2	19.1	15.6		

continued on next page

FRACTIONAL Series 33

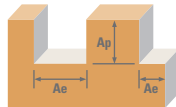

Series 33CR Fractional	Hardness	Ae x D ₁	Ap x D ₁	Vc (sfm)	Diameter (D ₁) (inch)									
					1/8	1/4	3/8	1/2	5/8	3/4	1			
M STAINLESS STEELS (DIFFICULT) 304, 304L, 316, 316L	≤ 275 Bhn or ≤ 28 HRc	Profile 	≤ 0.5	≤ 1.5	340	RPM	10390	5195	3463	2598	2078	1732	1299	
					(272-408)	Fz	0.0003	0.0008	0.0015	0.0020	0.0025	0.0026	0.0028	
					Feed (ipm)	9.4	12.5	15.6	15.6	15.6	13.5	10.9		
		Slot 	1	≤ 1	270	RPM	8251	4126	2750	2063	1650	1375	1031	
					(216-324)	Fz	0.0003	0.0008	0.0015	0.0020	0.0025	0.0026	0.0028	
					Feed (ipm)	7.4	9.9	12.4	12.4	12.4	10.7	8.7		
	STAINLESS STEELS (PH) 13-8 PH, 15-5 PH, 17-4 PH, Custom 450	≤ 325 Bhn or ≤ 35 HRc	Profile 	≤ 0.5	≤ 1.5	310	RPM	9474	4737	3158	2368	1895	1579	1184
						(248-372)	Fz	0.0003	0.0008	0.0015	0.0020	0.0025	0.0026	0.0028
						Feed (ipm)	8.5	11.4	14.2	14.2	14.2	12.3	9.9	
			Slot 	1	≤ 1	250	RPM	7640	3820	2547	1910	1528	1273	955
						(200-300)	Fz	0.0003	0.0008	0.0015	0.0020	0.0025	0.0026	0.0028
						Feed (ipm)	6.9	9.2	11.5	11.5	11.5	9.9	8.0	
S SUPER ALLOYS (NICKEL, COBALT, IRON BASE) Inconel 601, 617, 625, Incoloy, Monel 400	≤ 300 Bhn or ≤ 32 HRc	Profile 	≤ 0.5	≤ 1.5	80	RPM	2445	1222	815	611	489	407	306	
					(64-96)	Fz	0.0003	0.0007	0.0013	0.0017	0.0021	0.0022	0.0024	
					Feed (ipm)	1.9	2.6	3.2	3.1	3.1	2.7	2.2		
		Slot 	1	≤ 1	65	RPM	1986	993	662	497	397	331	248	
					(52-78)	Fz	0.0003	0.0007	0.0013	0.0017	0.0021	0.0022	0.0024	
					Feed (ipm)	1.5	2.1	2.6	2.5	2.5	2.2	1.8		
	SUPER ALLOYS (NICKEL, COBALT, IRON BASE) Inconel 718, X-750, Incoloy, Waspaloy, Hastelloy, Rene	≤ 400 Bhn or ≤ 43 HRc	Profile 	≤ 0.5	≤ 1.5	62	RPM	1895	947	632	474	379	316	237
						(50-74)	Fz	0.0002	0.0005	0.0009	0.0012	0.0015	0.0016	0.0017
						Feed (ipm)	1.1	1.4	1.7	1.7	1.7	1.5	1.2	
			Slot 	1	≤ 1	49	RPM	1497	749	499	374	299	250	187
						(39-59)	Fz	0.0002	0.0005	0.0009	0.0012	0.0015	0.0016	0.0017
						Feed (ipm)	0.9	1.1	1.3	1.3	1.3	1.2	1.0	
TITANIUM ALLOYS Pure Titanium, Ti6Al4V, Ti6Al2Sn4Zr2Mo, Ti4Al4Mo2Sn0.5Si	≤ 350 Bhn or ≤ 38 HRc	Profile 	≤ 0.5	≤ 1.5	215	RPM	6570	3285	2190	1643	1314	1095	821	
					(172-258)	Fz	0.0003	0.0008	0.0015	0.0020	0.0025	0.0026	0.0028	
					Feed (ipm)	5.9	7.9	9.9	9.9	9.9	8.5	6.9		
		Slot 	1	≤ 1	170	RPM	5195	2598	1732	1299	1039	866	649	
					(136-204)	Fz	0.0003	0.0008	0.0015	0.0020	0.0025	0.0026	0.0028	
					Feed (ipm)	4.7	6.2	7.8	7.8	7.8	6.8	5.5		
TITANIUM ALLOYS (DIFFICULT) Ti10Al2Fe3Al, Ti5Al5V5Mo3Cr, Ti7Al4Mo, Ti3Al8V6Cr4Zr4Mo, Ti6Al6V6Sn, Ti15V3 Cr3Sn3Al	≤ 440 Bhn or ≤ 47 HRc	Profile 	≤ 0.5	≤ 1.5	75	RPM	2292	1146	764	573	458	382	287	
					(60-90)	Fz	0.0003	0.0008	0.0015	0.0020	0.0025	0.0026	0.0028	
					Feed (ipm)	2.1	2.8	3.4	3.4	3.4	3.0	2.4		
		Slot 	1	≤ 1	60	RPM	1834	917	611	458	367	306	229	
					(48-72)	Fz	0.0003	0.0008	0.0015	0.0020	0.0025	0.0026	0.0028	
					Feed (ipm)	1.7	2.2	2.8	2.8	2.8	2.4	1.9		

Bhn (Brinell) HRc (Rockwell C)

rpm = Vc x 3.82 / D₁

ipm = Fz x 3 x rpm

reduce speed and feed for materials harder than listed

reduce feed and Ae when finish milling (.02 x D₁ maximum)

refer to the KYOCERA SGS Tool Wizard® for complete technical information (www.kyocera-sgstool.com)

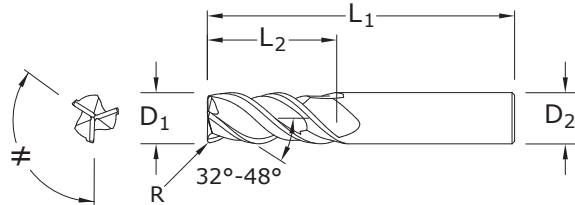

TOLERANCES (mm)

3-6 DIAMETER

$D_1 = +0,000/-0,030$

$D_2 = h_6$

$R = +0,000/-0,050$

>6-10 DIAMETER

$D_1 = +0,000/-0,040$

$D_2 = h_6$

$R = +0,000/-0,050$

>10-20 DIAMETER

$D_1 = +0,000/-0,050$

$D_2 = h_6$

$R = +0,000/-0,050$

STEELS

STAINLESS STEELS

CAST IRON

HIGH TEMP ALLOYS

TITANIUM

HARDENED STEELS

For patent information visit www.ksptpatents.com

mm					EDP NO.
CUTTING DIAMETER D_1	LENGTH OF CUT L_2	OVERALL LENGTH L_1	SHANK DIAMETER D_2	CORNER RADIUS R	TI-NAMITE-A (AITiN)
3,0	9,0	57,0	6,0	0,3	43445
3,0	9,0	57,0	6,0	0,5	43470
4,0	12,0	57,0	6,0	0,3	43446
4,0	12,0	57,0	6,0	0,5	43471
5,0	15,0	57,0	6,0	0,3	43447
5,0	15,0	57,0	6,0	0,5	43472
6,0	18,0	57,0	6,0	0,5	43448
6,0	18,0	57,0	6,0	1,0	43473
6,0	18,0	57,0	6,0	1,5	43474
6,0	18,0	57,0	6,0	2,0	43475
8,0	20,0	63,0	8,0	0,5	43449
8,0	20,0	63,0	8,0	1,0	43476
8,0	20,0	63,0	8,0	1,5	43477
8,0	20,0	63,0	8,0	2,0	43478
10,0	27,0	72,0	10,0	0,5	43450
10,0	27,0	72,0	10,0	1,0	43479
10,0	27,0	72,0	10,0	1,5	43480
10,0	27,0	72,0	10,0	2,0	43481
10,0	27,0	72,0	10,0	2,5	43482
12,0	30,0	83,0	12,0	0,5	43451
12,0	30,0	83,0	12,0	1,0	43483
12,0	30,0	83,0	12,0	1,5	43484
12,0	30,0	83,0	12,0	2,0	43485
12,0	30,0	83,0	12,0	2,5	43486
12,0	30,0	83,0	12,0	3,0	43487
12,0	30,0	83,0	12,0	4,0	43488
16,0	38,0	92,0	16,0	1,0	43452
16,0	38,0	92,0	16,0	1,5	43489
16,0	38,0	92,0	16,0	2,0	43490
16,0	38,0	92,0	16,0	2,5	43491
16,0	38,0	92,0	16,0	3,0	43492
16,0	38,0	92,0	16,0	4,0	43493
20,0	46,0	104,0	20,0	1,0	43453
20,0	46,0	104,0	20,0	2,0	43494
20,0	46,0	104,0	20,0	2,5	43495
20,0	46,0	104,0	20,0	3,0	43496
20,0	46,0	104,0	20,0	4,0	43497

33MCR
METRIC SERIES

- Specially engineered step core design provides stability for aggressive ramping and rigidity when flutes are completely engaged
- Open design at axial end accommodates material flow and load reduction during machining operations
- Enhanced corner geometry with tight tolerance corner radii
- Recommended for materials ≤ 45 HRc (≤ 420 Bhn)

Series 33

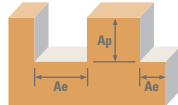

Series 33/MCR	Metric	Hardness	Ae x D ₁	Ap x D ₁	Vc (m/min)	Diameter (D ₁) (mm)								
						3	6	8	10	12	16	20		
P	CARBON STEELS 1018, 1040, 1080, 1090, 10L50, 1140, 1212, 12L15, 1525, 1536	≤ 275 Bhn or ≤ 28 HRc	Profile 	≤ 0.5	≤ 1.5	168	RPM	17773	8886	6665	5332	4443	3332	2666
						(134-201)	Fz	0.012	0.029	0.049	0.061	0.074	0.100	0.107
						Feed (mm/min)	640	768	981	981	992	998	853	
						134	RPM	14218	7109	5332	4265	3555	2666	2133
						(107-161)	Fz	0.012	0.029	0.049	0.061	0.074	0.100	0.107
						Feed (mm/min)	512	614	785	785	793	798	682	
	ALLOY STEELS 4140, 4150, 4320, 5120, 5150, 8630, 86L20, 50100	≤ 375 Bhn or ≤ 40 HRc	Profile 	≤ 0.5	≤ 1.5	96	RPM	10179	5089	3817	3054	2545	1909	1527
						(77-115)	Fz	0.010	0.022	0.036	0.045	0.055	0.074	0.080
						Feed (mm/min)	293	330	415	415	421	425	366	
						76	RPM	8078	4039	3029	2424	2020	1515	1212
						(61-91)	Fz	0.010	0.022	0.036	0.045	0.055	0.074	0.080
						Feed (mm/min)	233	262	330	330	334	337	291	
H	TOOL STEELS A2, D2, H13, L2, M2, P20, S7, T15, W2	≤ 375 Bhn or ≤ 40 HRc	Profile 	≤ 0.5	≤ 1.5	56	RPM	5978	2989	2242	1793	1495	1121	897
						(45-68)	Fz	0.007	0.017	0.030	0.037	0.043	0.059	0.064
						Feed (mm/min)	129	151	201	201	194	198	172	
						44	RPM	4686	2343	1757	1406	1171	879	703
						(35-53)	Fz	0.007	0.017	0.030	0.037	0.043	0.059	0.064
						Feed (mm/min)	101	118	157	157	152	155	135	
K	CAST IRONS (LOW & MEDIUM ALLOY) Gray, Malleable, Ductile	≤ 220 Bhn or ≤ 19 HRc	Profile 	≤ 0.5	≤ 1.5	136	RPM	14380	7190	5392	4314	3595	2696	2157
						(109-163)	Fz	0.008	0.026	0.045	0.056	0.067	0.090	0.096
						Feed (mm/min)	362	569	725	725	725	725	621	
						108	RPM	11471	5736	4302	3441	2868	2151	1721
						(87-130)	Fz	0.008	0.026	0.045	0.056	0.067	0.090	0.096
						Feed (mm/min)	289	454	578	578	578	578	496	
	CAST IRONS (HIGH ALLOY) Gray, Malleable, Ductile	≤ 260 Bhn or ≤ 26 HRc	Profile 	≤ 0.5	≤ 1.5	104	RPM	10987	5493	4120	3296	2747	2060	1648
						(83-124)	Fz	0.007	0.019	0.034	0.043	0.050	0.067	0.072
						Feed (mm/min)	237	316	422	422	415	411	356	
						82	RPM	8725	4362	3272	2617	2181	1636	1309
						(66-99)	Fz	0.007	0.019	0.034	0.043	0.050	0.067	0.072
						Feed (mm/min)	188	251	335	335	330	327	283	
M	STAINLESS STEELS (FREE MACHINING) 303, 416, 420F, 430F, 440F	≤ 275 Bhn or ≤ 28 HRc	Profile 	≤ 0.5	≤ 1.5	149	RPM	15834	7917	5938	4750	3958	2969	2375
						(119-179)	Fz	0.009	0.024	0.041	0.051	0.060	0.079	0.085
						Feed (mm/min)	433	570	722	722	712	707	608	
						119	RPM	12602	6301	4726	3781	3151	2363	1890
						(95-143)	Fz	0.009	0.024	0.041	0.051	0.060	0.079	0.085
						Feed (mm/min)	345	454	575	575	567	563	484	

continued on next page

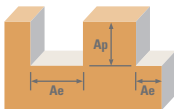

Series 33MCR Metric	Hardness	Ae x D ₁	Ap x D ₁	Vc (m/min)	Diameter (D ₁) (mm)								
					3	6	8	10	12	16	20		
M	STAINLESS STEELS (DIFFICULT) 304, 304L, 316, 316L	Profile 	≤ 0.5	≤ 1.5	104	RPM	10987	5493	4120	3296	2747	2060	1648
					(83-124)	Fz	0.007	0.019	0.032	0.040	0.048	0.064	0.069
					Feed (mm/min)	237	316	396	396	395	396	343	
		Slot 	1	≤ 1	82	RPM	8725	4362	3272	2617	2181	1636	1309
					(66-99)	Fz	0.007	0.019	0.032	0.040	0.048	0.064	0.069
					Feed (mm/min)	188	251	314	314	314	314	272	
	STAINLESS STEELS (PH) 13-8 PH, 15-5 PH, 17-4 PH, Custom 450	Profile 	≤ 0.5	≤ 1.5	94	RPM	10017	5009	3756	3005	2504	1878	1503
					(76-113)	Fz	0.007	0.019	0.032	0.040	0.048	0.064	0.069
					Feed (mm/min)	216	288	361	361	361	361	313	
		Slot 	1	≤ 1	76	RPM	8078	4039	3029	2424	2020	1515	1212
					(61-91)	Fz	0.007	0.019	0.032	0.040	0.048	0.064	0.069
					Feed (mm/min)	174	233	291	291	291	291	252	
S	SUPER ALLOYS (NICKEL, COBALT, IRON BASE) Inconel 601, 617, 625, Incoloy, Monel 400	Profile 	≤ 0.5	≤ 1.5	24	RPM	2585	1293	969	776	646	485	388
					(20-29)	Fz	0.006	0.017	0.028	0.035	0.041	0.054	0.059
					Feed (mm/min)	48	65	81	65	79	78	68	
		Slot 	1	≤ 1	20	RPM	2100	1050	788	630	525	394	315
					(16-24)	Fz	0.006	0.017	0.028	0.035	0.041	0.054	0.059
					Feed (mm/min)	39	53	66	66	64	64	55	
	SUPER ALLOYS (NICKEL, COBALT, IRON BASE) Inconel 718, X-750, Incoloy, Waspaloy, Hastelloy, Rene	Profile 	≤ 0.5	≤ 1.5	19	RPM	2003	1002	751	601	501	376	301
					(15-23)	Fz	0.005	0.012	0.019	0.024	0.029	0.038	0.043
					Feed (mm/min)	29	36	43	43	43	43	38	
		Slot 	1	≤ 1	15	RPM	1583	792	594	475	396	297	238
					(12-18)	Fz	0.005	0.012	0.019	0.024	0.029	0.038	0.043
					Feed (mm/min)	23	28	34	34	34	34	30	
TITANIUM ALLOYS Pure Titanium, Ti6Al4V, Ti6Al2Sn4Zr2Mo, Ti4Al4Mo2Sn0.5Si	Profile 	≤ 0.5	≤ 1.5	66	RPM	6947	3474	2605	2084	1737	1303	1042	
				(52-79)	Fz	0.007	0.019	0.032	0.040	0.048	0.064	0.069	
				Feed (mm/min)	150	200	250	250	250	250	217		
	Slot 	1	≤ 1	52	RPM	5493	2747	2060	1648	1373	1030	824	
				(41-62)	Fz	0.007	0.019	0.032	0.040	0.048	0.064	0.069	
				Feed (mm/min)	119	158	198	198	198	198	171		
TITANIUM ALLOYS (DIFFICULT) Ti10Al2Fe3Al, Ti5Al5V5Mo3Cr, Ti7Al4Mo, Ti3Al8V6Cr4Zr4Mo, Ti6Al6V6Sn, Ti15V3 Cr3Sn3Al	Profile 	≤ 0.5	≤ 1.5	23	RPM	2424	1212	909	727	606	454	364	
				(18-27)	Fz	0.007	0.019	0.032	0.040	0.048	0.064	0.069	
				Feed (mm/min)	52	70	87	87	87	87	76		
	Slot 	1	≤ 1	18	RPM	1939	969	727	582	485	364	291	
				(15-22)	Fz	0.007	0.019	0.032	0.040	0.048	0.064	0.069	
				Feed (mm/min)	42	56	70	70	70	70	60		

Bhn (Brinell) HRc (Rockwell C)
 $rpm = (Vc \times 1000) / (D_1 \times 3.14)$
 $mm/min = Fz \times 3 \times rpm$
 reduce speed and feed for materials harder than listed
 reduce feed and Ae when finish milling (.02 x D₁ maximum)
 refer to the KYOCERA SGS Tool Wizard® for complete technical information (www.kyocera-sgstool.com)

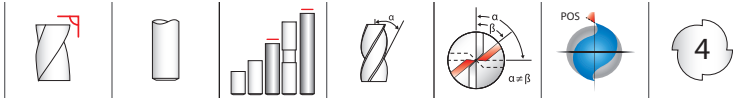

7
FRACTIONAL SERIES

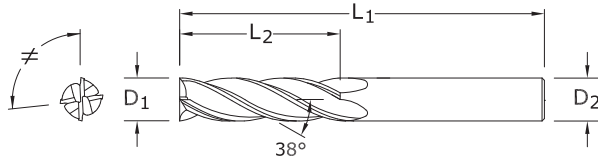

- Variable pitch allows for improved chatter suppression along with improved surface finish and enhanced tool life
- Raised land and increased core diameter designed to enhance tool life and decrease tool deflection
- Recommended for materials ≤ 45 HRc (≤ 420 Bhn)

CUTTING DIAMETER D_1	inch			SHANK DIAMETER D_2	EDP NO. Ti-NAMITE-X
	LENGTH OF CUT L_2	OVERALL LENGTH L_1			
1/8	3/4	2-1/4		1/8	70470
1/8	1	3		1/8	70471
3/16	3/4	2-1/2		3/16	70472
3/16	1-1/8	3		3/16	70473
1/4	1-1/8	3		1/4	70474
1/4	1-1/2	4		1/4	70475
5/16	1-1/8	3		5/16	70476
5/16	1-5/8	4		5/16	70477
3/8	1-1/8	3		3/8	70478
3/8	1-3/4	4		3/8	70479
7/16	2	4-1/2		7/16	70480
7/16	3	6		7/16	70481
1/2	2	4-1/2		1/2	70482
1/2	3	6		1/2	70483
5/8	2-1/4	5		5/8	70484
5/8	3	6		5/8	70485
3/4	2-1/4	5		3/4	70486
3/4	3	6		3/4	70487
1	2-1/4	5		1	70488
1	3	6		1	70489

TOLERANCES (inch)

$D_1 = +0.0000/-0.0020$

$D_2 = h_6$

- STEELS
- STAINLESS STEELS
- CAST IRON
- HIGH TEMP ALLOYS
- TITANIUM
- HARDENED STEELS

For patent information visit www.ksptpatents.com

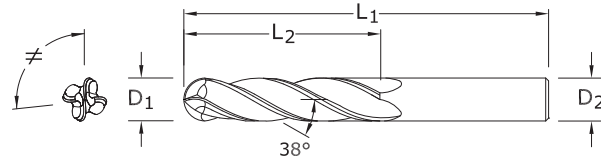
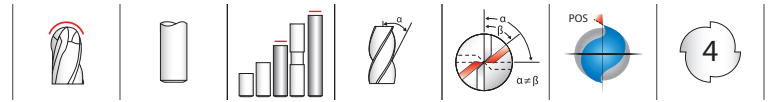

TOLERANCES (inch)

$D_1 = +0.0000/-0.0020$

$D_2 = h_6$

BALL RADIUS

$+0.0000/-0.0010$

- STEELS**
- STAINLESS STEELS**
- CAST IRON**
- HIGH TEMP ALLOYS**
- TITANIUM**
- HARDENED STEELS**

For patent information visit www.ksptpatents.com

inch				EDP NO.
CUTTING DIAMETER D_1	LENGTH OF CUT L_2	OVERALL LENGTH L_1	SHANK DIAMETER D_2	Ti-NAMITE-X
1/8	3/4	2-1/4	1/8	70441
1/8	1	3	1/8	70442
3/16	3/4	2-1/2	3/16	70444
3/16	1-1/8	3	3/16	70445
1/4	1-1/8	3	1/4	70447
1/4	1-1/2	4	1/4	70448
5/16	1-1/8	3	5/16	70450
5/16	1-5/8	4	5/16	70451
3/8	1-1/8	3	3/8	70453
3/8	1-3/4	4	3/8	70454
7/16	2	4-1/2	7/16	70456
7/16	3	6	7/16	70457
1/2	2	4-1/2	1/2	70459
1/2	3	6	1/2	70460
5/8	2-1/4	5	5/8	70462
5/8	3	6	5/8	70463
3/4	2-1/4	5	3/4	70465
3/4	3	6	3/4	70466
1	2-1/4	5	1	70468
1	3	6	1	70469

7B
FRACTIONAL SERIES

- Variable pitch allows for improved chatter suppression along with improved surface finish and enhanced tool life
- Raised land and increased core diameter designed to enhance tool life and decrease tool deflection
- Ball nose design ideal for finishing operations in complex workpieces
- Recommended for materials ≤ 45 HRc (≤ 420 Bhn)

FRACTIONAL Series 7

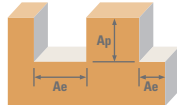

Series 7, 7B Fractional	Hardness	Finish	Ae x D ₁	Ap x D ₁	Vc (sfm)	Diameter (D ₁) (inch)								
						1/8	1/4	3/8	1/2	5/8	3/4	1		
P	CARBON STEELS 1018, 1040, 1080, 1090, 10L50, 1140, 1212, 12L15, 1525, 1536	≤ 275 Bhn or ≤ 28 HRc	Finish	≤ 0.02	≤ 2	480	RPM	14669	7334	4890	3667	2934	2445	1834
						(384-576)	Fz	0.0004	0.0010	0.0019	0.0025	0.0032	0.0033	0.0035
						Feed (ipm)	23.5	29.3	37.2	36.7	37.6	32.3	25.7	
P	ALLOY STEELS 4140, 4150, 4320, 5120, 5150, 8630, 86L20, 50100	≤ 375 Bhn or ≤ 40 HRc	Finish	≤ 0.02	≤ 2	275	RPM	8404	4202	2801	2101	1681	1401	1051
						(220-330)	Fz	0.0003	0.0007	0.0014	0.0018	0.0023	0.0024	0.0026
						Feed (ipm)	10.1	11.8	15.7	15.1	15.5	13.4	10.9	
H	TOOL STEELS A2, D2, H13, L2, M2, P20, S7, T15, W2	≤ 375 Bhn or ≤ 40 HRc	Finish	≤ 0.02	≤ 2	230	RPM	7029	3514	2343	1757	1406	1171	879
						(184-276)	Fz	0.0002	0.0006	0.0012	0.0016	0.0020	0.0021	0.0022
						Feed (ipm)	5.6	8.4	11.2	11.2	11.2	9.8	7.7	
K	CAST IRONS (LOW & MEDIUM ALLOY) Gray, Malleable, Ductile	≤ 220 Bhn or ≤ 19 HRc	Finish	≤ 0.02	≤ 2	605	RPM	18489	9244	6163	4622	3698	3081	2311
						(484-726)	Fz	0.0006	0.0015	0.0028	0.0037	0.0046	0.0047	0.0051
						Feed (ipm)	44.4	55.5	69.0	68.4	68.0	57.9	47.1	
K	CAST IRONS (HIGH ALLOY) Gray, Malleable, Ductile	≤ 260 Bhn or ≤ 26 HRc	Finish	≤ 0.02	≤ 2	465	RPM	14210	7105	4737	3553	2842	2368	1776
						(372-558)	Fz	0.0004	0.0011	0.0021	0.0028	0.0034	0.0036	0.0039
						Feed (ipm)	22.7	31.3	39.8	39.8	38.7	34.1	27.7	
M	STAINLESS STEELS (FREE MACHINING) 303, 416, 420F, 430F, 440F	≤ 275 Bhn or ≤ 28 HRc	Finish	≤ 0.02	≤ 2	420	RPM	12835	6418	4278	3209	2567	2139	1604
						(336-504)	Fz	0.0004	0.0010	0.0019	0.0025	0.0032	0.0033	0.0035
						Feed (ipm)	20.5	25.7	32.5	32.1	32.9	28.2	22.5	
M	STAINLESS STEELS (DIFFICULT) 304, 304L, 316, 316L	≤ 275 Bhn or ≤ 28 HRc	Finish	≤ 0.02	≤ 2	290	RPM	8862	4431	2954	2216	1772	1477	1108
						(232-348)	Fz	0.0003	0.0007	0.0014	0.0018	0.0023	0.0024	0.0026
						Feed (ipm)	10.6	12.4	16.5	16.0	16.3	14.2	11.5	
M	STAINLESS STEELS (PH) 13-8 PH, 15-5 PH, 17-4 PH, Custom 450	≤ 325 Bhn or ≤ 35 HRc	Finish	≤ 0.02	≤ 2	265	RPM	8098	4049	2699	2025	1620	1350	1012
						(212-318)	Fz	0.0003	0.0007	0.0014	0.0018	0.0023	0.0024	0.0026
						Feed (ipm)	9.7	11.3	15.1	14.6	14.9	13.0	10.5	
S	SUPER ALLOYS (NICKEL, COBALT, IRON BASE) Inconel 601, 617, 625, Incoloy, Monel 400	≤ 300 Bhn or ≤ 32 HRc	Finish	≤ 0.02	≤ 2	80	RPM	2445	1222	815	611	489	407	306
						(64-96)	Fz	0.0003	0.0007	0.0014	0.0018	0.0023	0.0024	0.0026
						Feed (ipm)	2.9	3.4	4.6	4.4	4.5	3.9	3.2	
S	SUPER ALLOYS (NICKEL, COBALT, IRON BASE) Inconel 718, X-750, Incoloy, Waspaloy, Hastelloy, Rene	≤ 400 Bhn or ≤ 43 HRc	Finish	≤ 0.02	≤ 2	65	RPM	1986	993	662	497	397	331	248
						(52-78)	Fz	0.0002	0.0006	0.0010	0.0014	0.0017	0.0018	0.0019
						Feed (ipm)	1.6	2.4	2.6	2.8	2.7	2.4	1.9	
S	TITANIUM ALLOYS Pure Titanium, Ti6Al4V, Ti6Al2Sn4Zr2Mo, Ti4Al4Mo2Sn0.5Si	≤ 350 Bhn or ≤ 38 HRc	Finish	≤ 0.02	≤ 2	300	RPM	9168	4584	3056	2292	1834	1528	1146
						(240-360)	Fz	0.0004	0.0011	0.0021	0.0028	0.0034	0.0036	0.0039
						Feed (ipm)	14.7	20.2	25.7	25.7	24.9	22.0	17.9	
S	TITANIUM ALLOYS (DIFFICULT) Ti10Al2Fe3Al, Ti5Al5V5Mo3Cr, Ti7Al4Mo, Ti3Al8V6Cr4Zr4Mo, Ti6Al6V6Sn, Ti15V3 Cr3Sn3Al	≤ 440 Bhn or ≤ 47 HRc	Finish	≤ 0.02	≤ 2	105	RPM	3209	1604	1070	802	642	535	401
						(84-126)	Fz	0.0004	0.0011	0.0021	0.0028	0.0034	0.0036	0.0039
						Feed (ipm)	5.1	7.1	9.0	9.0	8.7	7.7	6.3	

Bhn (Brinell) HRc (Rockwell C)

rpm = Vc x 3.82 / D₁

ipm = Fz x 4 x rpm

reduce speed and feed for materials harder than listed

refer to the KYOCERA SGS Tool Wizard® for complete technical information (www.kyocera-sgstool.com)

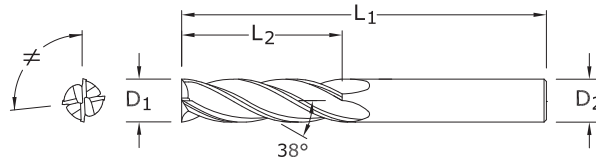
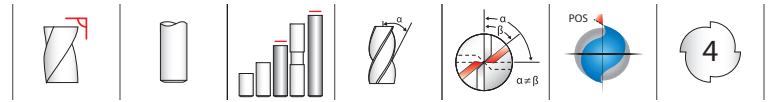

TOLERANCES (mm)

$D_1 = +0,000/+0,050$

$D_2 = h_6$

- STEELS
- STAINLESS STEELS
- CAST IRON
- HIGH TEMP ALLOYS
- TITANIUM
- HARDENED STEELS

For patent information visit www.ksptpatents.com

7M
METRIC SERIES

mm				EDP NO.
CUTTING DIAMETER D_1	LENGTH OF CUT L_2	OVERALL LENGTH L_1	SHANK DIAMETER D_2	Ti-NAMITE-X
3,0	25,0	75,0	3,0	70551
4,0	25,0	75,0	4,0	70552
5,0	25,0	75,0	5,0	70553
6,0	25,0	75,0	6,0	70554
8,0	25,0	75,0	8,0	70555
10,0	38,0	100,0	10,0	70556
12,0	50,0	100,0	12,0	70557
12,0	75,0	150,0	12,0	70558
14,0	75,0	150,0	14,0	70559
16,0	75,0	150,0	16,0	70560
18,0	75,0	150,0	18,0	70561
20,0	75,0	150,0	20,0	70562
25,0	75,0	150,0	25,0	70563

- Variable pitch allows for improved chatter suppression along with improved surface finish and enhanced tool life
- Raised land and increased core diameter designed to enhance tool life and decrease tool deflection
- Recommended for materials ≤ 45 HRc (≤ 420 Bhn)

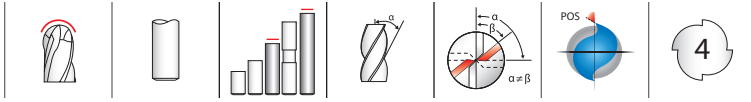

7MB
METRIC SERIES

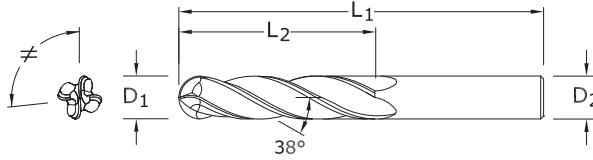

- Variable pitch allows for improved chatter suppression along with improved surface finish and enhanced tool life
- Raised land and increased core diameter designed to enhance tool life and decrease tool deflection
- Ball nose design ideal for finishing operations in complex workpieces
- Recommended for materials ≤ 45 HRc (≤ 420 Bhn)

mm				EDP NO.
CUTTING DIAMETER D_1	LENGTH OF CUT L_2	OVERALL LENGTH L_1	SHANK DIAMETER D_2	Ti-NAMITE-X
3,0	25,0	75,0	3,0	70527
4,0	25,0	75,0	4,0	70529
5,0	25,0	75,0	5,0	70531
6,0	25,0	75,0	6,0	70533
8,0	25,0	75,0	8,0	70535
10,0	38,0	100,0	10,0	70537
12,0	50,0	100,0	12,0	70539
12,0	75,0	150,0	12,0	70540
14,0	75,0	150,0	14,0	70542
16,0	75,0	150,0	16,0	70544
18,0	75,0	150,0	18,0	70546
20,0	75,0	150,0	20,0	70548
25,0	75,0	150,0	25,0	70550

TOLERANCES (mm)

$D_1 = +0,000/+0,050$

$D_2 = h_6$

BALL RADIUS

$+0,000/-0,025$

- STEELS
- STAINLESS STEELS
- CAST IRON
- HIGH TEMP ALLOYS
- TITANIUM
- HARDENED STEELS

For patent information visit www.ksptpatents.com

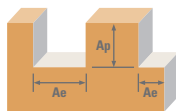

Series 7M, 7MB Metric	Hardness	Finish	Ae x D ₁	Ap x D ₁	Vc (m/min)	Diameter (D ₁) (mm)								
						3	6	8	10	12	16	20	25	
P CARBON STEELS 1018, 1040, 1080, 1090, 10L50, 1140, 1212, 12L15, 1525, 1536	≤ 275 Bhn or ≤ 28 HRc	Finish	≤ 0.02	≤ 2	146	RPM	15511	7755	5816	4653	3878	2908	2327	1861
					(117-176)	Fz	0.0166	0.043	0.075	0.093	0.110	0.125	0.147	0.160
					Feed (mm/min)	1030	1334	1745	1731	1706	1454	1368	1191	
ALLOY STEELS 4140, 4150, 4320, 5120, 5150, 8630, 86L20, 50100	≤ 375 Bhn or ≤ 40 HRc	Finish	≤ 0.02	≤ 2	84	RPM	8886	4443	3332	2666	2222	1666	1333	1066
					(67-101)	Fz	0.0122	0.034	0.051	0.069	0.082	0.091	0.109	0.120
					Feed (mm/min)	434	604	680	736	729	606	581	512	
H TOOL STEELS A2, D2, H13, L2, M2, P20, S7, T15, W2	≤ 375 Bhn or ≤ 40 HRc	Finish	≤ 0.02	≤ 2	70	RPM	7432	3716	2787	2230	1858	1394	1115	892
					(56-84)	Fz	0.0070	0.019	0.040	0.043	0.048	0.057	0.064	0.070
					Feed (mm/min)	208	282	446	384	357	318	285	250	
K CAST IRONS (LOW & MEDIUM ALLOY) Gray, Malleable, Ductile	≤ 220 Bhn or ≤ 19 HRc	Finish	≤ 0.02	≤ 2	184	RPM	19550	9775	7331	5865	4887	3666	2932	2346
					(148-221)	Fz	0.0132	0.036	0.052	0.075	0.089	0.099	0.117	0.130
					Feed (mm/min)	1032	1408	1525	1759	1740	1452	1372	1220	
CAST IRONS (HIGH ALLOY) Gray, Malleable, Ductile	≤ 260 Bhn or ≤ 26 HRc	Finish	≤ 0.02	≤ 2	142	RPM	15026	7513	5635	4508	3756	2817	2254	1803
					(113-170)	Fz	0.0132	0.036	0.052	0.075	0.089	0.099	0.117	0.130
					Feed (mm/min)	793	1082	1172	1352	1337	1116	1055	938	
M STAINLESS STEELS (FREE MACHINING) 303, 416, 420F, 430F, 440F	≤ 275 Bhn or ≤ 28 HRc	Finish	≤ 0.02	≤ 2	128	RPM	13572	6786	5089	4072	3393	2545	2036	1629
					(102-154)	Fz	0.0086	0.024	0.040	0.048	0.058	0.065	0.077	0.087
					Feed (mm/min)	467	651	814	782	787	662	627	567	
STAINLESS STEELS (DIFFICULT) 304, 304L, 316, 316L	≤ 275 Bhn or ≤ 28 HRc	Finish	≤ 0.02	≤ 2	88	RPM	9371	4686	3514	2811	2343	1757	1406	1125
					(71-106)	Fz	0.0082	0.022	0.037	0.045	0.048	0.060	0.072	0.078
					Feed (mm/min)	307	412	520	506	450	422	405	351	
STAINLESS STEELS (PH) 13-8 PH, 15-5 PH, 17-4 PH, Custom 450	≤ 325 Bhn or ≤ 35 HRc	Finish	≤ 0.02	≤ 2	81	RPM	8563	4282	3211	2569	2141	1606	1284	1028
					(65-97)	Fz	0.0070	0.019	0.029	0.040	0.048	0.055	0.064	0.070
					Feed (mm/min)	240	325	372	411	411	353	329	288	
S SUPER ALLOYS (NICKEL, COBALT, IRON BASE) Inconel 601, 617, 625, Incoloy, Monel 400	≤ 300 Bhn or ≤ 32 HRc	Finish	≤ 0.02	≤ 2	24	RPM	2585	1293	969	776	646	485	388	310
					(20-29)	Fz	0.0072	0.019	0.029	0.037	0.046	0.053	0.061	0.085
					Feed (mm/min)	74	98	112	90	119	103	95	105	
SUPER ALLOYS (NICKEL, COBALT, IRON BASE) Inconel 718, X-750, Incoloy, Waspaloy, Hastelloy, Rene	≤ 400 Bhn or ≤ 43 HRc	Finish	≤ 0.02	≤ 2	20	RPM	2100	1050	788	630	525	394	315	252
					(16-24)	Fz	0.0075	0.016	0.021	0.030	0.038	0.044	0.051	0.070
					Feed (mm/min)	63	67	66	76	80	69	64	71	
TITANIUM ALLOYS Pure Titanium, Ti6Al4V, Ti6Al2Sn4Zr2Mo, Ti4Al4Mo2Sn0.5Si	≤ 350 Bhn or ≤ 38 HRc	Finish	≤ 0.02	≤ 2	91	RPM	9694	4847	3635	2908	2424	1818	1454	1163
					(73-110)	Fz	0.0091	0.024	0.004	0.005	0.060	0.070	0.080	0.088
					Feed (mm/min)	353	465	51	59	582	509	465	409	
TITANIUM ALLOYS (DIFFICULT) Ti10Al2Fe3Al, Ti5Al5V5Mo3Cr, Ti7Al4Mo, Ti3Al8V6Cr4Zr4Mo, Ti6Al6V6Sn, Ti15V3 Cr3Sn3Al	≤ 440 Bhn or ≤ 47 HRc	Finish	≤ 0.02	≤ 2	32	RPM	3393	1696	1272	1018	848	636	509	407
					(26-38)	Fz	0.0082	0.019	0.029	0.037	0.046	0.053	0.061	0.085
					Feed (mm/min)	111	129	148	151	156	135	124	138	

Bhn (Brinell) HRc (Rockwell C)
 $rpm = (Vc \times 1000) / (D_1 \times 3.14)$
 $mm/min = Fz \times 4 \times rpm$
 reduce speed and feed for materials harder than listed
 refer to the KYOCERA SGS Tool Wizard® for complete technical information (www.kyocera-sgstoool.com)



56B
FRACTIONAL SERIES

- Short flute length and rigid design to reduce deflection
- S-Gash Ball geometry minimizes load and heat produced during the cutting process, ultimately enhancing tool life
- Ideal for machining complex contoured shapes in hardened steels
- Recommended for materials 35 to 60 HRc (327 to 654 Bhn)

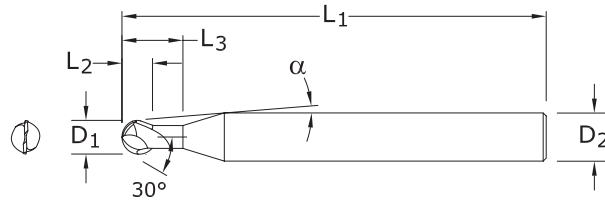

CUTTING DIAMETER D ₁	LENGTH OF CUT L ₂	inch				REACH L ₃	EDP NO. Ti-NAMITE-X
		OVERALL LENGTH L ₁	SHANK DIAMETER D ₂	α			
1/32	1/32	3	1/4	8°20'		1/16	93272
1/16	1/16	3	1/4	7°40'		1/8	93273
3/32	3/32	3	1/4	6°50'		3/16	93274
1/8	1/8	3	1/4	6°		1/4	93275
3/16	3/16	3	1/4	3°35'		3/8	93276
1/4	1/4	3-1/2	1/4	-		1/2	93277
5/16	5/16	4	5/16	-		5/8	93278
3/8	3/8	4	3/8	-		3/4	93279
1/2	1/2	4-1/2	1/2	-		1	93280
5/8	5/8	5-1/2	5/8	-		1-1/4	93281
3/4	3/4	6-1/2	3/4	-		1-1/2	93282

Neck Option Available

TOLERANCES (inch)

1/32–3/32 DIAMETER

D₁ = +0.0000/–0.0010

D₂ = h₆

BALL RADIUS

+0.0000/–0.0005

>3/32–1/4 DIAMETER

D₁ = +0.0000/–0.0012

D₂ = h₆

BALL RADIUS

+0.0000/–0.0006

>1/4–3/8 DIAMETER

D₁ = +0.0000/–0.0016

D₂ = h₆

BALL RADIUS

+0.0000/–0.0008

>3/8–3/4 DIAMETER

D₁ = +0.0000/–0.0020

D₂ = h₆

BALL RADIUS

+0.0000/–0.0010

HARDENED STEELS

For patent information visit
www.ksptpatents.com

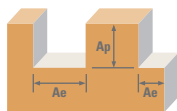

Series 56B	Fractional	Hardness	Ae x D ₁	Ap x D ₁	Vc (sfm)	Diameter (D ₁) (inch)								
						1/32	1/16	1/8	3/16	1/4	3/8	1/2	3/4	
H	TOOL STEELS MOLD AND DIE STEEL 300M, 4340, 52100, HP-9-4-20, M50, A2, D2, H13, L2, M2, P20, S7, T15, W2	Rough ≤ 375 Bhn or ≤ 40 HRc	≤ 0.4	≤ 0.1	625	RPM	76400	38200	19100	12733	9550	6367	4775	3183
					(500-750)	Fz	0.0006	0.0015	0.0030	0.0040	0.0050	0.0080	0.0100	0.0120
					Feed (ipm)	92	115	115	102	96	102	96	76	
		HSM ≤ 475 Bhn or ≤ 50 HRc	≤ 0.4	≤ 0.03	950	RPM	116128	58064	29032	19355	14516	9677	7258	4839
					(760-1140)	Fz	0.0007	0.0017	0.0033	0.0044	0.0060	0.0088	0.0110	0.0130
					Feed (ipm)	163	197	192	170	174	170	160	126	
	TOOL STEELS MOLD AND DIE STEEL 300M, 4340, 52100, HP-9-4-20, M50, A2, D2, H13, L2, M2, P20, S7, T15, W2	Rough ≤ 475 Bhn or ≤ 50 HRc	≤ 0.4	≤ 0.05	750	RPM	91680	45840	22920	15280	11460	7640	5730	3820
					(600-900)	Fz	0.0005	0.0011	0.0023	0.0030	0.0038	0.0060	0.0075	0.0085
					Feed (ipm)	92	101	105	92	87	92	86	65	
		HSM ≤ 655 Bhn or ≤ 60 HRc	≤ 0.4	≤ 0.02	1150	RPM	140576	70288	35144	23429	17572	11715	8786	5857
					(920-1380)	Fz	0.0006	0.0012	0.0025	0.0033	0.0042	0.0066	0.0082	0.0100
					Feed (ipm)	169	169	176	155	148	155	144	117	
TOOL STEELS MOLD AND DIE STEEL 300M, 4340, 52100, HP-9-4-20, M50, A2, D2, H13, L2, M2, P20, S7, T15, W2	Rough ≤ 655 Bhn or ≤ 60 HRc	≤ 0.4	≤ 0.04	500	RPM	61120	30560	15280	10187	7640	5093	3820	2547	
				(400-600)	Fz	0.0004	0.0008	0.0017	0.0023	0.0029	0.0045	0.0057	0.0063	
				Feed (ipm)	49	49	52	47	44	46	44	32		
	HSM ≤ 655 Bhn or ≤ 60 HRc	≤ 0.4	≤ 0.01	1000	RPM	122240	61120	30560	20373	15280	10187	7640	5093	
				(800-1200)	Fz	0.0005	0.0009	0.0019	0.0025	0.0032	0.0050	0.0063	0.0071	
				Feed (ipm)	122	110	116	102	98	102	96	72		

Bhn (Brinell) HRc (Rockwell C) HSM (High Speed Machining)
 $rpm = Vc \times 3.82 / D_1$
 $ipm = Fz \times 2 \times rpm$
 reduce speed and feed for materials harder than listed
 reduce feed and Ae when finish milling (.02 x D₁ maximum)
 refer to the KYOCERA SGS Tool Wizard® for complete technical information (www.kyocera-sgstool.com)

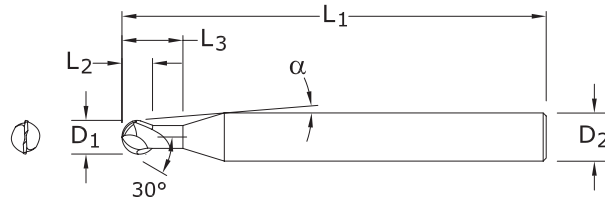

56MB
METRIC SERIES

- Short flute length and rigid design to reduce deflection
- S-Gash Ball geometry minimizes load and heat produced during the cutting process, ultimately enhancing tool life
- Ideal for machining complex contoured shapes in hardened steels
- Recommended for materials 35 to 60 HRc (327 to 654 Bhn)

mm						EDP NO.
CUTTING DIAMETER D ₁	LENGTH OF CUT L ₂	OVERALL LENGTH L ₁	SHANK DIAMETER D ₂	α	REACH L ₃	Ti-NAMITE-X
1,0	1,0	76,0	6,0	8°10'	2,0	91349
1,5	1,5	76,0	6,0	7°45'	3,0	91350
2,0	2,0	76,0	6,0	7°10'	4,0	91351
2,5	2,5	76,0	6,0	6°35'	5,0	91352
3,0	3,0	76,0	6,0	6°	6,0	91353
4,0	4,0	76,0	6,0	4°30'	8,0	91354
5,0	5,0	89,0	6,0	2°30'	10,0	91355
6,0	6,0	89,0	6,0	–	12,0	91356
8,0	8,0	102,0	8,0	–	16,0	91357
10,0	10,0	102,0	10,0	–	20,0	91358
12,0	12,0	114,0	12,0	–	24,0	91359
16,0	16,0	140,0	16,0	–	32,0	91360
20,0	20,0	165,0	20,0	–	40,0	91361

Neck Option Available

TOLERANCES (mm)

1–2,5 DIAMETER
D₁ = +0,000/–0,025
D₂ = h₆
BALL RADIUS
+0.0000/–0.0013

>2,5–6 DIAMETER
D₁ = +0,000/–0,030
D₂ = h₆
BALL RADIUS
+0.0000/–0.0015





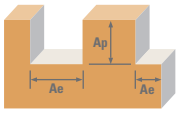

>6–10 DIAMETER
D₁ = +0,000/–0,040
D₂ = h₆
BALL RADIUS
+0.0000/–0.0020

>10–20 DIAMETER
D₁ = +0,000/–0,050
D₂ = h₆
BALL RADIUS
+0.0000/–0.0025

HARDENED STEELS

For patent information visit www.ksptpatents.com



Series 56MB Metric	Hardness	Ae x D ₁	Ap x D ₁	Vc (m/min)	Diameter (D ₁) (mm)										
					1	1.5	3	5	6	10	12	20			
TOOL STEELS MOLD AND DIE STEEL 300M, 4340, 52100, HP-9-4-20, M50, A2, D2, H13, L2, M2, P20, S7, T15, W2	≤ 375 Bhn or ≤ 40 HRc	Rough 	≤ 0.4	≤ 0.1	191	RPM	60748	40498	20249	12150	10125	6075	5062	3037	
					(153-229)	Fz	0.015	0.038	0.076	0.102	0.127	0.203	0.254	0.305	
					Feed (mm/min)	1822	3078	3078	2479	2572	2466	2572	1853		
		HSM 	≤ 0.4	≤ 0.03	290	RPM	92235	61490	46117	18447	15372	9223	7686	4612	
					(232-348)	Fz	0.018	0.043	0.084	0.112	0.117	0.224	0.279	0.330	
					Feed (mm/min)	3320	5288	7748	4132	3597	4132	4289	3044		
	TOOL STEELS MOLD AND DIE STEEL 300M, 4340, 52100, HP-9-4-20, M50, A2, D2, H13, L2, M2, P20, S7, T15, W2	≤ 475 Bhn or ≤ 50 HRc	Rough 	≤ 0.4	≤ 0.05	229	RPM	72833	48556	24278	14567	12139	7283	6069	3642
						(183-275)	Fz	0.013	0.028	0.058	0.076	0.097	0.152	0.191	0.216
						Feed (mm/min)	1894	2719	2816	2214	2355	2214	2319	1573	
			HSM 	≤ 0.4	≤ 0.02	351	RPM	111636	74424	37212	22327	18606	11164	9303	5582
						(281-421)	Fz	0.015	0.030	0.064	0.084	0.107	0.168	0.208	0.254
						Feed (mm/min)	3349	4465	4763	3751	3982	3751	3870	2836	
TOOL STEELS MOLD AND DIE STEEL 300M, 4340, 52100, HP-9-4-20, M50, A2, D2, H13, L2, M2, P20, S7, T15, W2		≤ 655 Bhn or ≤ 60 HRc	Rough 	≤ 0.4	≤ 0.04	152	RPM	48344	32229	16115	9669	8057	4834	4029	2417
						(122-182)	Fz	0.010	0.020	0.043	0.058	0.074	0.114	0.145	0.160
						Feed (mm/min)	967	1289	1386	1122	1192	1102	1168	773	
		HSM 	≤ 0.4	≤ 0.01	305	RPM	97005	64670	32335	19401	16168	9701	8084	4850	
					(244-366)	Fz	0.013	0.023	0.048	0.064	0.081	0.127	0.160	0.180	
					Feed (mm/min)	2522	2975	3104	2483	2619	2464	2587	1746		

Bhn (Brinell) HRc (Rockwell C) HSM (High Speed Machining)
 $rpm = (Vc \times 1000) / (D_1 \times 3.14)$
 $mm/min = Fz \times 2 \times rpm$
 reduce speed and feed for materials harder than listed
 reduce feed and Ae when finish milling (.02 x D₁ maximum)
 refer to the KYOCERA SGS Tool Wizard® for complete technical information (www.kyocera-sgstool.com)

FRACTIONAL Power-Carb

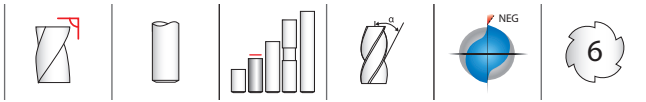

57

FRACTIONAL SERIES

- Ideal in Trochoidal milling applications in hardened steels and dry machining
- Short flute length and large core design to reduce deflection
- Unsurpassed edge strength with extreme negative rake and eccentric relief
- Recommended for materials 45 to 65 HRc (421 to 739 Bhn)

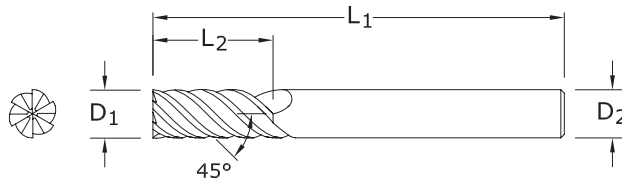

	inch			EDP NO.
CUTTING DIAMETER D ₁	LENGTH OF CUT L ₂	OVERALL LENGTH L ₁	SHANK DIAMETER D ₂	Ti-NAMITE-X
1/4	17/32	3-1/2	1/4	36140
5/16	11/16	4	5/16	36141
3/8	13/16	4	3/8	36142
1/2	1-3/32	4-1/2	1/2	36143

Neck Option Available

TOLERANCES (inch)

1/4 DIAMETER

D₁ = +0.0000/-0.0012

D₂ = h₆

5/16 DIAMETER

D₁ = +0.0000/-0.0016

D₂ = h₆

3/8 DIAMETER

D₁ = +0.0000/-0.0016

D₂ = h₆

1/2 DIAMETER

D₁ = +0.0000/-0.0020

D₂ = h₆

HARDENED STEELS

For patent information visit www.ksptpatents.com

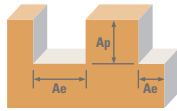

Series 57 Fractional	Hardness			Vc (sfm)	Diameter (D ₁) (inch)					
		Ae x D ₁	Ap x D ₁		1/4	5/16	3/8	1/2		
TOOL STEELS MOLD AND DIE STEEL 300M, 4340, 52100, HP-9-4-20, M50, A2, D2, H13, L2, M2, P20, S7, T15, W2	≤ 420 Bhn or ≤ 45 HRc	Slot 	1	≤ 0.3	215	RPM	3285	2628	2190	1643
					(172-258)	Fz	0.0013	0.0019	0.0025	0.0031
						Feed (ipm)	26	30	33	31
	Profile 	≤ 0.1	≤ 1.5	265	RPM	4049	3239	2699	2025	
				(212-318)	Fz	0.0018	0.0026	0.0035	0.0044	
					Feed (ipm)	44	51	57	53	
	HSM 	≤ 0.04	≤ 1.5	560	RPM	8557	6845	5705	4278	
				(448-672)	Fz	0.0022	0.0033	0.0044	0.0055	
					Feed (ipm)	113	136	151	141	
TOOL STEELS MOLD AND DIE STEEL 300M, 4340, 52100, HP-9-4-20, M50, A2, D2, H13, L2, M2, P20, S7, T15, W2	≤ 560 Bhn or ≤ 55 HRc	Slot 	1	≤ 0.3	120	RPM	1834	1467	1222	917
					(96-144)	Fz	0.0010	0.0015	0.0020	0.0025
						Feed (ipm)	11	13	15	14
	Profile 	≤ 0.1	≤ 1.5	150	RPM	2292	1834	1528	1146	
				(120-180)	Fz	0.0014	0.0021	0.0028	0.0035	
					Feed (ipm)	19	23	26	24	
	HSM 	≤ 0.04	≤ 1.5	490	RPM	7487	5990	4991	3744	
				(392-588)	Fz	0.0018	0.0026	0.0035	0.0044	
					Feed (ipm)	81	93	105	99	
TOOL STEELS MOLD AND DIE STEEL 300M, 4340, 52100, HP-9-4-20, M50, A2, D2, H13, L2, M2, P20, S7, T15, W2	≤ 740 Bhn or ≤ 65 HRc	Slot 	1	≤ 0.3	65	RPM	993	795	662	497
					(52-78)	Fz	0.0008	0.0011	0.0015	0.0019
						Feed (ipm)	5	5	6	6
	Profile 	≤ 0.1	≤ 1.5	80	RPM	1222	978	815	611	
				(64-96)	Fz	0.0011	0.0016	0.0021	0.0026	
					Feed (ipm)	8	9	10	10	
	HSM 	≤ 0.04	≤ 1.5	250	RPM	3820	3056	2547	1910	
				(200-300)	Fz	0.0013	0.0019	0.0025	0.0031	
					Feed (ipm)	30	35	38	36	

Bhn (Brinell) HRc (Rockwell C) HSM (High Speed Machining)
 $rpm = Vc \times 3.82 / D_1$
 $ipm = Fz \times 6 \times rpm$
 reduce speed and feed for materials harder than listed
 reduce feed and Ae when finish milling (.02 x D₁ maximum)
 refer to the KYOCERA SGS Tool Wizard® for complete technical information (www.kyocera-sgstool.com)

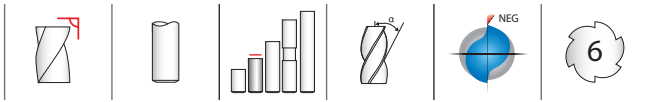

57M METRIC SERIES

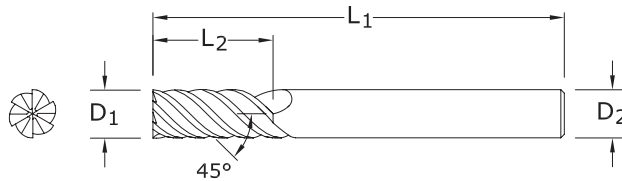

- Ideal in Trochoidal milling applications in hardened steels and dry machining
- Short flute length and large core design to reduce deflection
- Unsurpassed edge strength with extreme negative rake and eccentric relief
- Recommended for materials 45 to 65 HRc (421 to 739 Bhn)

mm				EDP NO.
CUTTING DIAMETER D ₁	LENGTH OF CUT L ₂	OVERALL LENGTH L ₁	SHANK DIAMETER D ₂	Ti-NAMITE-X
6,0	13,0	89,0	6,0	46140
8,0	18,0	102,0	8,0	46141
10,0	22,0	102,0	10,0	46142
12,0	26,0	114,0	12,0	46143
16,0	32,0	140,0	16,0	46145
20,0	38,0	165,0	20,0	46147

Neck Option Available

TOLERANCES (mm)

6 DIAMETER

D₁ = +0,000/-0,030
D₂ = h₆

8 DIAMETER

D₁ = +0,000/-0,040
D₂ = h₆

10 DIAMETER

D₁ = +0,000/-0,040
D₂ = h₆

12-20 DIAMETER

D₁ = +0,000/-0,050
D₂ = h₆

HARDENED STEELS

For patent information visit www.ksptpatents.com

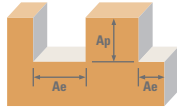

Series 57M Metric	Hardness	Ae x D ₁	Ap x D ₁	Vc (m/min)	Diameter (D ₁) (mm)							
					6	8	10	12	16	20		
TOOL STEELS MOLD AND DIE STEEL 300M, 4340, 52100, HP-9-4-20, M50, A2, D2, H13, L2, M2, P20, S7, T15, W2	≤ 420 Bhn or ≤ 45 HRc	Slot 	1	≤ 0.3	66	RPM	3499	2624	2099	1749	1312	1050
					(53-79)	Fz	0.032	0.048	0.064	0.079	0.094	0.109
					Feed (mm/min)	672	756	806	829	740	686	
	Profile 	≤ 0.1	≤ 1.5	81	RPM	4294	3220	2576	2147	1610	1288	
				(65-97)	Fz	0.046	0.066	0.089	0.112	0.132	0.152	
				Feed (mm/min)	1185	1275	1376	1443	1275	1175		
	HSM 	≤ 0.04	≤ 1.5	171	RPM	9064	6798	5439	4532	3399	2719	
				(137-205)	Fz	0.056	0.084	0.112	0.140	0.170	0.200	
				Feed (mm/min)	3046	3426	3655	3807	3467	3263		
TOOL STEELS MOLD AND DIE STEEL 300M, 4340, 52100, HP-9-4-20, M50, A2, D2, H13, L2, M2, P20, S7, T15, W2	≤ 560 Bhn or ≤ 55 HRc	Slot 	1	≤ 0.3	37	RPM	1961	1471	1177	981	735	588
					(30-44)	Fz	0.025	0.038	0.051	0.064	0.077	0.090
					Feed (mm/min)	294	335	360	377	340	318	
	Profile 	≤ 0.1	≤ 1.5	46	RPM	2438	1829	1463	1219	914	732	
				(37-55)	Fz	0.036	0.053	0.071	0.089	0.107	0.125	
				Feed (mm/min)	527	582	623	651	587	549		
	HSM 	≤ 0.04	≤ 1.5	149	RPM	7898	5924	4739	3949	2962	2369	
				(119-179)	Fz	0.046	0.066	0.089	0.112	0.135	0.158	
				Feed (mm/min)	2180	2346	2531	2654	2399	2246		
TOOL STEELS MOLD AND DIE STEEL 300M, 4340, 52100, HP-9-4-20, M50, A2, D2, H13, L2, M2, P20, S7, T15, W2	≤ 740 Bhn or ≤ 65 HRc	Slot 	1	≤ 0.3	20	RPM	1060	795	636	530	398	318
					(16-24)	Fz	0.020	0.028	0.038	0.048	0.058	0.068
					Feed (mm/min)	127	134	145	153	138	130	
	Profile 	≤ 0.1	≤ 1.5	24	RPM	1272	954	763	636	477	382	
				(19-29)	Fz	0.028	0.041	0.053	0.066	0.078	0.090	
				Feed (mm/min)	214	235	243	252	223	206		
	HSM 	≤ 0.04	≤ 1.5	76	RPM	4029	3021	2417	2014	1511	1209	
				(61-91)	Fz	0.033	0.048	0.064	0.079	0.094	0.109	
				Feed (mm/min)	798	870	928	955	852	790		

Bhn (Brinell) HRc (Rockwell C) HSM (High Speed Machining)
 rpm = (Vc x 1000) / (D₁ x 3.14)
 mm/min = Fz x 6 x rpm
 reduce speed and feed for materials harder than listed
 reduce feed and Ae when finish milling (.02 x D₁ maximum)
 refer to the KYOCERA SGS Tool Wizard® for complete technical information (www.kyocera-sgstool.com)

FRACTIONAL
Series 27

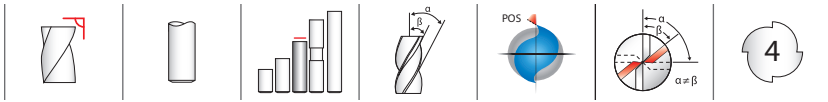

27
 FRACTIONAL SERIES

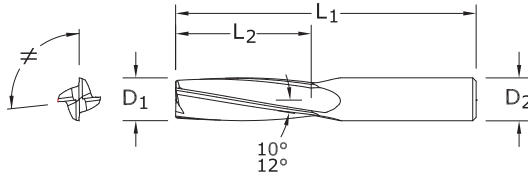

- Slow helix design adds strength to the edge allowing ease for milling highly abrasive materials
- Two levels of chatter suppression: variable helix and indexing
- Excels at roughing (slotting, profiling) and finishing in a variety of plastics and composites

CUTTING DIAMETER D ₁	LENGTH OF CUT L ₂	OVERALL LENGTH L ₁	SHANK DIAMETER D ₂	EDP NO.	
				UNCOATED	Di-NAMITE® (Diamond)
1/4	1	2-1/2	1/4	72978	72979
3/8	1-1/8	2-1/2	3/8	72980	72981
1/2	1-1/2	3-1/2	1/2	72982	72983
3/4	1-3/8	4	3/4	72984	72985

TOLERANCES (inch)

D₁ = +0.0000/-0.0030

D₂ = h₆

PLASTICS/COMPOSITES

For patent information visit www.ksptpatents.com

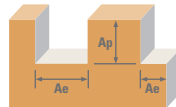

Series 27 Fractional	Ae x D ₁	Ap x D ₁	Vc (sfm)	Diameter (D ₁) (inch)					
				1/4	3/8	1/2	3/4		
CFRP, AFRP (CARBON FIBER, ARAMID FIBER)	Slot	1	≤ 1	400	RPM	6112	4075	3056	2037
				(320-480)	Fz	0.0016	0.0030	0.0040	0.0048
				Feed (ipm)	39	49	49	39	
	Profile	≤ 0.5	≤ 1.5	500	RPM	7640	5093	3820	2547
				(400-600)	Fz	0.0016	0.0030	0.0040	0.0048
				Feed (ipm)	49	61	61	49	
	HSM	≤ 0.5	≤ 2	825	RPM	12606	8404	6303	4202
				(660-990)	Fz	0.0037	0.0069	0.0092	0.0110
				Feed (ipm)	187	232	232	185	
GFRP (FIBERGLASS)	Slot	1	≤ 1	320	RPM	4890	3260	2445	1630
				(256-384)	Fz	0.0016	0.0030	0.0040	0.0048
				Feed (ipm)	31	39	39	31	
	Profile	≤ 0.5	≤ 1.5	400	RPM	6112	4075	3056	2037
				(320-480)	Fz	0.0016	0.0030	0.0040	0.0048
				Feed (ipm)	39	49	49	39	
	HSM	≤ 0.5	≤ 2	660	RPM	10085	6723	5042	3362
				(528-792)	Fz	0.0037	0.0069	0.0092	0.0110
				Feed (ipm)	149	186	186	148	
N CARBON, GRAPHITE	Slot	1	≤ 1	480	RPM	7334	4890	3667	2445
				(384-576)	Fz	0.0020	0.0038	0.0050	0.0060
				Feed (ipm)	59	74	73	59	
	Profile	≤ 0.5	≤ 1.5	600	RPM	9168	6112	4584	3056
				(480-720)	Fz	0.0020	0.0038	0.0050	0.0060
				Feed (ipm)	73	93	92	73	
	HSM	≤ 0.5	≤ 2	990	RPM	15127	10085	7564	5042
				(792-1188)	Fz	0.0046	0.0086	0.0115	0.0138
				Feed (ipm)	278	347	348	278	
PLASTICS	Slot	1	≤ 1	800	RPM	12224	8149	6112	4075
				(640-690)	Fz	0.0020	0.0038	0.0050	0.0060
				Feed (ipm)	98	124	122	98	
	Profile	≤ 0.5	≤ 1.5	1000	RPM	15280	10187	7640	5093
				(800-1200)	Fz	0.0020	0.0038	0.0050	0.0060
				Feed (ipm)	122	155	153	122	
	HSM	≤ 0.5	≤ 2	1650	RPM	25212	16808	12606	8404
				(1320-1980)	Fz	0.0046	0.0086	0.0115	0.0138
				Feed (ipm)	464	578	580	464	
MACHINABLE CERAMICS MACHINABLE GLASS	Slot	1	≤ 1	40	RPM	611	407	306	204
				(32-48)	Fz	0.0008	0.0015	0.0020	0.0024
				Feed (ipm)	2.0	2.4	2.4	2.0	
	Profile	≤ 0.5	≤ 1.5	50	RPM	764	509	382	255
				(40-60)	Fz	0.0008	0.0015	0.0020	0.0024
				Feed (ipm)	2.4	3.1	3.1	2.4	
	HSM	≤ 0.5	≤ 2	85	RPM	1299	866	649	433
				(68-102)	Fz	0.0018	0.0034	0.0046	0.0055
				Feed (ipm)	9.4	11.8	11.9	9.5	

HSM (High Speed Machining)
 $rpm = Vc \times 3.82 / D_1$
 $ipm = Fz \times 4 \times rpm$
 adjust parameters based on resin type and fiber structure
 reduce speed when overheating causes melting or damage to resin
 reduce feed if delamination or fraying occur
 finish cuts typically required reduced feed and cutting depths

rates shown are for use without coolant; rates may be increased with coolant
 dust collection is vital when machining dry
 diamond coating will increase tool life in graphite and composite materials
 refer to the KYOCERA SGS Tool Wizard® for complete technical information
 (www.kyocera-sgstool.com)

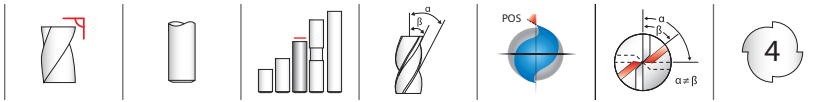

27M METRIC SERIES

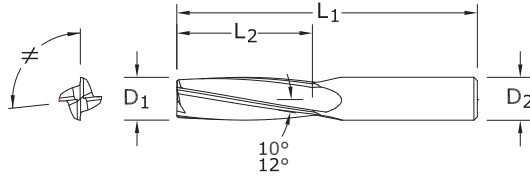

- Slow helix design adds strength to the edge allowing ease for milling highly abrasive materials
- Two levels of chatter suppression: variable helix and indexing
- Excels at roughing (slotting, profiling) and finishing in a variety of plastics and composites

CUTTING DIAMETER D ₁	LENGTH OF CUT L ₂	mm		EDP NO.	
		OVERALL LENGTH L ₁	SHANK DIAMETER D ₂	UNCOATED	Di-NAMITE® (Diamond)
6,0	25,0	63,0	6,0	83056	83057
8,0	25,0	63,0	8,0	83058	83059
10,0	28,0	63,0	10,0	83060	83061
12,0	38,0	89,0	12,0	83062	83063
16,0	48,0	115,0	16,0	83064	83065

TOLERANCES (mm)





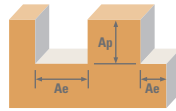

D₁ = +0,000/-0,080

D₂ = h₆

PLASTICS/COMPOSITES

For patent information visit www.ksptpatents.com



Series 27M Metric	Ae x D ₁	Ap x D ₁	Vc (m/min)	Diameter (D ₁) (mm)						
				6	8	10	12	16		
CFRP, AFRP (CARBON FIBER, ARAMID FIBER)	Slot 	1	≤ 1	120	RPM	6361	4771	3817	3181	2385
				(96-164)	Fz	0.040	0.065	0.075	0.100	0.120
				Feed (mm/min)	1018	1240	1145	1272	1145	
	Profile 	≤ 0.5	≤ 1.5	150	RPM	7951	5963	4771	3976	2982
				(120-180)	Fz	0.040	0.065	0.075	0.100	0.120
				Feed (mm/min)	1272	1550	1431	1590	1431	
	HSM 	≤ 0.5	≤ 2	250	RPM	13252	9939	7951	6626	4970
				(200-300)	Fz	0.095	0.145	0.175	0.235	0.280
				Feed (mm/min)	5036	5765	5566	6228	5566	
GFRP (FIBERGLASS)	Slot 	1	≤ 1	100	RPM	5301	3976	3181	2650	1988
				(80-120)	Fz	0.040	0.065	0.075	0.100	0.120
				Feed (mm/min)	848	1034	954	1060	954	
	Profile 	≤ 0.5	≤ 1.5	120	RPM	6361	4771	3817	3181	2385
				(96-164)	Fz	0.040	0.065	0.075	0.100	0.120
				Feed (mm/min)	1018	1240	1145	1272	1145	
	HSM 	≤ 0.5	≤ 2	200	RPM	10602	7951	6361	5301	3976
				(160-240)	Fz	0.095	0.145	0.175	0.235	0.280
				Feed (mm/min)	4029	4612	4453	4983	4453	
N CARBON, GRAPHITE	Slot 	1	≤ 1	145	RPM	7686	5765	4612	3843	2882
				(116-174)	Fz	0.050	0.080	0.095	0.125	0.150
				Feed (mm/min)	1537	1845	1752	1922	1729	
	Profile 	≤ 0.5	≤ 1.5	185	RPM	9807	7355	5884	4903	3677
				(148-222)	Fz	0.050	0.080	0.095	0.125	0.150
				Feed (mm/min)	1961	2354	2236	2452	2206	
	HSM 	≤ 0.5	≤ 2	300	RPM	15903	11927	9542	7951	5963
				(240-360)	Fz	0.115	0.185	0.220	0.290	0.350
				Feed (mm/min)	7315	8826	8397	9223	8349	
PLASTICS	Slot 	1	≤ 1	245	RPM	12987	9740	7792	6494	4870
				(196-294)	Fz	0.050	0.080	0.095	0.125	0.150
				Feed (mm/min)	2597	3117	2961	3247	2922	
	Profile 	≤ 0.5	≤ 1.5	305	RPM	16168	12126	9701	8084	6063
				(244-366)	Fz	0.050	0.080	0.095	0.125	0.150
				Feed (mm/min)	3234	3880	3686	4042	3638	
	HSM 	≤ 0.5	≤ 2	505	RPM	26769	20077	16062	13385	10038
				(404-606)	Fz	0.115	0.185	0.220	0.290	0.350
				Feed (mm/min)	12314	14857	14134	15526	14054	
MACHINABLE CERAMICS MACHINABLE GLASS	Slot 	1	≤ 1	10	RPM	530	398	318	265	199
				(8-12)	Fz	0.020	0.035	0.045	0.050	0.060
				Feed (mm/min)	42	56	57	53	48	
	Profile 	≤ 0.5	≤ 1.5	15	RPM	795	596	477	398	298
				(12-18)	Fz	0.020	0.035	0.045	0.050	0.060
				Feed (mm/min)	64	83	86	80	72	
	HSM 	≤ 0.5	≤ 2	25	RPM	1325	994	795	663	497
				(20-30)	Fz	0.045	0.075	0.085	0.115	0.140
				Feed (mm/min)	239	298	270	305	278	

HSM (High Speed Machining)
 $rpm = Vc \times 3.82 / D_1$
 $ipm = Fz \times 4 \times rpm$
 adjust parameters based on resin type and fiber structure
 reduce speed when overheating causes melting or damage to resin
 reduce feed if delamination or fraying occur
 finish cuts typically required reduced feed and cutting depths

rates shown are for use without coolant; rates may be increased with coolant
 dust collection is vital when machining dry
 diamond coating will increase tool life in graphite and composite materials
 refer to the KYOCERA SGS Tool Wizard® for complete technical information
 (www.kyocera-sgstool.com)

High Performance Aluminum End Mills



Milling

HIGH PERFORMANCE ALUMINUM END MILLS	SERIES	DESCRIPTION	PAGE
S-Carb APR® & APF®	43APR	3 Flute Advanced Productivity Rougher Fractional	123
	43APR-3	3 Flute Advanced Productivity Rougher Fractional	129
	43APR-4	4 Flute Advanced Productivity Rougher Fractional	130
	43MAPR	3 Flute Advanced Productivity Rougher Metric	127
	43APF	4 Flute Advanced Productivity Finisher Fractional	125
	43MAPF	4 Flute Advanced Productivity Finisher Metric	132
S-Carb® (3 Flute)	43	3 Flute Non-Ferrous Square End Fractional	134
	43M	3 Flute Non-Ferrous Square End Metric (Unpolished Flutes)	147
	43M	3 Flute Non-Ferrous Square End Metric (Polished Flutes)	147
	43CR	3 Flute Non-Ferrous Corner Radius Fractional	135
	43MCR	3 Flute Non-Ferrous Corner Radius Metric (Unpolished Flutes)	148
	43MCR	3 Flute Non-Ferrous Corner Radius Metric (Polished Flutes)	149
	43MCR	3 Flute Non-Ferrous Corner Radius 4xD Metric (Polished Flutes)	150
	43LC	3 Flute Non-Ferrous Long Reach Corner Radius Fractional	139
	43MLC	3 Flute Non-Ferrous Long Reach Corner Radius Metric (Unpolished Flutes)	152
	43MLC	3 Flute Non-Ferrous Long Reach Corner Radius Metric (Polished Flutes)	153
	43L	3 Flute Non-Ferrous Square End Long Reach Fractional	138
	43ML	3 Flute Non-Ferrous Square End Long Reach Metric	151
	43EC	3 Flute Non-Ferrous Square End Extra Long Reach Fractional	141
	43B	3 Flute Non-Ferrous Ball End Fractional	142
	43MB	3 Flute Non-Ferrous Ball End Metric (Polished Flutes)	154
	43LB	3 Flute Non-Ferrous Ball End Long Reach Fractional	143
	43EB	3 Flute Non-Ferrous Ball End Extra Long Reach Fractional	143
S-Carb® Rougher (3 Flute)	43CB	3 Flute Rougher Non-Ferrous Chip Breaker Fractional	144
	43MCB	3 Flute Rougher Non-Ferrous Chip Breaker Metric	155
	43LCB	3 Flute Rougher Non-Ferrous Chip Breaker Long Reach Fractional	145
S-Carb® (2 Flute)	47	2 Flute Non-Ferrous Square End Fractional	157
	47M	2 Flute Non-Ferrous Square End Metric	160
	47B	2 Flute Non-Ferrous Ball End Fractional	158
	47MB	2 Flute Non-Ferrous Ball End Metric	162
	47L	2 Flute Non-Ferrous Square End Long Reach Fractional	157
	47ML	2 Flute Non-Ferrous Square End Long Reach Metric	161
	47LB	2 Flute Non-Ferrous Ball End Long Reach Fractional	158
	47MLB	2 Flute Non-Ferrous Ball End Long Reach Metric	162
Ski-Carb	44	2 Flute Non-Ferrous Materials Square End Fractional	164
	44M	2 Flute Non-Ferrous Materials Square End Metric	166
	45	2 Flute Non-Ferrous Materials Long Reach Corner Radius Fractional	168

Speed & Feed Recommendations listed after each series

Fresado

FRESAS DE ALTO RENDIMIENTO PARA ALUMINIO	SERIE	DESCRIPCIÓN	PÁGINA
S-Carb APR® y APF®	43APR	3 filos, productividad avanzada, desbastador, fraccional	123
	43APR-3	3 filos, productividad avanzada, desbastador, fraccional	129
	43APR-4	4 filos, productividad avanzada, desbastador, fraccional	130
	43MAPR	3 filos, productividad avanzada, desbastador, métrico	127
	43APF	4 filos, productividad avanzada, acabador, fraccional	125
	43MAPF	4 filos, productividad avanzada, acabador, métrico	132
S-Carb® (3 filos)	43	3 filos, no férrico, punta cuadrada, fraccional	134
	43M	3 filos, no férrico, punta cuadrada, métrico (filos no pulidos)	147
	43M	3 filos, no férrico, punta cuadrada, métrico (filos pulidos)	147
	43CR	3 filos, no férrico, radio angulado, fraccional	135
	43MCR	3 filos, no férrico, radio angulado, métrico (filos no pulidos)	148
	43MCR	3 filos, no férrico, radio angulado, métrico (filos pulidos)	149
	43MCR	3 filos, no férrico, radio angulado 4xD, métrico (filos pulidos)	150
	43LC	3 filos, no férricos, largo alcance, radio angulado, fraccional	139
	43MLC	3 filos, no férrico, largo alcance, radio angulado, métrico (filos no pulidos)	152
	43MLC	3 filos, no férrico, largo alcance, radio angulado, métrico (filos pulidos)	153
	43L	3 filos, no férrico, punta cuadrada, largo alcance, fraccional	138
	43ML	3 filos, no férrico, punta cuadrada, largo alcance, métrico	151
	43EC	3 filos, no férrico, punta cuadrada, alcance extralargo, fraccional	141
	43B	3 filos, no férrico, punta esférica, fraccional	142
	43MB	3 filos, no férrico, punta esférica, métrico (filos pulidos)	154
	43LB	3 filos, no férrico, punta esférica, largo alcance, fraccional	143
	43EB	3 filos, no férrico, punta esférica, alcance extralargo, fraccional	143
Desbastador S-Carb® (3 filos)	43CB	3 filos, desbastador, no férrico, rompevirutas, fraccional	144
	43MCB	3 filos, desbastador, no férrico, rompevirutas, métrico	155
	43LCB	3 filos, desbastador, no férrico, rompevirutas, largo alcance, fraccional	145
S-Carb® (2 filos)	47	2 filos, no férrico, punta cuadrada, fraccional	157
	47M	2 filos, no férrico, punta cuadrada, métrico	160
	47B	2 filos, no férrico, punta esférica, fraccional	158
	47MB	2 filos, no férrico, punta esférica, métrico	162
	47L	2 filos, no férrico, punta cuadrada, largo alcance, fraccional	157
	47ML	2 filos, no férrico, punta cuadrada, largo alcance, métrico	161
	47LB	2 filos, no férrico, punta esférica, largo alcance, fraccional	158
47MLB	2 filos, no férrico, punta esférica, largo alcance, métrico	162	
Ski-Carb	44	2 filos, materiales no férricos, punta cuadrada, fraccional	164
	44M	2 filos, materiales no férricos, punta cuadrada, métrico	166
	45	2 filos, materiales no férricos, largo alcance, radio angulado, fraccional	168

Recomendaciones de velocidades y avances mostradas tras cada serie

FRAISE HAUTE PERFORMANCE POUR ALUMINIUM	SÉRIES	DESCRIPTION	PAGE
S-Carb APR®/APF®	43APR	3 dents productivité avancée d'ébauche (fractionnel)	123
	43APR-3	3 dents productivité avancée d'ébauche (fractionnel)	129
	43APR-4	4 dents productivité avancée d'ébauche (fractionnel)	130
	43MAPR	3 dents productivité avancée d'ébauche (métrique)	127
	43APF	4 dents productivité avancée de finition (fractionnel)	125
	43MAPF	4 dents productivité avancée de finition (métrique)	132
S-Carb® (3 dents)	43	3 dents non-ferreux à bout plat (fractionnel)	134
	43M	3 dents non-ferreux à bout plat (métrique) (goujures non polies)	147
	43M	3 dents non-ferreux à bout plat (métrique) (goujures polies)	147
	43CR	3 dents non-ferreux rayon en coin (fractionnel)	135
	43MCR	3 dents matériaux non-ferreux rayon en coin (métrique) (goujures non polies)	148
	43MCR	3 dents matériaux non-ferreux rayon en coin (métrique) (goujures polies)	149
	43MCR	3 dents matériaux non-ferreux rayon en coin 4xD (métrique) (goujures polies)	150
	43LC	3 dents non-ferreux longue portée rayon en coin (fractionnel)	139
	43MLC	3 dents non-ferreux longue portée rayon en coin (métrique) (goujures non polies)	152
	43MLC	3 dents non-ferreux longue portée rayon en coin (métrique) (goujures polies)	153
	43L	3 dents non-ferreux à bout plat longue portée (fractionnel)	138
	43ML	3 dents non-ferreux à bout plat longue portée (métrique)	151
	43EC	3 dents non-ferreux à bout plat portée extra-longue (fractionnel)	141
	43B	3 dents non-ferreux à bout hémisphérique (fractionnel)	142
	43MB	3 dents non-ferreux à bout hémisphérique (métrique) (goujures polies)	154
	43LB	3 dents non-ferreux à bout hémisphérique longue portée (fractionnel)	143
43EB	3 dents non-ferreux à bout hémisphérique portée extra-longue (fractionnel)	143	
S-Carb® d'ébauche (3 dents)	43CB	3 dents d'ébauche non-ferreux brise-copeaux (fractionnel)	144
	43MCB	3 dents d'ébauche non-ferreux brise-copeaux (métrique)	155
	43LCB	3 dents d'ébauche non-ferreux brise-copeaux longue portée (fractionnel)	145
S-Carb® (2 dents)	47	2 dents non-ferreux à bout plat (fractionnel)	157
	47M	2 dents non-ferreux à bout plat (métrique)	160
	47B	2 dents non-ferreux à bout hémisphérique (fractionnel)	158
	47MB	2 dents non-ferreux à bout hémisphérique (métrique)	162
	47L	2 dents non-ferreux à bout plat longue portée (fractionnel)	157
	47ML	2 dents non-ferreux à bout plat longue portée (métrique)	161
	47LB	2 dents non-ferreux à bout hémisphérique longue portée (fractionnel)	158
	47MLB	2 dents non-ferreux à bout hémisphérique longue portée (métrique)	162
Ski-Carb	44	2 dents matériaux non-ferreux à bout plat (fractionnel)	164
	44M	2 dents matériaux non-ferreux à bout plat (métrique)	166
	45	2 dents matériaux non-ferreux longue portée rayon en coin (fractionnel)	168

Recommandations de vitesse et avance indiquées après chaque série

HOCHLEISTUNGS-SCHAFFFRÄSER	SERIE	BESCHREIBUNG	SEITE
S-Carb APR® & APF®	43APR	Zölliger Hochleistungs-Stirnschruppfräser mit 3 Schneidekanten	123
	43APR-3	Zölliger Hochleistungs-Stirnschruppfräser mit 3 Schneidekanten	129
	43APR-4	Zölliger Hochleistungs-Stirnschruppfräser mit 4 Schneidekanten	130
	43MAPR	Metrischer Hochleistungs-Stirnschruppfräser mit 3 Schneidekanten	127
	43APF	Zölliger Hochleistungs-Schlichtfräser mit 4 Schneidekanten	125
	43MAPF	Metrischer Hochleistungs-Schlichtfräser mit 4 Schneidekanten	132
	S-Carb® (3 Schneidekanten)	43	Zölliger Nichteisenmetall-Schafffräser mit 3 Schneidekanten ohne Eckenradien
43M		Metrischer Nichteisenmetall-Schafffräser mit 3 unpolierten Schneidekanten ohne Eckenradien	147
43M		Metrischer Nichteisenmetall-Schafffräser mit 3 polierten Schneidekanten ohne Eckenradien	147
43CR		Zölliger Nichteisenmetall-Fräser mit 3 Schneidekanten und Eckenradien	135
43MCR		Metrischer Nichteisenmetall-Fräser mit 3 unpolierten Schneidekanten und Eckenradien	148
43MCR		Metrischer Nichteisenmetall-Fräser mit 3 polierten Schneidekanten und Eckenradien	149
43MCR		Metrischer Nichteisenmetall-Fräser mit 3 polierten Schneidekanten und 4xD-Eckenradien	150
43LC		Zölliger Tiefbohr-fräser mit 3 Schneidekanten und Eckenradien	139
43MLC		Metrischer Nichteisenmetall-Tiefbohr-fräser mit 3 unpolierten Schneidekanten und Eckenradien	152
43MLC		Metrischer Nichteisenmetall-Tiefbohr-fräser mit 3 polierten Schneidekanten und Eckenradien	153
43L		Zölliger Nichteisenmetall-Langloch-Schafffräser mit 3 Schneidekanten ohne Eckenradien	138
43ML		Metrischer Nichteisenmetall-Langloch-Schafffräser mit 3 Schneidekanten ohne Eckenradien	151
43EC		Zölliger Nichteisenmetall-Superlangloch-Schafffräser mit 3 Schneidekanten ohne Eckenradien	141
43B		Zölliger Nichteisenmetall-Radiuschafffräser mit 3 Schneidekanten	142
43MB		Metrischer Nichteisenmetall-Radiuschafffräser mit 3 polierten Schneidekanten	154
43LB		Zölliger Nichteisenmetall-Langloch-Radiuschafffräser mit 3 Schneidekanten	143
43EB		Zölliger Nichteisenmetall-Superlangloch-Radiuschafffräser mit 3 Schneidekanten	143
S-Carb® Schruppfräser (3 Schneidekanten)	43CB	Zölliger Nichteisenmetall-Schruppfräser mit 3 Spanteilernuten	144
	43MCB	Metrischer Nichteisenmetall-Schruppfräser mit 3 Spanteilernuten	155
	43LCB	Zölliger Nichteisenmetall-Langloch-Schruppfräser mit 3 Spanteilernuten	145
S-Carb® (2 Schneidekanten)	47	Zölliger Nichteisenmetall-Schafffräser mit 2 Schneidekanten ohne Eckenradien	157
	47M	Metrischer Nichteisenmetall-Schafffräser mit 2 Schneidekanten ohne Eckenradien	160
	47B	Zölliger Nichteisenmetall-Radiuschafffräser mit 2 Schneidekanten	158
	47MB	Metrischer Nichteisenmetall-Radiuschafffräser mit 2 Schneidekanten	162
	47L	Zölliger Nichteisenmetall-Langloch-Schafffräser mit 2 Schneidekanten ohne Eckenradien	157
	47ML	Metrischer Nichteisenmetall-Langloch-Schafffräser mit 2 Schneidekanten ohne Eckenradien	161
	47LB	Zölliger Nichteisenmetall-Langloch-Radiuschafffräser mit 2 Schneidekanten	158
47MLB	Metrischer Nichteisenmetall-Langloch-Radiuschafffräser mit 2 Schneidekanten	162	
Ski-Carb	44	Zölliger Schafffräser mit 2 Schneidekanten ohne Eckenradien für Nichteisenmetalle	164
	44M	Metrischer Schafffräser mit 2 Schneidekanten ohne Eckenradien für Nichteisenmetalle	166
	45	Zölliger Tiefbohr-fräser mit 2 Schneidekanten und Eckenradien für Nichteisenmetalle	168

Empfehlungen für Drehzahl & Vorschub im Anhang zu jeder Serie

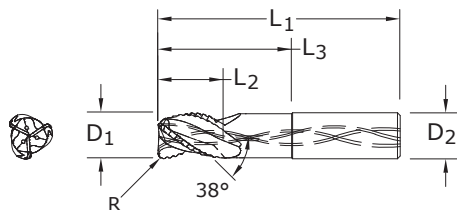

TOLERANCES (inch)

3/4-1 DIAMETER

$D_1 = +0.00040/-0.0020$

$D_2 = h_6$

$R = +0.0000/-0.0012$

NON-FERROUS

For patent information visit www.ksptpatents.com

43APR
FRACTIONAL SERIES





inch						EDP NO.
CUTTING DIAMETER D_1	LENGTH OF CUT L_2	OVERALL LENGTH L_1	SHANK DIAMETER D_2	REACH L_3	CORNER RADIUS R	Ti-NAMITE-B (TiB ₂)
3/4	1-3/8	4-1/4	3/4	2-3/8	.030	34000
3/4	1-3/8	4-1/4	3/4	2-3/8	.060	34001
3/4	1-3/8	4-1/4	3/4	2-3/8	.090	34002
3/4	1-3/8	4-1/4	3/4	2-3/8	.120	34003
3/4	1-1/4	4-7/8	3/4	3	.030	34004
3/4	1-1/4	4-7/8	3/4	3	.060	34005
3/4	1-1/4	4-7/8	3/4	3	.090	34006
3/4	1-1/4	4-7/8	3/4	3	.120	34007
1	1-3/4	4-1/2	1	2-1/2	.030	34008
1	1-3/4	4-1/2	1	2-1/2	.060	34009
1	1-3/4	4-1/2	1	2-1/2	.090	34010
1	1-3/4	4-1/2	1	2-1/2	.120	34011
1	1-1/2	5-1/4	1	3-1/4	.030	34012
1	1-1/2	5-1/4	1	3-1/4	.060	34013
1	1-1/2	5-1/4	1	3-1/4	.090	34014
1	1-1/2	5-1/4	1	3-1/4	.120	34015

- Ultra high-productivity rougher for Aluminum alloys, specifically for aircraft components
- Designed for machine tools with capability of 600 in³ per minute material removal rates
- Symmetrical end gashing for excellent balance at high speeds and aggressive plunging capability
- Open fluting for deep slotting and profiling
- Polished flutes maximize chip evacuation and provides enhanced finish
- Recommended for materials ≤ 150 Bhn (≤ 7 HRC)

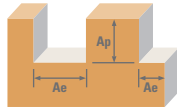
Available on request: • JetStream Technology • Side exit coolant holes

FRACTIONAL
S-Carb APR®



Series 43APR Fractional	Hardness		Ae x D ₁	Ap x D ₁	Vc (sfm)	Diameter (D ₁) (inch)		
						3/4	1	
N	ALUMINUM ALLOYS 2024, 5052, 5086, 6061, 6063, 7075	Slot 	1	≤ 1	4920	RPM	25059	18794
					(3936-5904)	Fz	0.0060	0.0070
						Feed (in/min)	451	395
		Profile 	≤ 0.5	≤ 1.5	6560	RPM	33412	25059
					(5248-7872)	Fz	0.0060	0.0070
						Feed (in/min)	601	526
ALUMINUM ALLOYS (LITHIUM)* 2090, 2091, 2099, 2195, 2199, 2297, 8090	Slot 	1	≤ 1	3940	RPM	20068	15051	
				(3152-4728)	Fz	0.0045	0.0053	
					Feed (in/min)	271	239	
	Profile 	≤ 0.5	≤ 1.5	4920	RPM	25059	18794	
				(3936-5904)	Fz	0.0045	0.0053	
					Feed (in/min)	338	299	

Bhn (Brinell) HRc (Rockwell C)
 surface speed is dependent on machine spindle and fixturing
 balancing is recommended at ultra high surface speeds
 tool life may be reduced when machining Lithium Alloys
 $rpm = Vc \times 3.82 / D_1$
 $ipm = Fz \times 3 \times rpm$
 maximum recommended depths shown
 reduce speed and feed for materials harder than listed
 ramp angle = 15° (feed rate = 50%)
 plunge depth = 1 x D₁ (feed rate = 30%)
 refer to the KYOCERA SGS Tool Wizard® for complete technical information (www.kyocera-sgstool.com)

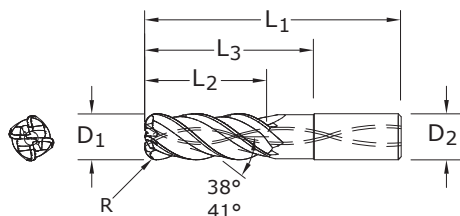

TOLERANCES (inch)

1/2–3/4 DIAMETER

$D_1 = +0.00040/-0.0020$

$D_2 = h_6$

$R = +0.0000/-0.0012$

NON-FERROUS

For patent information visit www.ksptpatents.com

43APF
FRACTIONAL SERIES





inch						EDP NO.
CUTTING DIAMETER D_1	LENGTH OF CUT L_2	OVERALL LENGTH L_1	SHANK DIAMETER D_2	REACH L_3	CORNER RADIUS R	Ti-NAMITE-B (TiB ₂)
1/2	1-1/4	3-1/4	1/2	1-5/8	.030	34016
1/2	1-1/4	3-1/4	1/2	1-5/8	.060	34017
1/2	1-1/4	3-1/4	1/2	1-5/8	.090	34018
1/2	1-1/4	3-1/4	1/2	1-5/8	.120	34019
1/2	2	4	1/2	2-3/8	.030	34020
1/2	2	4	1/2	2-3/8	.060	34021
1/2	2	4	1/2	2-3/8	.090	34022
1/2	2	4	1/2	2-3/8	.120	34023
3/4	1-7/8	4-1/4	3/4	2-3/8	.030	34024
3/4	1-7/8	4-1/4	3/4	2-3/8	.060	34025
3/4	1-7/8	4-1/4	3/4	2-3/8	.090	34026
3/4	1-7/8	4-1/4	3/4	2-3/8	.120	34027
3/4	3	5-3/8	3/4	3-1/2	.030	34028
3/4	3	5-3/8	3/4	3-1/2	.060	34029
3/4	3	5-3/8	3/4	3-1/2	.090	34030
3/4	3	5-3/8	3/4	3-1/2	.120	34031

- Ultra high-productivity finisher for Aluminum alloys, specifically for aircraft components
- Two levels of chatter suppression: variable helix and indexing
- Designed for single axial pass semi-finishing and finishing
- Polished flutes maximize chip evacuation and provides enhanced finish
- Recommended for materials ≤ 150 Bhn (≤ 7 HRc)

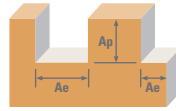
Available on request: • JetStream Technology

FRACTIONAL
S-Carb APF®



Series 43APF Fractional	Hardness	Ae x D ₁	Ap x D ₁	Vc (sfm)	Diameter (D ₁) (inch)				
					1/2	3/4			
N	ALUMINUM ALLOYS 2024, 5052, 5086, 6061, 6063, 7075	≤ 150 Bhn or ≤ 7 HRc	Profile 	≤ 0.1	≤ 2.5	2625	RPM	20055	13370
						(2100-3150)	Fz	0.0030	0.0050
						(2100-3150)	Feed (in/min)	241	267
		Profile 	≤ 0.1	≤ 4	2625	RPM	20055	13370	
					(2100-3150)	Fz	0.0020	0.0040	
					(2100-3150)	Feed (in/min)	160	214	
ALUMINUM ALLOYS (LITHIUM)* 2090, 2091, 2099, 2195, 2199, 2297, 8090	≤ 150 Bhn or ≤ 7 HRc	Profile 	≤ 0.1	≤ 2.5	1970	RPM	15051	10034	
					(1576-2364)	Fz	0.0030	0.0050	
					(1576-2364)	Feed (in/min)	181	201	
		Profile 	≤ 0.1	≤ 4	1970	RPM	15051	10034	
					(1576-2364)	Fz	0.0020	0.0040	
					(1576-2364)	Feed (in/min)	120	161	

Bhn (Brinell) HRc (Rockwell C)
 surface speed is dependent on machine spindle and fixturing
 balancing is recommended at ultra high surface speeds
 tool life may be reduced when machining Lithium Alloys
 $rpm = Vc \times 3.82 / D_1$
 $ipm = Fz \times 4 \times rpm$
 maximum recommended depths shown
 reduce speed and feed for materials harder than listed
 finish cuts typically require reduced feed and cutting depths of 0.02 X D₁ maximum
 ramp angle = 6° (feed rate = 50%)
 plunging not recommended
 refer to the KYOCERA SGS Tool Wizard® for complete technical information (www.kyocera-sgstool.com)

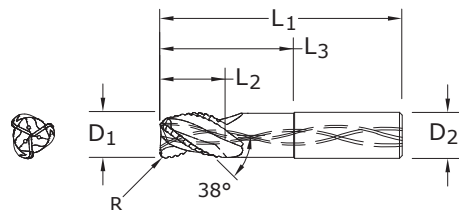
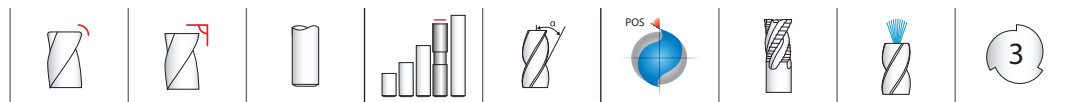

TOLERANCES (mm)

12–25 DIAMETER

$D_1 = +0,010/-0,050$

$D_2 = h_6$

$R = +0,000/-0,030$

NON-FERROUS

For patent information visit www.ksptpatents.com

43MAPR
METRIC SERIES





mm						EDP NO.
CUTTING DIAMETER D_1	LENGTH OF CUT L_2	OVERALL LENGTH L_1	SHANK DIAMETER D_2	REACH L_3	CORNER RADIUS R	Ti-NAMITE-B (TiB ₂)
12,0	18,0	83,0	12,0	38,0	—	44650
12,0	18,0	83,0	12,0	38,0	2,0	44685
12,0	18,0	83,0	12,0	38,0	3,0	44686
12,0	18,0	83,0	12,0	38,0	4,0	44687
16,0	24,0	92,0	16,0	51,0	—	44652
16,0	24,0	92,0	16,0	51,0	2,0	44688
16,0	24,0	92,0	16,0	51,0	3,0	44689
16,0	24,0	92,0	16,0	51,0	4,0	44690
20,0	30,0	86,0	20,0	45,0	—	44646
20,0	30,0	86,0	20,0	45,0	3,0	44647
20,0	30,0	86,0	20,0	45,0	4,0	44648
20,0	30,0	86,0	20,0	45,0	5,0	44649
20,0	35,0	104,0	20,0	64,0	—	44653
20,0	35,0	104,0	20,0	64,0	3,0	44691
20,0	35,0	104,0	20,0	64,0	4,0	44692
20,0	35,0	104,0	20,0	64,0	5,0	44693
25,0	35,0	108,0	25,0	55,0	3,0	44809
25,0	35,0	108,0	25,0	55,0	4,0	44810
25,0	35,0	108,0	25,0	55,0	5,0	44811
25,0	35,0	140,0	25,0	80,0	—	44654
25,0	35,0	140,0	25,0	80,0	3,0	44694
25,0	35,0	140,0	25,0	80,0	4,0	44695
25,0	35,0	140,0	25,0	80,0	5,0	44696
25,0	35,0	140,0	25,0	90,0	3,0	44645

- Ultra high-productivity rougher for Aluminum alloys, specifically for aircraft components
- Designed for machine tools with capability of 9.83 l³ per minute material removal rates
- Symmetrical end gashing for excellent balance at high speeds and aggressive plunging capability
- Open fluting for deep slotting and profiling
- Polished flutes maximize chip evacuation and provides enhanced finish
- Recommended for materials ≤ 150 Bhn (≤ 7 HRc)

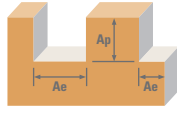
Available on request: • JetStream Technology • Side exit coolant holes

S-Carb APR[®]



Series 43MAPR Metric	Hardness	Ae x D ₁	Ap x D ₁	Vc (m/min)	Diameter (D ₁) (mm)					
					12	16	20	25		
N	ALUMINUM ALLOYS 2024, 5052, 5086, 6061, 6063, 7075	Slot 	1	≤ 1	1500	RPM	39788	29841	23873	19098
					(1200-1800)	Fz	0.080	0.110	0.150	0.180
					Feed (mm/min)	9549	9848	10743	10313	
					2000	RPM	53050	39788	31830	25464
	ALUMINUM ALLOYS (LITHIUM)* 2090, 2091, 2099, 2195, 2199, 2297, 8090	Profile 	≤ 0.5	≤ 1.5	(1600-2400)	Fz	0.080	0.110	0.150	0.180
					Feed (mm/min)	12732	13130	14324	13751	
					1200	RPM	31830	23873	19098	15278
					(960-1440)	Fz	0.060	0.083	0.110	0.140
ALUMINUM ALLOYS (LITHIUM)* 2090, 2091, 2099, 2195, 2199, 2297, 8090	Slot 	1	≤ 1	1500	RPM	39788	29841	23873	19098	
				(1200-1800)	Fz	0.060	0.083	0.110	0.140	
				Feed (mm/min)	7162	7430	7878	8021		
				1500	RPM	39788	29841	23873	19098	
ALUMINUM ALLOYS (LITHIUM)* 2090, 2091, 2099, 2195, 2199, 2297, 8090	Profile 	≤ 0.5	≤ 1.5	(1200-1800)	Fz	0.060	0.083	0.110	0.140	
				Feed (mm/min)	7162	7430	7878	8021		

Bhn (Brinell) HRC (Rockwell C)
 surface speed is dependent on machine spindle and fixturing
 balancing is recommended at ultra high surface speeds
 tool life may be reduced when machining Lithium Alloys
 $rpm = (Vc \times 1000) / (D_1 \times 3.14)$
 $mm/min = Fz \times 3 \times rpm$
 maximum recommended depths shown
 reduce speed and feed for materials harder than listed
 ramp angle = 15° (feed rate = 50%)
 plunge depth = 1 x D₁ (feed rate = 30%)
 refer to the KYOCERA SGS Tool Wizard[®] for complete technical information (www.kyocera-sgstool.com)

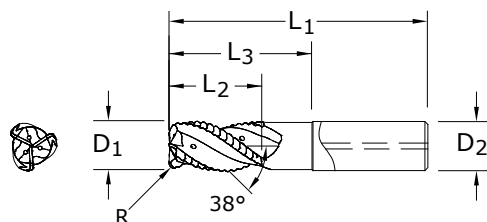

TOLERANCES (mm)

20–25 DIAMETER

$D_1 = -0,01/-0,10$

$D_2 = h_6$

$R = +/-0,05$

NON-FERROUS

For patent information visit www.ksptpatents.com

43APR-3
METRIC SERIES

inch						EDP NO.
CUTTING DIAMETER D_1	LENGTH OF CUT L_2	OVERALL LENGTH L_1	SHANK DIAMETER D_2	REACH L_3	CORNER RADIUS R	Ti-NAMITE-B (TiB ₂)
20,0	35,0	86,0	20,0	—	—	44990
20,0	35,0	86,0	20,0	45,0	3,0	44991
20,0	35,0	86,0	20,0	45,0	4,0	44992
20,0	35,0	106,0	20,0	—	—	44993
20,0	35,0	106,0	20,0	65,0	2,0	44994
20,0	35,0	106,0	20,0	65,0	3,0	44995
20,0	35,0	106,0	20,0	65,0	4,0	44996
20,0	35,0	106,0	20,0	65,0	5,0	44997
25,0	43,0	108,0	25,0	—	—	44998
25,0	43,0	108,0	25,0	60,0	2,0	44999
25,0	43,0	108,0	25,0	60,0	3,0	45000
25,0	43,0	108,0	25,0	60,0	4,0	45001
25,0	35,0	140,0	25,0	—	—	45002
25,0	35,0	140,0	25,0	80,0	3,0	45003
25,0	35,0	140,0	25,0	90,0	3,0	45004

- Ultra high-productivity rougher for Aluminum alloys, specifically for aircraft components
- Designed for machine tools with capability of 12 IP per minute material removal rates
- New 3 flute variable geometry with side exit coolant holes
- Open fluting for deep slotting and profiling
- Recommended for materials ≤ 150 Bhn (≤ 7 HRC)

METRIC

S-Carb APR[®]

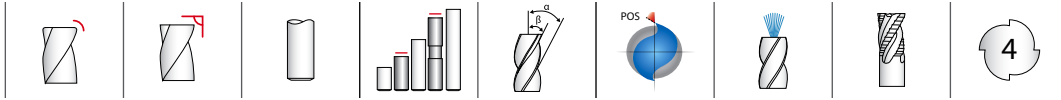

43APR-4 METRIC SERIES

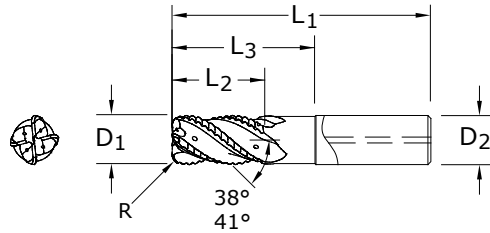

- Ultra high-productivity rougher for Aluminum alloys, specifically for aircraft components
- Designed for machine tools with capability of 12 l³ per minute material removal rates
- New 4 flute variable geometry with side exit coolant holes
- Open fluting for deep slotting and profiling
- Recommended for materials ≤ 150 Bhn (≤ 7 HRc)

CUTTING DIAMETER D ₁	LENGTH OF CUT L ₂	inch				CORNER RADIUS R	EDP NO. Ti-NAMITE-B (TiB ₂)
		OVERALL LENGTH L ₁	SHANK DIAMETER D ₂	REACH L ₃			
20,0	35,0	86,0	20,0	—	—	45005	
20,0	35,0	86,0	20,0	45,0	3,0	45006	
20,0	35,0	86,0	20,0	45,0	4,0	45007	
20,0	35,0	106,0	20,0	—	—	45008	
20,0	35,0	106,0	20,0	65,0	2,0	45009	
20,0	35,0	106,0	20,0	65,0	3,0	45010	
20,0	35,0	106,0	20,0	65,0	4,0	45011	
20,0	35,0	106,0	20,0	65,0	5,0	45012	
25,0	43,0	108,0	25,0	—	—	45013	
25,0	43,0	108,0	25,0	60,0	2,0	45014	
25,0	43,0	108,0	25,0	60,0	3,0	45015	
25,0	43,0	108,0	25,0	60,0	4,0	45016	
25,0	35,0	140,0	25,0	—	—	45017	
25,0	35,0	140,0	25,0	80,0	3,0	45018	
25,0	35,0	140,0	25,0	90,0	3,0	45019	

TOLERANCES (mm)

20–25 DIAMETER

D₁ = -0,01/-0,10

D₂ = h₆

R = +/-0,05

NON-FERROUS

For patent information visit www.ksptpatents.com

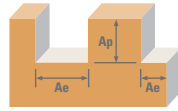

Series 43APR-3 43APR-4 Metric		Ae x D ₁	Ap x D ₁	Vc (m/min)	Diameter (D ₁) (mm)				
					APR-3		APR-4		
					20	25	20	25	
N ALUMINIUM ALLOYS 6068, 7075	Slot 	1	≤ 1	1600 (300-2100)	RPM	25461	20369	25461	20369
					Fz	0.12	0.12	0.12	0.12
					Feed (mm/min)	9166	7333	12222	9777
	Profile 	≤ 0.5	≤ 1.5	1800 (300-2100)	RPM	28644	22915	28644	22915
					Fz	0.15	0.15	0.15	0.15
					Feed (mm/min)	12890	10312	17187	13749
	HSM 	≤ 0.1	≤ 2	2100 (300-2100)	RPM	33418	26735	33418	26735
					Fz	0.18	0.18	0.18	0.18
					Feed (mm/min)	18046	14437	24061	19249

For best results use the peak power of the specific machine torque chart.

Typically 10kw is required to remove 1 litre of material (MMR).

Eg. >> (Ae x Ap x Feed) / 1000000 >> Therefore Full slotting Ø25: 25 x 25 x 7333 = 4.58 Litres so it needs a min of 46Kw.

Larger cuts and chip load consume more power.

Review the power chart of each machine to determine MAX power for ultimate performance.

Example below shows peak power @ 10,000 rpm.

The APR-4 design is for ultimate metal removal but typically requires more power, and is also better suited to horizontal machines.

The new coolant supply is designed for MQL as well as normal emulsion coolant on the same data.

Ensure max MQL flow prior to cutting.

Refer to the KYOCERA SGS Tool Wizard® for complete technical information (www.kyocera-sgstool.com).

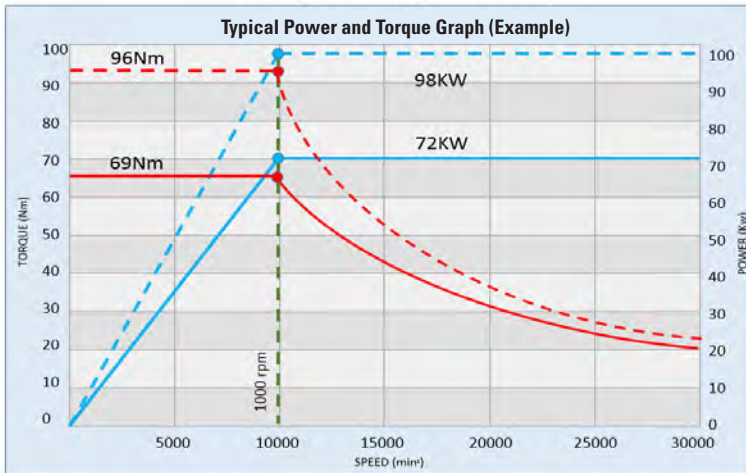

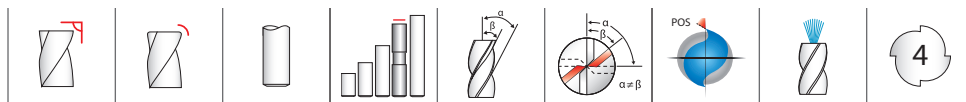

43MAPF
METRIC SERIES

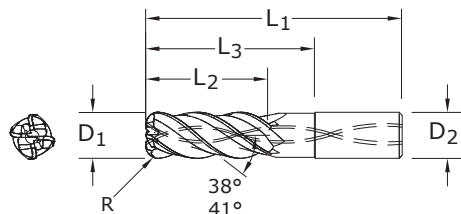

- Ultra high-productivity finisher for Aluminum alloys, specifically for aircraft components
- Two levels of chatter suppression: variable helix and indexing
- Designed for single axial pass semi-finishing and finishing
- Polished flutes maximize chip evacuation and provides enhanced finish
- Recommended for materials ≤ 150 Bhn (≤ 7 HRC)

mm						EDP NO.
CUTTING DIAMETER D ₁	LENGTH OF CUT L ₂	OVERALL LENGTH L ₁	SHANK DIAMETER D ₂	REACH L ₃	CORNER RADIUS R	Ti-NAMITE-B (TiB ₂)
6,0	24,0	58,0	6,0	30,0	—	44627
8,0	32,0	64,0	8,0	40,0	—	44628
10,0	40,0	80,0	10,0	50,0	—	44629
12,0	30,0	83,0	12,0	40,0	—	44630
12,0	30,0	83,0	12,0	40,0	2,0	44745
12,0	30,0	83,0	12,0	40,0	3,0	44746
12,0	30,0	83,0	12,0	40,0	4,0	44747
12,0	30,0	83,0	12,0	50,0	0,5	44641
12,0	30,0	83,0	12,0	50,0	5,0	44642
12,0	48,0	100,0	12,0	62,0	—	44631
12,0	48,0	100,0	12,0	62,0	2,0	44748
12,0	48,0	100,0	12,0	62,0	3,0	44749
12,0	48,0	100,0	12,0	62,0	4,0	44750
16,0	42,0	93,0	16,0	51,0	5,0	44643
16,0	40,0	92,0	16,0	51,0	—	44634
16,0	40,0	92,0	16,0	51,0	2,0	44751
16,0	40,0	92,0	16,0	51,0	3,0	44752
16,0	40,0	92,0	16,0	51,0	4,0	44753
16,0	64,0	125,0	16,0	82,0	—	44635
16,0	64,0	125,0	16,0	82,0	2,0	44754
16,0	64,0	125,0	16,0	82,0	3,0	44755
16,0	64,0	125,0	16,0	82,0	4,0	44756
20,0	50,0	108,0	20,0	63,0	—	44636
20,0	50,0	108,0	20,0	63,0	3,0	44757
20,0	50,0	108,0	20,0	63,0	4,0	44758
20,0	50,0	108,0	20,0	63,0	5,0	44759
20,0	80,0	150,0	20,0	102,0	—	44637
20,0	80,0	150,0	20,0	102,0	3,0	44760
20,0	80,0	150,0	20,0	102,0	4,0	44761
20,0	80,0	150,0	20,0	102,0	5,0	44762
25,0	63,0	130,0	25,0	79,0	—	44638
25,0	63,0	130,0	25,0	79,0	3,0	44763
25,0	63,0	130,0	25,0	79,0	4,0	44764
25,0	63,0	130,0	25,0	79,0	5,0	44765
25,0	100,0	175,0	25,0	120,0	—	44639
25,0	100,0	175,0	25,0	120,0	3,0	44766
25,0	100,0	175,0	25,0	120,0	4,0	44767
25,0	100,0	175,0	25,0	120,0	5,0	44768

TOLERANCES (mm)

6–25 DIAMETER

D₁ = +0,010/–0,050

D₂ = h₆

R = +0,000/–0,030

NON-FERROUS

For patent information visit www.ksptpatents.com

Available on request: • JetStream Technology

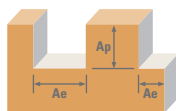

Series 43MAPF Metric	Hardness	Profile	Ae x D ₁	Ap x D ₁	Vc (m/min)	Diameter (D ₁) (mm)							
						6	8	10	12	16	20	25	
N	ALUMINUM ALLOYS 2024, 5052, 5086, 6061, 6063, 7075	Profile 	≤ 0.1	≤ 2.5	800	RPM	42440	31830	25464	21220	15915	12732	10186
					(640-960)	Fz	0.050	0.055	0.060	0.070	0.100	0.140	0.170
					Feed (mm/min)	8488	7003	6111	5942	6366	7130	6926	
	ALUMINUM ALLOYS (LITHIUM)* 2090, 2091, 2099, 2195, 2199, 2297, 8090	Profile 	≤ 0.1	≤ 4	800	RPM	42440	31830	25464	21220	15915	12732	10186
					(640-960)	Fz	0.040	0.045	0.050	0.050	0.070	0.100	0.120
					Feed (mm/min)	6790	5729	5093	4244	4456	5093	4889	
ALUMINUM ALLOYS (LITHIUM)* 2090, 2091, 2099, 2195, 2199, 2297, 8090	Profile 	≤ 0.1	≤ 2.5	600	RPM	31830	23873	19098	15915	11936	9549	7639	
				(480-720)	Fz	0.050	0.055	0.060	0.070	0.100	0.140	0.170	
				Feed (mm/min)	6366	5252	4584	4456	4774	5347	5195		
ALUMINUM ALLOYS (LITHIUM)* 2090, 2091, 2099, 2195, 2199, 2297, 8090	Profile 	≤ 0.1	≤ 4	600	RPM	31830	23873	19098	15915	11936	9549	7639	
				(480-720)	Fz	0.040	0.045	0.050	0.050	0.070	0.100	0.120	
				Feed (mm/min)	5093	4297	3820	3183	3342	3820	3667		

Bhn (Brinell) HRC (Rockwell C)
 surface speed is dependent on machine spindle and fixturing
 balancing is recommended at ultra high surface speeds
 *tool life may be reduced when machining Lithium Alloys
 $rpm = (Vc \times 1000) / (D_1 \times 3.14)$
 $mm/min = Fz \times 4 \times rpm$
 maximum recommended depths shown
 reduce speed and feed for materials harder than listed
 finish cuts typically require reduced feed and cutting depths of 0.02 X D₁ maximum
 ramp angle = 6° (feed rate = 50%)
 plunging not recommended
 refer to the KYOCERA SGS Tool Wizard® for complete technical information (www.kyocera-sgstool.com)

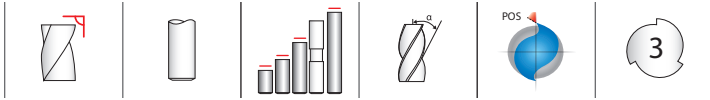

43
FRACTIONAL SERIES

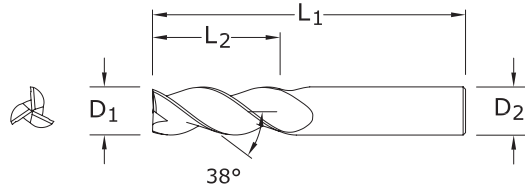

- Circular land allows for increased control at various speed and feed rates and reduces chatter
- Symmetrical end gashing for excellent balance at high speeds and aggressive plunging capability
- Open fluting for deep slotting and profiling
- Recommended for materials ≤ 150 Bhn (≤ 7 HRC)

CUTTING DIAMETER D ₁	inch			EDP NO.	
	LENGTH OF CUT L ₂	OVERALL LENGTH L ₁	SHANK DIAMETER D ₂	UNCOATED	Ti-NAMITE-B (TiB ₂)
1/8	3/8	1-1/2	1/8	34701	34728
3/16	5/16	2-1/2	3/16	34822	34857
3/16	9/16	2	3/16	34702	34729
3/16	3/4	2-1/2	3/16	34823	34858
1/4	3/8	2	1/4	34703	34730
1/4	1/2	2-1/2	1/4	34824	34859
1/4	3/4	2-1/2	1/4	34704	34731
1/4	1	3	1/4	34825	34860
1/4	1-1/4	3-1/2	1/4	34705	34732
1/4	1-3/4	4	1/4	34826	34861
5/16	7/16	2	5/16	34706	34733
5/16	5/8	2-1/2	5/16	34707	34734
5/16	1-1/4	4	5/16	34708	34735
3/8	1/2	2	3/8	34709	34736
3/8	1	2-1/2	3/8	34710	34737
3/8	1-1/4	3-1/2	3/8	34827	34862
3/8	1-1/2	3-1/2	3/8	34711	34738
3/8	2	4	3/8	34828	34863
1/2	5/8	2-1/2	1/2	34712	34739
1/2	1	3	1/2	34830	34865
1/2	1-1/4	3-1/4	1/2	34713	34740
1/2	1-5/8	4	1/2	34831	34866
1/2	2-1/2	5	1/2	34832	34867
1/2	2	4	1/2	34714	34741
1/2	3-1/8	6	1/2	34715	34742
5/8	3/4	3	5/8	34716	34743
5/8	1-5/8	3-3/4	5/8	34717	34744
5/8	2-1/8	4	5/8	34833	34868
5/8	2-1/2	5	5/8	34718	34745
5/8	3-1/4	6	5/8	34834	34869
5/8	3-3/4	6	5/8	34719	34746
3/4	1	3	3/4	34720	34747
3/4	1-5/8	4	3/4	34721	34748
3/4	2-1/4	5	3/4	34722	34749
3/4	3-1/4	6	3/4	34723	34750
1	1-1/4	4	1	34724	34751
1	2	4-1/2	1	34725	34752
1	2-5/8	6	1	34726	34753
1	3-1/4	6	1	34727	34754
1	4-1/8	7	1	34835	34870

TOLERANCES (inch)

1/8–3/16 DIAMETER

D₁ = +0.0000/–0.00032

D₂ = h₆

1/4–3/8 DIAMETER

D₁ = +0.0000/–0.00035

D₂ = h₆

1/2–5/8 DIAMETER

D₁ = +0.0000/–0.00043

D₂ = h₆

3/4–1 DIAMETER

D₁ = +0.0000/–0.00051

D₂ = h₆

NON-FERROUS

PLASTICS/COMPOSITES

For patent information visit www.ksptpatents.com

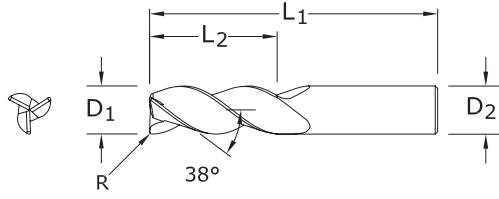
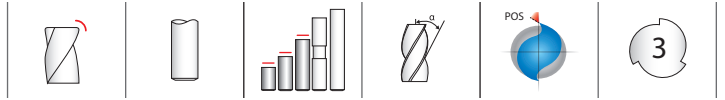

43CR
FRACTIONAL SERIES

TOLERANCES (inch)

1/8–3/16 DIAMETER

D₁ = +0.0000/–0.00032

D₂ = h₆

R = +0.0000/–0.0020

1/4–3/8 DIAMETER

D₁ = +0.0000/–0.00035

D₂ = h₆

R = +0.0000/–0.0020

1/2–5/8 DIAMETER

D₁ = +0.0000/–0.00043

D₂ = h₆

R = +0.0000/–0.0020

3/4–1 DIAMETER

D₁ = +0.0000/–0.00051

D₂ = h₆

R = +0.0000/–0.0020

NON-FERROUS

PLASTICS/COMPOSITES

For patent information visit www.ksptpatents.com

CUTTING DIAMETER D ₁	LENGTH OF CUT L ₂	inch			EDP NO.	
		OVERALL LENGTH L ₁	SHANK DIAMETER D ₂	CORNER RADIUS R	UNCOATED	TI-NAMITE-B (TiB ₂)
1/8	3/8	1-1/2	1/8	.010	34771	34793
3/16	9/16	2	3/16	.010	34772	34794
1/4	3/8	2-1/2	1/4	.010	35575	35665
1/4	3/8	2-1/2	1/4	.015	35576	35666
1/4	3/8	2-1/2	1/4	.030	35577	35667
1/4	3/8	2-1/2	1/4	.060	35578	35668
1/4	3/4	2-1/2	1/4	.010	34773	34795
1/4	3/4	2-1/2	1/4	.015	35579	35669
1/4	3/4	2-1/2	1/4	.030	34774	34796
1/4	3/4	2-1/2	1/4	.060	35580	35670
1/4	1	3	1/4	.010	35581	35671
1/4	1	3	1/4	.015	35582	35672
1/4	1	3	1/4	.030	35583	35673
1/4	1	3	1/4	.060	35584	35674
5/16	5/8	2-1/2	5/16	.030	34775	34797
3/8	1/2	3	3/8	.010	35585	35675
3/8	1/2	3	3/8	.015	35586	35676
3/8	1/2	3	3/8	.030	35587	35677
3/8	1/2	3	3/8	.060	35588	35678
3/8	1/2	3	3/8	.090	35589	35679
3/8	1	2-1/2	3/8	.010	34776	34798
3/8	1	2-1/2	3/8	.030	34777	34799
3/8	1	2-1/2	3/8	.060	32761	32825
3/8	1	3	3/8	.015	35590	35680
3/8	1	3	3/8	.090	35591	35681
3/8	1-1/2	4	3/8	.010	35592	35682
3/8	1-1/2	4	3/8	.015	35593	35683
3/8	1-1/2	4	3/8	.030	35594	35684
3/8	1-1/2	4	3/8	.060	35595	35685
3/8	1-1/2	4	3/8	.090	35596	35686
1/2	5/8	3	1/2	.010	35597	35687
1/2	5/8	3	1/2	.015	35598	35688
1/2	5/8	3	1/2	.030	35599	35689
1/2	5/8	3	1/2	.060	35600	35690
1/2	5/8	3	1/2	.090	35601	35691
1/2	5/8	3	1/2	.120	35602	35692

- Circular land allows for increased control at various speed and feed rates and reduces chatter
- Symmetrical end gashing for excellent balance at high speeds and aggressive plunging capability
- Open fluting for deep slotting and profiling
- Enhanced corner geometry with tight tolerance corner radii
- Recommended for materials ≤ 150 Bhn (≤ 7 HRC)

continued on next page



43CR
FRACTIONAL SERIES

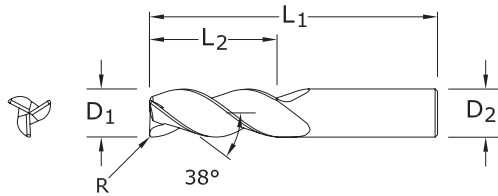

CONTINUED

CUTTING DIAMETER D ₁	LENGTH OF CUT L ₂	inch			EDP NO.	
		OVERALL LENGTH L ₁	SHANK DIAMETER D ₂	CORNER RADIUS R	UNCOATED	Ti-NAMITE-B (TiB ₂)
1/2	1	3	1/2	.010	35603	35693
1/2	1	3	1/2	.015	35604	35694
1/2	1	3	1/2	.030	35605	35695
1/2	1	3	1/2	.060	35606	35696
1/2	1	3	1/2	.090	35607	35697
1/2	1	3	1/2	.120	35608	35698
1/2	1-1/4	3	1/2	.015	35609	35699
1/2	1-1/4	3-1/4	1/2	.010	34778	34800
1/2	1-1/4	3-1/4	1/2	.030	34779	34801
1/2	1-1/4	3-1/4	1/2	.060	34780	34802
1/2	1-1/4	3-1/4	1/2	.090	34781	34803
1/2	1-1/4	3-1/4	1/2	.120	32766	32830
1/2	1-5/8	4	1/2	.010	35610	35700
1/2	1-5/8	4	1/2	.015	35611	35701
1/2	1-5/8	4	1/2	.030	35612	35702
1/2	1-5/8	4	1/2	.060	35613	35703
1/2	1-5/8	4	1/2	.090	35614	35704
1/2	1-5/8	4	1/2	.120	35615	35705
1/2	2	4	1/2	.010	35616	35706
1/2	2	4	1/2	.015	35617	35707
1/2	2	4	1/2	.030	35618	35708
1/2	2	4	1/2	.060	35619	35709
1/2	2	4	1/2	.090	35620	35710
1/2	2	4	1/2	.120	35621	35711
5/8	3/4	3-1/2	5/8	.030	35622	35712
5/8	3/4	3-1/2	5/8	.060	35623	35713
5/8	3/4	3-1/2	5/8	.090	35624	35714
5/8	3/4	3-1/2	5/8	.120	35625	35715
5/8	1-5/8	3-3/4	5/8	.030	34782	34804
5/8	1-5/8	3-3/4	5/8	.060	34783	34805
5/8	1-5/8	3-3/4	5/8	.090	34784	34806
5/8	1-5/8	3-3/4	5/8	.120	35626	35716
3/4	1	4	3/4	.030	35627	35717
3/4	1	4	3/4	.060	35628	35718
3/4	1	4	3/4	.090	35629	35719
3/4	1	4	3/4	.120	35630	35720

continued on next page

TOLERANCES (inch)

1/8–3/16 DIAMETER

D₁ = +0.0000/–0.00032

D₂ = h₆

R = +0.0000/–0.0020

1/4–3/8 DIAMETER

D₁ = +0.0000/–0.00035

D₂ = h₆

R = +0.0000/–0.0020

1/2–5/8 DIAMETER

D₁ = +0.0000/–0.00043

D₂ = h₆

R = +0.0000/–0.0020

3/4–1 DIAMETER

D₁ = +0.0000/–0.00051

D₂ = h₆

R = +0.0000/–0.0020

NON-FERROUS

PLASTICS/COMPOSITES

For patent information visit www.ksptpatents.com



43CR
FRACTIONAL SERIES

CONTINUED

CUTTING DIAMETER D ₁	LENGTH OF CUT L ₂	inch			EDP NO.	
		OVERALL LENGTH L ₁	SHANK DIAMETER D ₂	CORNER RADIUS R	UNCOATED	Ti-NAMITE-B (TiB ₂)
3/4	1	4	3/4	.190	35631	35721
3/4	1	4	3/4	.250	35632	35722
3/4	1-5/8	4	3/4	.030	34785	34807
3/4	1-5/8	4	3/4	.060	34786	34808
3/4	1-5/8	4	3/4	.090	34787	34809
3/4	1-5/8	4	3/4	.120	34815	34817
3/4	1-5/8	4	3/4	.190	35633	35723
3/4	1-5/8	4	3/4	.250	35634	35724
3/4	2-1/4	5	3/4	.030	35635	35725
3/4	2-1/4	5	3/4	.060	35636	35726
3/4	2-1/4	5	3/4	.090	35637	35727
3/4	2-1/4	5	3/4	.120	35638	35728
3/4	2-1/4	5	3/4	.190	35639	35729
3/4	2-1/4	5	3/4	.250	35640	35730
1	1-1/4	5	1	.030	35641	35731
1	1-1/4	5	1	.060	35642	35732
1	1-1/4	5	1	.090	35643	35733
1	1-1/4	5	1	.120	35644	35734
1	1-1/4	5	1	.190	35645	35735
1	1-1/4	5	1	.250	35646	35736
1	2	5	1	.190	35647	35737
1	2	5	1	.250	35648	35738
1	2	4-1/2	1	.030	34789	34811
1	2	4-1/2	1	.060	34790	34812
1	2	4-1/2	1	.090	34791	34813
1	2	4-1/2	1	.120	34816	34818
1	3-1/4	6	1	.030	35649	35739
1	3-1/4	6	1	.060	35650	35740
1	3-1/4	6	1	.090	35651	35741
1	3-1/4	6	1	.120	35652	35742
1	3-1/4	6	1	.190	35653	35743
1	3-1/4	6	1	.250	35654	35744

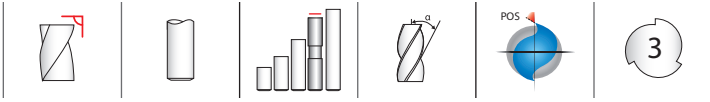

43L
FRACTIONAL SERIES

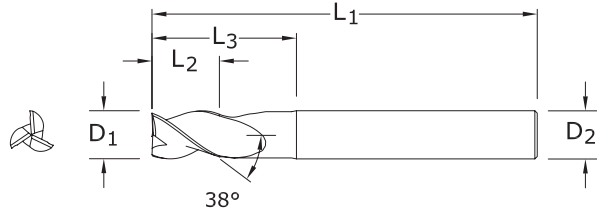

- Circular land allows for increased control at various speed and feed rates and reduces chatter
- Symmetrical end gashing for excellent balance at high speeds and aggressive plunging capability
- Open fluting for deep slotting and profiling
- Necked design with blended diameter transitions provide clearance to reach
- Recommended for materials ≤ 150 Bhn (≤ 7 HRC)

CUTTING DIAMETER D ₁	LENGTH OF CUT L ₂	inch			EDP NO.	
		OVERALL LENGTH L ₁	SHANK DIAMETER D ₂	REACH L ₃	UNCOATED	Ti-NAMITE-B (TiB ₂)
1/8	5/32	3	1/8	1/2	32700	32725
1/8	5/32	3	1/8	3/4	32691	34888
3/16	7/32	3	3/16	1/2	32701	32726
3/16	7/32	3	3/16	3/4	32692	34889
1/4	3/8	4	1/4	3/4	32702	32727
1/4	3/8	4	1/4	1-1/2	32703	32728
1/4	3/8	4	1/4	2-1/8	32704	32729
5/16	7/16	4	5/16	1-1/8	32705	32730
5/16	7/16	4	5/16	2-1/8	32706	32731
3/8	1/2	4	3/8	1-1/8	32707	32732
3/8	1/2	4	3/8	2-1/8	32708	32733
1/2	5/8	4	1/2	1-3/8	32709	32734
1/2	5/8	6	1/2	2-1/8	32710	32735
1/2	5/8	6	1/2	3-3/8	32711	32736
1/2	5/8	6	1/2	4-1/4	32697	34894
5/8	3/4	4	5/8	1-3/4	32712	32737
5/8	3/4	4	5/8	2-3/8	32713	32738
5/8	3/4	6	5/8	3-3/8	32714	32739
5/8	3/4	6	5/8	4-3/8	32698	34895
3/4	1	4	3/4	1-3/4	32715	32740
3/4	1	6	3/4	2-3/8	32716	32741
3/4	1	6	3/4	3-3/8	32717	32742
3/4	1	6	3/4	4-3/8	32699	34896
1	1-1/4	6	1	2-3/8	32718	32743
1	1-1/4	6	1	3-3/8	32719	32744
1	1-1/4	7	1	4-3/8	32720	32745

TOLERANCES (inch)

1/8–3/16 DIAMETER

D₁ = +0.0000/–0.00032

D₂ = h₆

1/4–3/8 DIAMETER

D₁ = +0.0000/–0.00035

D₂ = h₆

1/2–5/8 DIAMETER

D₁ = +0.0000/–0.00043

D₂ = h₆

3/4–1 DIAMETER

D₁ = +0.0000/–0.00051

D₂ = h₆

NON-FERROUS

PLASTICS/COMPOSITES

For patent information visit www.ksptpatents.com

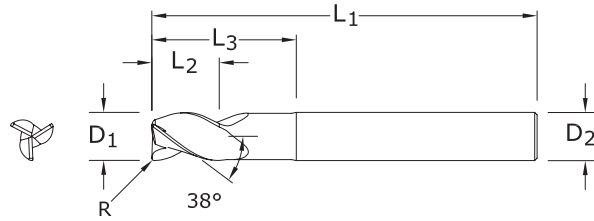
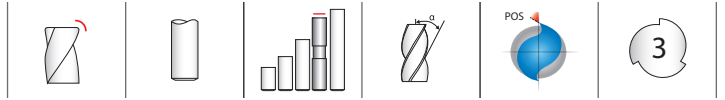

43LC
FRACTIONAL SERIES

TOLERANCES (inch)

1/8–3/16 DIAMETER

D₁ = +0.0000/–0.00032

D₂ = h₆

R = +0.0000/–0.0020

1/4–3/8 DIAMETER

D₁ = +0.0000/–0.00035

D₂ = h₆

R = +0.0000/–0.0020

1/2–5/8 DIAMETER

D₁ = +0.0000/–0.00043

D₂ = h₆

R = +0.0000/–0.0020

3/4–1 DIAMETER

D₁ = +0.0000/–0.00051

D₂ = h₆

R = +0.0000/–0.0020

NON-FERROUS

PLASTICS/COMPOSITES

For patent information visit www.ksptpatents.com

inch						EDP NO.	
CUTTING DIAMETER D ₁	LENGTH OF CUT L ₂	OVERALL LENGTH L ₁	SHANK DIAMETER D ₂	REACH L ₃	CORNER RADIUS R	UNCOATED	Ti-NAMITE-B (TiB ₂)
1/8	5/32	3	1/8	1/2	.010	32751	32815
3/16	7/32	3	3/16	1/2	.010	32752	32816
1/4	3/8	2-1/2	1/4	3/4	.015	35787	36235
1/4	3/8	2-1/2	1/4	3/4	.060	35788	36236
1/4	3/8	4	1/4	3/4	.010	32753	32817
1/4	3/8	4	1/4	3/4	.030	32754	32818
1/4	3/8	4	1/4	1-1/2	.010	32755	32819
1/4	3/8	4	1/4	1-1/2	.030	32756	32820
1/4	3/8	4	1/4	2-1/8	.010	32757	32821
1/4	3/8	4	1/4	2-1/8	.030	32758	32822
5/16	7/16	4	5/16	1-1/8	.030	32759	32823
5/16	7/16	4	5/16	2-1/8	.030	32760	32824
3/8	1/2	3	3/8	1-1/8	.015	35791	36239
3/8	1/2	3	3/8	1-1/8	.090	35792	36240
3/8	1/2	4	3/8	1-1/8	.030	32762	32826
3/8	1/2	4	3/8	1-1/8	.060	32763	32827
3/8	1/2	4	3/8	2-1/8	.030	32764	32828
3/8	1/2	4	3/8	2-1/8	.060	32765	32829
1/2	5/8	3	1/2	1-3/8	.015	35795	36243
1/2	5/8	4	1/2	1-3/8	.030	32767	32831
1/2	5/8	4	1/2	1-3/8	.060	32768	32832
1/2	5/8	4	1/2	1-3/8	.090	32769	32833
1/2	5/8	4	1/2	1-3/8	.120	32770	32834
1/2	5/8	4	1/2	2-1/4	.015	35796	36244
1/2	5/8	6	1/2	2-1/8	.030	32771	32835
1/2	5/8	6	1/2	2-1/8	.060	32772	32836
1/2	5/8	6	1/2	2-1/8	.090	32773	32837
1/2	5/8	6	1/2	2-1/8	.120	32774	32838
1/2	5/8	6	1/2	3-3/8	.030	32775	32839
1/2	5/8	6	1/2	3-3/8	.060	32776	32840
1/2	5/8	6	1/2	3-3/8	.090	32777	32841
1/2	5/8	6	1/2	3-3/8	.120	32778	32842
5/8	3/4	4	5/8	1-3/4	.030	32779	32843
5/8	3/4	4	5/8	1-3/4	.060	32780	32844
5/8	3/4	4	5/8	1-3/4	.090	32781	32845
5/8	3/4	4	5/8	1-3/4	.120	32782	32846
5/8	3/4	4	5/8	2-3/8	.030	32783	32847
5/8	3/4	4	5/8	2-3/8	.060	32784	32848

continued on next page

- Circular land allows for increased control at various speed and feed rates and reduces chatter
- Symmetrical end gashing for excellent balance at high speeds and aggressive plunging capability
- Open fluting for deep slotting and profiling
- Necked design with blended diameter transitions provide clearance to reach
- Enhanced corner geometry with tight tolerance corner radii
- Recommended for materials ≤ 150 Bhn (≤ 7 HRC)

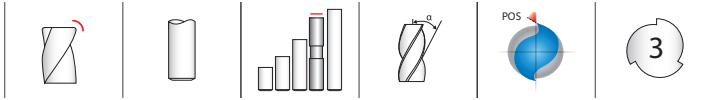

43LC
FRACTIONAL SERIES

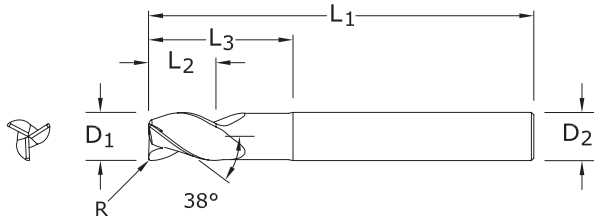

CONTINUED

CUTTING DIAMETER D ₁	LENGTH OF CUT L ₂	OVERALL LENGTH L ₁	inch			EDP NO.	
			SHANK DIAMETER D ₂	REACH L ₃	CORNER RADIUS R	UNCOATED	Ti-NAMITE-B (TiB ₂)
5/8	3/4	4	5/8	2-3/8	.090	32785	32849
5/8	3/4	4	5/8	2-3/8	.120	32786	32850
5/8	3/4	6	5/8	3-3/8	.030	32787	32851
5/8	3/4	6	5/8	3-3/8	.060	32788	32852
5/8	3/4	6	5/8	3-3/8	.090	32789	32853
5/8	3/4	6	5/8	3-3/8	.120	32790	32854
3/4	1	4	3/4	1-3/4	.030	32791	32855
3/4	1	4	3/4	1-3/4	.060	32792	32856
3/4	1	4	3/4	1-3/4	.090	32793	32857
3/4	1	4	3/4	1-3/4	.120	32794	32858
3/4	1	4	3/4	2	.190	35803	36251
3/4	1	4	3/4	2	.250	35804	36252
3/4	1	6	3/4	2-3/8	.030	32795	32859
3/4	1	6	3/4	2-3/8	.060	32796	32860
3/4	1	6	3/4	2-3/8	.090	32797	32861
3/4	1	6	3/4	2-3/8	.120	32798	32862
3/4	1	6	3/4	3-3/8	.030	32799	32863
3/4	1	6	3/4	3-3/8	.060	32800	32864
3/4	1	6	3/4	3-3/8	.090	32801	32865
3/4	1	6	3/4	3-3/8	.120	32802	32866
1	1-1/4	5	1	2-5/8	.190	35809	36257
1	1-1/4	5	1	2-5/8	.250	35810	36258
1	1-1/4	6	1	2-3/8	.030	32803	32867
1	1-1/4	6	1	2-3/8	.060	32804	32868
1	1-1/4	6	1	2-3/8	.090	32805	32869
1	1-1/4	6	1	2-3/8	.120	32806	32870
1	1-1/4	6	1	3-3/8	.030	32807	32871
1	1-1/4	6	1	3-3/8	.060	32808	32872
1	1-1/4	6	1	3-3/8	.090	32809	32873
1	1-1/4	6	1	3-3/8	.120	32810	32874
1	1-1/4	6	1	3-3/8	.190	35811	36259
1	1-1/4	6	1	3-3/8	.250	35812	36260

TOLERANCES (inch)

1/8–3/16 DIAMETER

D₁ = +0.0000/–0.00032

D₂ = h₆

R = +0.0000/–0.0020

1/4–3/8 DIAMETER

D₁ = +0.0000/–0.00035

D₂ = h₆

R = +0.0000/–0.0020

1/2–5/8 DIAMETER

D₁ = +0.0000/–0.00043

D₂ = h₆

R = +0.0000/–0.0020

3/4–1 DIAMETER

D₁ = +0.0000/–0.00051

D₂ = h₆

R = +0.0000/–0.0020

NON-FERROUS

PLASTICS/COMPOSITES

For patent information visit www.ksptpatents.com

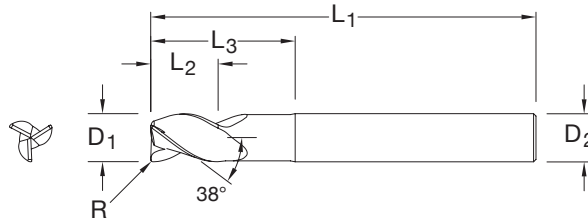
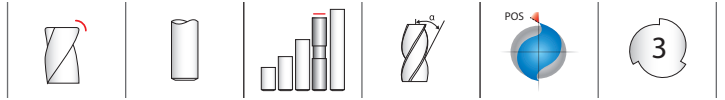

43EC
FRACTIONAL SERIES

TOLERANCES (inch)

1/4–3/8 DIAMETER

$D_1 = +0.0000/-0.00035$

$D_2 = h_6$

$R = +0.0000/-0.0020$

1/2–5/8 DIAMETER

$D_1 = +0.0000/-0.00043$

$D_2 = h_6$

$R = +0.0000/-0.0020$

3/4–1 DIAMETER

$D_1 = +0.0000/-0.00051$

$D_2 = h_6$

$R = +0.0000/-0.0020$

NON-FERROUS

PLASTICS/COMPOSITES

For patent information visit www.ksptpatents.com

CUTTING DIAMETER D_1	LENGTH OF CUT L_2	OVERALL LENGTH L_1	SHANK DIAMETER D_2	REACH L_3	CORNER RADIUS R	EDP NO.	
						UNCOATED	Ti-NAMITE-B (TiB ₂)
1/4	3/8	3	1/4	1-1/8	.015	35789	36237
1/4	3/8	3	1/4	1-1/8	.060	35790	36238
3/8	1/2	4	3/8	2-1/8	.015	35793	36241
3/8	1/2	4	3/8	2-1/8	.090	35794	36242
1/2	5/8	5	1/2	3-3/8	.015	35797	36245
1/2	5/8	6	1/2	4-1/4	.015	35798	36246
1/2	5/8	6	1/2	4-1/4	.030	35799	36247
1/2	5/8	6	1/2	4-1/4	.060	35800	36248
1/2	5/8	6	1/2	4-1/4	.090	35801	36249
1/2	5/8	6	1/2	4-1/4	.120	35802	36250
3/4	1	6	3/4	3-3/8	.190	35805	36253
3/4	1	6	3/4	3-3/8	.250	35806	36254
1	1-1/4	7	1	4-3/8	.030	35813	36261
1	1-1/4	7	1	4-3/8	.060	35814	36262
1	1-1/4	7	1	4-3/8	.090	35815	36263
1	1-1/4	7	1	4-3/8	.120	35816	36264
1	1-1/4	7	1	4-3/8	.190	35817	36265
1	1-1/4	7	1	4-3/8	.250	35818	36266

- Circular land allows for increased control at various speed and feed rates and reduces chatter
- Symmetrical end gashing for excellent balance at high speeds and aggressive plunging capability
- Open fluting for deep slotting and profiling
- Necked design with blended diameter transitions provide clearance to reach
- Enhanced corner geometry with tight tolerance corner radii
- Recommended for materials ≤ 150 Bhn (≤ 7 HRC)



43B

FRACTIONAL SERIES

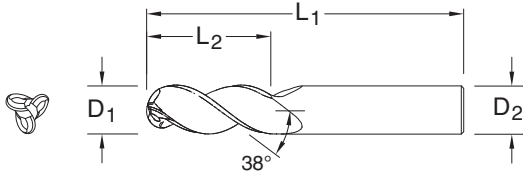

- Circular land allows for increased control at various speed and feed rates and reduces chatter
- Open fluting for deep slotting and profiling
- Ball nose design ideal for finishing operations in complex workpieces
- Recommended for materials ≤ 150 Bhn (≤ 7 HRC)

CUTTING DIAMETER D_1	LENGTH OF CUT L_2	OVERALL LENGTH L_1	SHANK DIAMETER D_2	inch		EDP NO.	
				UNCOATED	Ti-NAMITE-B (TiB ₂)		
1/4	3/8	2	1/4	34916	34972		
1/4	3/4	2-1/2	1/4	34917	34973		
1/4	1	3	1/4	34918	34974		
3/8	1/2	2	3/8	34919	34975		
3/8	1	2-1/2	3/8	34920	34976		
3/8	1-1/2	3-1/2	3/8	34921	34977		
1/2	5/8	2-1/2	1/2	34922	34978		
1/2	1	3	1/2	34923	34979		
1/2	1-1/4	3	1/2	34924	34980		
1/2	1-5/8	4	1/2	34925	34981		
1/2	2	4	1/2	34926	34982		
5/8	3/4	3	5/8	34927	34983		
5/8	1-5/8	4	5/8	34928	34984		
3/4	1	3	3/4	34929	34985		
3/4	1-5/8	4	3/4	34930	34986		
3/4	2-1/4	5	3/4	34931	34987		
1	1-1/4	4	1	34932	34988		
1	2	5	1	34933	34989		
1	3-1/4	6	1	34934	34990		

TOLERANCES (inch)

1/4–3/8 DIAMETER

$D_1 = +0.0000/-0.00035$

$D_2 = h_6$

BALL RADIUS

$+0.0005/-0.0005$

1/2–5/8 DIAMETER

$D_1 = +0.0000/-0.00043$

$D_2 = h_6$

BALL RADIUS

$+0.0005/-0.0005$

3/4–1 DIAMETER

$D_1 = +0.0000/-0.00051$

$D_2 = h_6$

BALL RADIUS

$+0.0005/-0.0005$

NON-FERROUS

PLASTICS/COMPOSITES

For patent information visit www.ksptpatents.com

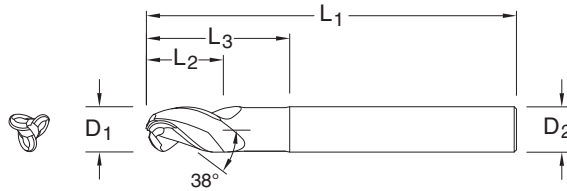
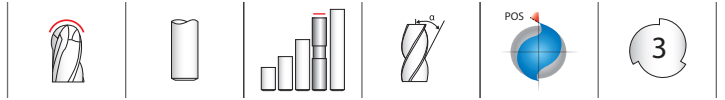

43LB
FRACTIONAL SERIES

TOLERANCES (inch)

1/4–3/8 DIAMETER

$D_1 = +0.0000/-0.00035$

$D_2 = h_6$

BALL RADIUS

$+0.0005/-0.0005$

1/2–5/8 DIAMETER

$D_1 = +0.0000/-0.00043$

$D_2 = h_6$

BALL RADIUS

$+0.0005/-0.0005$

3/4–1 DIAMETER

$D_1 = +0.0000/-0.00051$

$D_2 = h_6$

BALL RADIUS

$+0.0005/-0.0005$

NON-FERROUS

PLASTICS/COMPOSITES

For patent information visit www.ksptpatents.com

CUTTING DIAMETER D_1	LENGTH OF CUT L_2	OVERALL LENGTH L_1	SHANK DIAMETER D_2	REACH L_3	EDP NO.	
					UNCOATED	Ti-NAMITE-B (TiB ₂)
1/4	3/8	2-1/2	1/4	3/4	34941	35005
3/8	1/2	3	3/8	1-1/8	34943	35007
1/2	5/8	3	1/2	1-3/8	34945	35009
1/2	5/8	4	1/2	2-1/4	34946	35010
5/8	3/4	4	5/8	1-5/8	34949	35013
3/4	1	4	3/4	2	34951	35015
1	1-1/4	5	1	2-5/8	34954	35018
1	1-1/4	6	1	3-3/8	34955	35019

- Circular land allows for increased control at various speed and feed rates and reduces chatter
- Open fluting for deep slotting and profiling
- Necked design with blended diameter transitions provide clearance to reach
- Ball nose design ideal for finishing operations in complex workpieces
- Recommended for materials ≤ 150 Bhn (≤ 7 HRC)

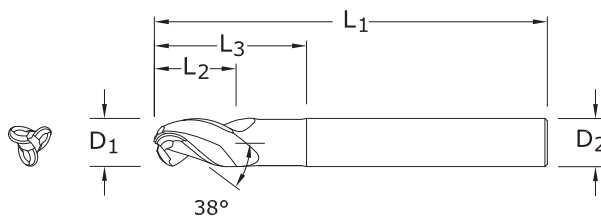
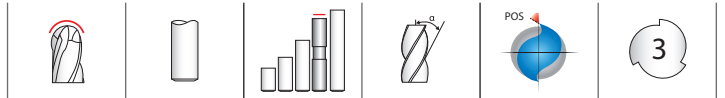

43EB
FRACTIONAL SERIES

TOLERANCES (inch)

1/4–3/8 DIAMETER

$D_1 = +0.0000/-0.00035$

$D_2 = h_6$

BALL RADIUS

$+0.0005/-0.0005$

1/2–5/8 DIAMETER

$D_1 = +0.0000/-0.00043$

$D_2 = h_6$

BALL RADIUS

$+0.0005/-0.0005$

3/4–1 DIAMETER

$D_1 = +0.0000/-0.00051$

$D_2 = h_6$

BALL RADIUS

$+0.0005/-0.0005$

NON-FERROUS

PLASTICS/COMPOSITES

For patent information visit www.ksptpatents.com

CUTTING DIAMETER D_1	LENGTH OF CUT L_2	OVERALL LENGTH L_1	SHANK DIAMETER D_2	REACH L_3	EDP NO.	
					UNCOATED	Ti-NAMITE-B (TiB ₂)
1/4	3/8	3	1/4	1-1/8	34942	35006
3/8	1/2	4	3/8	2-1/8	34944	35008
1/2	5/8	5	1/2	3-3/8	34947	35011
1/2	5/8	6	1/2	4-1/4	34948	35012
5/8	3/4	6	5/8	3-3/8	34950	35014
3/4	1	6	3/4	3-3/8	34952	35016
1	1-1/4	7	1	4-3/8	34956	35020

- Circular land allows for increased control at various speed and feed rates and reduces chatter
- Open fluting for deep slotting and profiling
- Necked design with blended diameter transitions provide clearance to reach
- Ball nose design ideal for finishing operations in complex workpieces
- Recommended for materials ≤ 150 Bhn (≤ 7 HRC)



43CB
FRACTIONAL SERIES

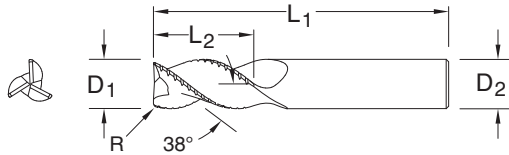

- Circular land allows for increased control at various speed and feed rates and reduces chatter
- Symmetrical end gashing for excellent balance at high speeds and aggressive plunging capability
- Chip breakers reduce machine loads up to 15% for increased roughing feed rate capability
- Open fluting for deep slotting and profiling
- Recommended for materials ≤ 150 Bhn (≤ 7 HRC)

CUTTING DIAMETER D ₁	LENGTH OF CUT L ₂	inch			EDP NO.	
		OVERALL LENGTH L ₁	SHANK DIAMETER D ₂	CORNER RADIUS R	UNCOATED	Ti-NAMITE-B (TiB ₂)
1/4	3/8	2-1/2	1/4	.020	33390	33450
1/4	1/2	2-1/2	1/4	.020	33391	33451
1/4	3/4	2-1/2	1/4	.020	33392	33452
1/4	1	3	1/4	.020	33393	33453
1/4	1-1/4	3-1/2	1/4	.020	33394	33454
1/4	1-3/4	4	1/4	.020	33395	33455
5/16	7/16	2-1/2	5/16	.020	33396	33456
5/16	11/16	2-1/2	5/16	.020	33397	33457
5/16	1	3	5/16	.020	33398	33458
5/16	2-1/8	4	5/16	.020	33400	33460
3/8	1/2	3	3/8	.020	33401	33461
3/8	1	2-1/2	3/8	.020	33400	33405
3/8	1-1/4	3-1/2	3/8	.020	33402	33462
3/8	1-1/2	4	3/8	.020	33403	33463
3/8	2	4	3/8	.020	33404	33464
1/2	5/8	3	1/2	.030	33406	33466
1/2	1	3	1/2	.030	33407	33467
1/2	1-1/4	3-1/4	1/2	.030	33401	33406
1/2	1-5/8	4	1/2	.030	33408	33468
1/2	2	4	1/2	.030	33409	33469
1/2	2-1/2	5	1/2	.030	33410	33470
1/2	3-1/8	6	1/2	.030	33411	33471
5/8	3/4	3-1/2	5/8	.030	33412	33472
5/8	1-5/8	3-3/4	5/8	.030	33402	33407
5/8	2-1/8	4	5/8	.030	33413	33473
5/8	3-1/4	6	5/8	.030	33415	33475
5/8	3-3/4	6	5/8	.030	33416	33476
3/4	1	4	3/4	.030	33417	33477
3/4	1-5/8	4	3/4	.030	33403	33408
3/4	2-1/4	4	3/4	.030	33418	33478
3/4	3-1/4	6	3/4	.030	33419	33479
3/4	4	6	3/4	.030	33420	33480
1	1-1/4	5	1	.030	33421	33481
1	2	4-1/2	1	.030	33404	33409
1	2-5/8	6	1	.030	33422	33482
1	3-1/4	6	1	.030	33423	33483
1	4-1/8	7	1	.030	33424	33484

TOLERANCES (inch)

1/4–3/8 DIAMETER

D₁ = +0.0000/–0.00035

D₂ = h₆

R = +0.0000/–0.0020

1/2–5/8 DIAMETER

D₁ = +0.0000/–0.00043

D₂ = h₆

R = +0.0000/–0.0020

3/4–1 DIAMETER

D₁ = +0.0000/–0.00051

D₂ = h₆

R = +0.0000/–0.0020

NON-FERROUS

PLASTICS/COMPOSITES

For patent information visit www.ksptpatents.com

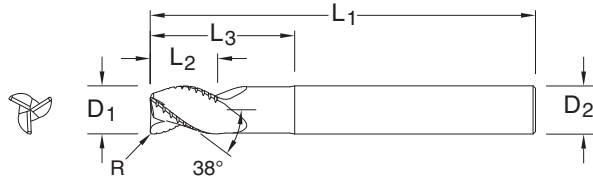

43LCB
FRACTIONAL SERIES

TOLERANCES (inch)

1/4–3/8 DIAMETER

$D_1 = +0.0000/-0.00035$

$D_2 = h_6$

$R = +0.0000/-0.0020$

1/2–5/8 DIAMETER

$D_1 = +0.0000/-0.00043$

$D_2 = h_6$

$R = +0.0000/-0.0020$

3/4–1 DIAMETER

$D_1 = +0.0000/-0.00051$

$D_2 = h_6$

$R = +0.0000/-0.0020$

NON-FERROUS

PLASTICS/COMPOSITES

For patent information visit www.ksptpatents.com

CUTTING DIAMETER D_1	LENGTH OF CUT L_2	OVERALL LENGTH L_1	inch			EDP NO.	
			SHANK DIAMETER D_2	REACH L_3	CORNER RADIUS R	UNCOATED	Ti-NAMITE-B (TiB ₂)
1/4	3/8	4	1/4	3/4	.020	33500	33540
1/4	3/8	4	1/4	1-1/8	.020	33501	33541
1/4	3/8	4	1/4	2-1/8	.020	33502	33542
5/16	7/16	4	5/16	1-1/8	.020	33503	33543
5/16	7/16	4	5/16	2-1/8	.020	33504	33544
3/8	1/2	4	3/8	1-1/8	.020	33507	33547
3/8	1/2	4	3/8	2-1/8	.020	33508	33548
1/2	5/8	4	1/2	1-3/8	.030	33511	33551
1/2	5/8	4	1/2	2-1/4	.030	33512	33552
1/2	5/8	6	1/2	3-3/8	.030	33513	33553
1/2	5/8	6	1/2	4-1/4	.030	33514	33554
5/8	3/4	4	5/8	1-5/8	.030	33515	33555
5/8	3/4	6	5/8	2-3/8	.030	33516	33556
5/8	3/4	6	5/8	3-3/8	.030	33517	33557
5/8	3/4	6	5/8	4-3/8	.030	33518	33558
3/4	1	4	3/4	2	.030	33519	33559
3/4	1	6	3/4	2-1/2	.030	33520	33560
3/4	1	6	3/4	3-3/8	.030	33521	33561
3/4	1	6	3/4	4-3/8	.030	33522	33562
1	1-1/4	6	1	2-5/8	.030	33523	33563
1	1-1/4	6	1	3-3/8	.030	33524	33564
1	1-1/4	7	1	4-3/8	.030	33525	33565

- Circular land allows for increased control at various speed and feed rates and reduces chatter
- Symmetrical end gashing for excellent balance at high speeds and aggressive plunging capability
- Chip breakers reduce machine loads up to 15% for increased roughing feed rate capability
- Open fluting for deep slotting and profiling
- Necked design with blended diameter transitions provide clearance to reach
- Recommended for materials ≤ 150 Bhn (≤ 7 HRC)

Series
43CR, 43CB, 43LC,
43, 43L, 43LCB, 43B,
43LB, 43ELB, 43EC
Fractional

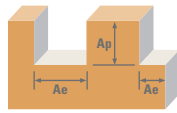

Material	Hardness	Ae x D ₁	Ap x D ₁	Vc (sfm)	Diameter (D ₁) (inch)							
					1/8	1/4	3/8	1/2	5/8	3/4	1	
ALUMINUM ALLOYS 2024, 5052, 5086, 6061, 6073, 7075	Slot 1 ≤ 1	1	≤ 1	1600	RPM	48896	24448	16299	12224	9779	8149	6112
				(1280-1920)	Fz	0.0009	0.0025	0.0045	0.0060	0.0065	0.0070	0.0085
					Feed (ipm)	132	183	220	220	191	171	156
	Profile ≤ 0.5 ≤ 1.5	≤ 0.5	≤ 1.5	2000	RPM	61120	30560	20373	15280	12224	10187	7640
				(1600-2400)	Fz	0.0009	0.0025	0.0045	0.0060	0.0065	0.0070	0.0085
					Feed (ipm)	165	229	275	275	238	214	195
	HSM ≤ 0.05 ≤ 2	≤ 0.05	≤ 2	3300	RPM	100848	50424	33616	25212	20170	16808	12606
				(2640-3960)	Fz	0.0021	0.0055	0.0105	0.0140	0.0150	0.0165	0.0195
					Feed (ipm)	635	832	1059	1059	908	832	737
ALUMINUM DIE CAST ALLOYS (HIGH SILICONE) A-390, A-392, B-390	Slot 1 ≤ 1	1	≤ 1	600	RPM	18336	9168	6112	4584	3667	3056	2292
				(480-720)	Fz	0.0009	0.0025	0.0045	0.0060	0.0065	0.0070	0.0085
					Feed (ipm)	50	69	83	83	72	64	58
	Profile ≤ 0.5 ≤ 1.5	≤ 0.5	≤ 1.5	750	RPM	22920	11460	7640	5730	4584	3820	2865
				(600-900)	Fz	0.0009	0.0025	0.0045	0.0060	0.0065	0.0070	0.0085
					Feed (ipm)	62	86	103	103	89	80	73
	HSM ≤ 0.05 ≤ 2	≤ 0.05	≤ 2	1240	RPM	37894	18947	12631	9474	7579	6316	4737
				(992-1488)	Fz	0.0021	0.0055	0.0105	0.0140	0.0150	0.0165	0.0195
					Feed (ipm)	239	313	398	398	341	313	277
COPPER ALLOYS Aluminum Bronze Brass Naval Brass Red Brass	Slot 1 ≤ 1	1	≤ 1	865	RPM	26434	13217	8811	6609	5287	4406	3304
				(692-1038)	Fz	0.0008	0.0020	0.0040	0.0050	0.0055	0.0060	0.0070
					Feed (ipm)	63	79	106	99	87	79	69
	Profile ≤ 0.5 ≤ 1.5	≤ 0.5	≤ 1.5	1080	RPM	33005	16502	11002	8251	6601	5501	4126
				(864-1296)	Fz	0.0008	0.0020	0.0040	0.0050	0.0055	0.0060	0.0070
					Feed (ipm)	79	99	132	124	109	99	87
	HSM ≤ 0.05 ≤ 2	≤ 0.05	≤ 2	1780	RPM	54397	27198	18132	13599	10879	9066	6800
				(1424-2136)	Fz	0.0017	0.0045	0.0085	0.0115	0.0125	0.0140	0.0160
					Feed (ipm)	277	367	462	469	408	381	326
COPPER ALLOYS Beryllium Copper C110, Malleable Bronze, Tin Bronze	Slot 1 ≤ 1	1	≤ 1	345	RPM	10543	5272	3514	2636	2109	1757	1318
				(276-414)	Fz	0.0008	0.0020	0.0040	0.0050	0.0055	0.0060	0.0070
					Feed (ipm)	25	32	42	40	35	32	28
	Profile ≤ 0.5 ≤ 1.5	≤ 0.5	≤ 1.5	430	RPM	13141	6570	4380	3285	2628	2190	1643
				(344-516)	Fz	0.0008	0.0020	0.0040	0.0050	0.0055	0.0060	0.0070
					Feed (ipm)	32	39	53	49	43	39	34
	HSM ≤ 0.05 ≤ 2	≤ 0.05	≤ 2	710	RPM	21698	10849	7233	5424	4340	3616	2712
				(568-852)	Fz	0.0017	0.0045	0.0085	0.0115	0.0125	0.0140	0.0160
					Feed (ipm)	111	146	184	187	163	152	130
PLASTICS ABS, Polycarbonate, PVC, Polypropylene	Slot 1 ≤ 1	1	≤ 1	1600	RPM	48896	24448	16299	12224	9779	8149	6112
				(1280-1920)	Fz	0.0015	0.0040	0.0075	0.0100	0.0110	0.0120	0.0140
					Feed (ipm)	220	293	367	367	323	293	257
	Profile ≤ 0.5 ≤ 1.5	≤ 0.5	≤ 1.5	2000	RPM	61120	30560	20373	15280	12224	10187	7640
				(1600-2400)	Fz	0.0015	0.0040	0.0075	0.0100	0.0110	0.0120	0.0140
					Feed (ipm)	275	367	458	458	403	367	321
	HSM ≤ 0.05 ≤ 2	≤ 0.05	≤ 2	3300	RPM	100848	50424	33616	25212	20170	16808	12606
				(2640-3960)	Fz	0.0034	0.0090	0.0170	0.0230	0.0250	0.0275	0.0320
					Feed (ipm)	1029	1361	1714	1740	1513	1387	1210

Bhn (Brinell) HRC (Rockwell C) HRB (Rockwell B) HSM (High Speed Machining)
 $rpm = Vc \times 3.82 / D_1$
 $ipm = Fz \times 3 \times rpm$
 reduce speed and feed for materials harder than listed
 reduce cut depth and feed by 50% for long flute and long reach tools
 reduce feed and Ae when finish milling (.02 x D₁ maximum)
 refer to the KYOCERA SGS Tool Wizard® for complete technical information (www.kyocera-sgstool.com)

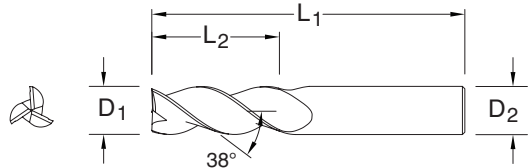
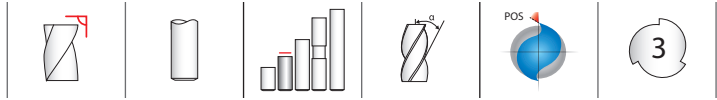

43M
METRIC SERIES

TOLERANCES (mm)

6 DIAMETER

$D_1 = +0,000/-0,008$
 $D_2 = h_6$

>6-10 DIAMETER

$D_1 = +0,000/-0,009$
 $D_2 = h_6$

>10-18 DIAMETER

$D_1 = +0,000/-0,011$
 $D_2 = h_6$

>18-25 DIAMETER

$D_1 = +0,000/-0,013$
 $D_2 = h_6$

NON-FERROUS

PLASTICS/COMPOSITES

For patent information visit www.ksptpatents.com

mm				EDP NO.	
CUTTING DIAMETER D_1	LENGTH OF CUT L_2	OVERALL LENGTH L_1	SHANK DIAMETER D_2	UNCOATED	Ti-NAMITE-B (TiB ₂)
6,0	13,0	57,0	6,0	44701	44715
6,0	13,0	72,0	6,0	44702	44716
8,0	19,0	63,0	8,0	44703	44717
10,0	22,0	72,0	10,0	44705	44719
12,0	26,0	83,0	12,0	44708	44722
16,0	32,0	92,0	16,0	44711	44725
20,0	38,0	104,0	20,0	44714	44728
25,0	50,0	125,0	25,0	-	44731

- Circular land allows for increased control at various speed and feed rates and reduces chatter
- Symmetrical end gashing for excellent balance at high speeds and aggressive plunging capability
- Open fluting for deep slotting and profiling
- Recommended for materials ≤ 150 Bhn (≤ 7 HRC)

TOLERANCES (mm)

3 DIAMETER

$D_1 = +0,000/-0,006$
 $D_2 = h_6$

>3-6 DIAMETER

$D_1 = +0,000/-0,008$
 $D_2 = h_6$

>6-10 DIAMETER

$D_1 = +0,000/-0,009$
 $D_2 = h_6$

>10-18 DIAMETER

$D_1 = +0,000/-0,011$
 $D_2 = h_6$

>18-20 DIAMETER

$D_1 = +0,000/-0,013$
 $D_2 = h_6$

NON-FERROUS

PLASTICS/COMPOSITES

For patent information visit www.ksptpatents.com

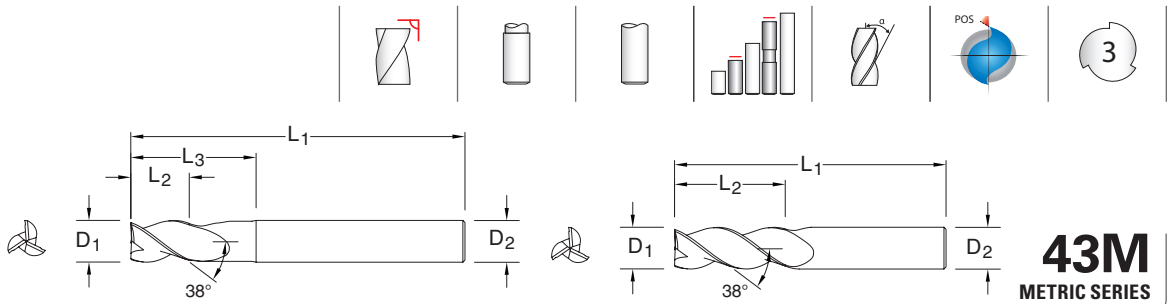

43M
METRIC SERIES

mm						EDP NO.	
CUTTING DIAMETER D_1	LENGTH OF CUT L_2	OVERALL LENGTH L_1	SHANK DIAMETER D_2	REACH L_3	POLISHED FLUTE	Ti-NAMITE-B (TiB ₂)	
3,0	8,0	52,0	6,0	-	•	44890	
4,0	11,0	55,0	6,0	-	•	44891	
5,0	13,0	57,0	6,0	-	•	44892	
6,0	24,0	75,0	6,0	-	•	44893	
8,0	32,0	75,0	8,0	-	•	44895	
10,0	40,0	100,0	10,0	-	•	44896	
12,0	48,0	100,0	12,0	-	•	44897	
14,0	30,0	89,0	14,0	-	•	44898	
14,0	18,0	125,0	14,0	45,0	•	44899	
16,0	64,0	125,0	16,0	-	•	44900	
20,0	80,0	150,0	20,0	-	•	44901	

- Circular land allows for increased control at various speed and feed rates and reduces chatter
- Symmetrical end gashing for excellent balance at high speeds and aggressive plunging capability
- Open fluting for deep slotting and profiling
- Polished flutes maximize chip evacuation and provides enhanced finish
- Recommended for materials ≤ 150 Bhn (≤ 7 HRC)

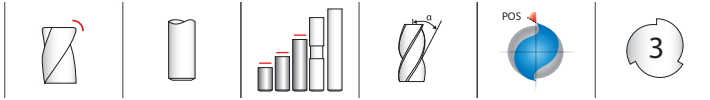

43MCR
METRIC SERIES

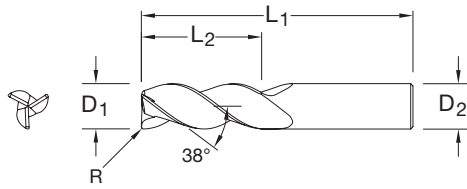

- Circular land allows for increased control at various speed and feed rates and reduces chatter
- Symmetrical end gashing for excellent balance at high speeds and aggressive plunging capability
- Open fluting for deep slotting and profiling
- Enhanced corner geometry with tight tolerance corner radii
- Recommended for materials ≤ 150 Bhn (≤ 7 HRC)

CUTTING DIAMETER D ₁	LENGTH OF CUT L ₂	mm			EDP NO.	
		OVERALL LENGTH L ₁	SHANK DIAMETER D ₂	CORNER RADIUS R	UNCOATED	Ti-NAMITE-B (TiB ₂)
6,0	13,0	57,0	6,0	1,5	—	44732
12,0	26,0	83,0	12,0	1,5	44814	44733
12,0	26,0	83,0	12,0	2,0	44815	44826
12,0	26,0	83,0	12,0	2,5	44816	44827
12,0	26,0	83,0	12,0	3,0	44817	44734
16,0	32,0	92,0	16,0	1,5	44818	44735
16,0	32,0	92,0	16,0	2,0	44819	44828
16,0	32,0	92,0	16,0	2,5	44820	44829
16,0	32,0	92,0	16,0	3,0	44821	44736
20,0	38,0	104,0	20,0	2,0	44822	44830
20,0	38,0	104,0	20,0	2,5	44823	44831
20,0	38,0	104,0	20,0	3,0	44824	44737

TOLERANCES (mm)

6 DIAMETER

D₁ = +0,000/-0,008

D₂ = h₆

R = +0,00/-0,05

>6-10 DIAMETER

D₁ = +0,000/-0,009

D₂ = h₆

R = +0,00/-0,05

>10-18 DIAMETER

D₁ = +0,000/-0,011

D₂ = h₆

R = +0,00/-0,05

>18-20 DIAMETER

D₁ = +0,000/-0,013

D₂ = h₆

R = +0,00/-0,05

NON-FERROUS

PLASTICS/COMPOSITES

For patent information visit www.ksptpatents.com

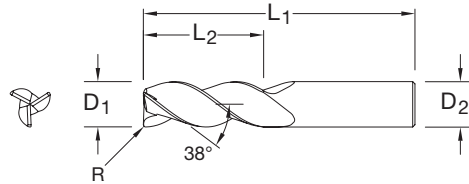
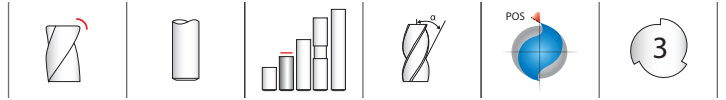

43MCR

METRIC SERIES

TOLERANCES (mm)

6 DIAMETER

$D_1 = +0,000/-0,008$

$D_2 = h_6$

$R = +0,00/-0,05$

>6-10 DIAMETER

$D_1 = +0,000/-0,009$

$D_2 = h_6$

$R = +0,00/-0,05$

>10-18 DIAMETER

$D_1 = +0,000/-0,011$

$D_2 = h_6$

$R = +0,00/-0,05$

>18-20 DIAMETER

$D_1 = +0,000/-0,013$

$D_2 = h_6$

$R = +0,00/-0,05$

NON-FERROUS

PLASTICS/COMPOSITES

For patent
information visit
www.ksptpatents.com

mm						EDP NO.
CUTTING DIAMETER D_1	LENGTH OF CUT L_2	OVERALL LENGTH L_1	SHANK DIAMETER D_2	CORNER RADIUS R	POLISHED FLUTE	Ti-NAMITE-B (TiB ₂)
6,0	13,0	57,0	6,0	0,5	•	44902
6,0	13,0	57,0	6,0	1,0	•	44894
6,0	13,0	72,0	6,0	0,8	•	44842
6,0	13,0	72,0	6,0	1,2	•	44843
8,0	19,0	63,0	8,0	0,3	•	44846
8,0	19,0	63,0	8,0	0,5	•	44847
8,0	19,0	63,0	8,0	1,0	•	44848
8,0	19,0	63,0	8,0	1,5	•	44849
10,0	22,0	72,0	10,0	0,3	•	44854
10,0	22,0	72,0	10,0	0,5	•	44855
10,0	22,0	72,0	10,0	1,0	•	44856
10,0	22,0	72,0	10,0	1,5	•	44857
14,0	30,0	89,0	14,0	1,0	•	44868
14,0	30,0	89,0	14,0	2,0	•	44869
14,0	30,0	89,0	14,0	3,0	•	44870
16,0	32,0	92,0	16,0	4,0	•	44871
20,0	38,0	104,0	20,0	4,0	•	44879

- Circular land allows for increased control at various speed and feed rates and reduces chatter
- Symmetrical end gashing for excellent balance at high speeds and aggressive plunging capability
- Open fluting for deep slotting and profiling
- Polished flutes maximize chip evacuation and provides enhanced finish
- Enhanced corner geometry with tight tolerance corner radii
- Recommended for materials ≤ 150 Bhn (≤ 7 HRC)

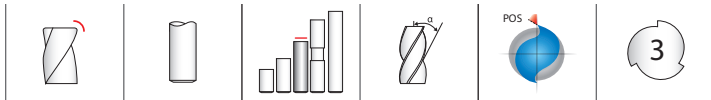

43MCR 4xD

METRIC SERIES

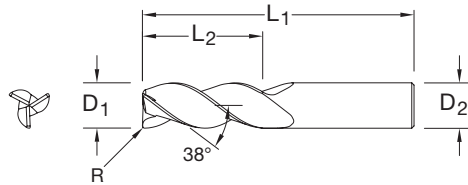

- Circular land allows for increased control at various speed and feed rates and reduces chatter
- Symmetrical end gashing for excellent balance at high speeds and aggressive plunging capability
- Open fluting for deep slotting and profiling
- Polished flutes maximize chip evacuation and provides enhanced finish
- Enhanced corner geometry with tight tolerance corner radii
- Recommended for materials ≤ 150 Bhn (≤ 7 HRC)

CUTTING DIAMETER D ₁	LENGTH OF CUT L ₂	OVERALL LENGTH L ₁	mm			POLISHED FLUTE	EDP NO. Ti-NAMITE-B (TiB ₂)
			SHANK DIAMETER D ₂	CORNER RADIUS R			
6,0	24,0	75,0	6,0	0,5	•	44844	
6,0	24,0	75,0	6,0	1,0	•	44845	
8,0	32,0	75,0	8,0	0,5	•	44850	
8,0	32,0	75,0	8,0	1,0	•	44851	
8,0	32,0	75,0	8,0	1,5	•	44852	
8,0	32,0	75,0	8,0	2,0	•	44853	
10,0	40,0	100,0	10,0	0,5	•	44858	
10,0	40,0	100,0	10,0	1,0	•	44859	
10,0	40,0	100,0	10,0	1,5	•	44860	
10,0	40,0	100,0	10,0	2,0	•	44861	
12,0	48,0	100,0	12,0	0,5	•	44862	
12,0	48,0	100,0	12,0	1,0	•	44863	
12,0	48,0	100,0	12,0	1,5	•	44864	
12,0	48,0	100,0	12,0	2,0	•	44865	
12,0	48,0	100,0	12,0	2,5	•	44866	
12,0	48,0	100,0	12,0	3,0	•	44867	
16,0	64,0	125,0	16,0	0,5	•	44872	
16,0	64,0	125,0	16,0	1,0	•	44873	
16,0	64,0	125,0	16,0	1,5	•	44874	
16,0	64,0	125,0	16,0	2,0	•	44875	
16,0	64,0	125,0	16,0	2,5	•	44876	
16,0	64,0	125,0	16,0	3,0	•	44877	
16,0	64,0	125,0	16,0	4,0	•	44878	
20,0	80,0	150,0	20,0	0,5	•	44880	
20,0	80,0	150,0	20,0	1,0	•	44881	
20,0	80,0	150,0	20,0	1,5	•	44882	
20,0	80,0	150,0	20,0	2,0	•	44883	
20,0	80,0	150,0	20,0	2,5	•	44884	
20,0	80,0	150,0	20,0	3,0	•	44885	
20,0	80,0	150,0	20,0	4,0	•	44886	

TOLERANCES (mm)

6 DIAMETER

D₁ = +0,000/-0,008

D₂ = h₆

R = +0,00/-0,05

>6-10 DIAMETER

D₁ = +0,000/-0,009

D₂ = h₆

R = +0,00/-0,05

>10-18 DIAMETER

D₁ = +0,000/-0,011

D₂ = h₆

R = +0,00/-0,05

>18-20 DIAMETER

D₁ = +0,000/-0,013

D₂ = h₆

R = +0,00/-0,05

NON-FERROUS

PLASTICS/COMPOSITES

For patent information visit www.ksptpatents.com

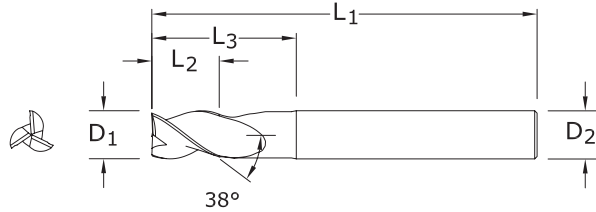
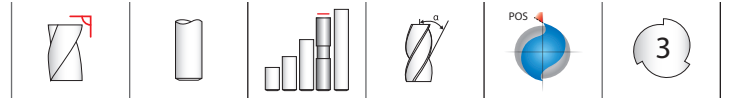

43ML
METRIC SERIES

TOLERANCES (mm)

6 DIAMETER

$D_1 = +0,000/-0,008$

$D_2 = h_6$

>6-10 DIAMETER

$D_1 = +0,000/-0,009$

$D_2 = h_6$

>10-18 DIAMETER

$D_1 = +0,000/-0,011$

$D_2 = h_6$

>18-20 DIAMETER

$D_1 = +0,000/-0,013$

$D_2 = h_6$

NON-FERROUS

PLASTICS/COMPOSITES

For patent information visit www.ksptpatents.com

mm					EDP NO.
CUTTING DIAMETER D_1	LENGTH OF CUT L_2	OVERALL LENGTH L_1	SHANK DIAMETER D_2	REACH L_3	Ti-NAMITE-B (TiB ₂)
6,0	10,0	75,0	6,0	20,0	42706
8,0	12,0	75,0	8,0	25,0	42707
10,0	14,0	100,0	10,0	35,0	42708
12,0	16,0	100,0	12,0	40,0	42709
16,0	20,0	125,0	16,0	50,0	42710
20,0	25,0	150,0	20,0	65,0	42711

- Circular land allows for increased control at various speed and feed rates and reduces chatter
- Symmetrical end gashing for excellent balance at high speeds and aggressive plunging capability
- Open fluting for deep slotting and profiling
- Necked design with blended diameter transitions provide clearance to reach
- Recommended for materials ≤ 150 Bhn (≤ 7 HRC)

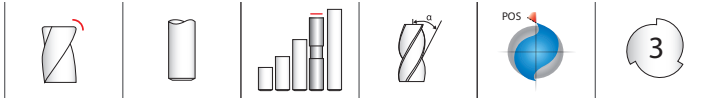

43MLC
METRIC SERIES

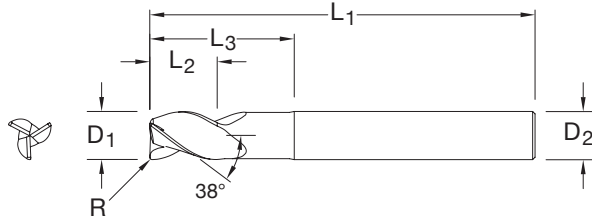

- Circular land allows for increased control at various speed and feed rates and reduces chatter
- Symmetrical end gashing for excellent balance at high speeds and aggressive plunging capability
- Open fluting for deep slotting and profiling
- Necked design with blended diameter transitions provide clearance to reach
- Enhanced corner geometry with tight tolerance corner radii
- Recommended for materials ≤ 150 Bhn (≤ 7 HRC)

CUTTING DIAMETER D ₁	LENGTH OF CUT L ₂	mm				CORNER RADIUS R	EDP NO.	
		OVERALL LENGTH L ₁	SHANK DIAMETER D ₂	REACH L ₃	UNCOATED		Ti-NAMITE-B (TiB ₂)	
6,0	10,0	63,0	6,0	20,0	0,5	44769	44789	
6,0	10,0	63,0	6,0	20,0	1,0	44770	44790	
6,0	13,0	72,0	6,0	30,0	0,5	44771	44791	
6,0	13,0	72,0	6,0	30,0	1,0	44772	44792	
8,0	12,0	75,0	8,0	25,0	0,3	44773	44793	
8,0	12,0	75,0	8,0	25,0	0,5	44774	44794	
8,0	12,0	75,0	8,0	25,0	1,0	44775	44795	
8,0	12,0	75,0	8,0	25,0	1,5	44776	44796	
10,0	14,0	100,0	10,0	35,0	0,3	44777	44797	
10,0	14,0	100,0	10,0	35,0	0,5	44778	44798	
10,0	14,0	100,0	10,0	35,0	1,0	44779	44799	
10,0	14,0	100,0	10,0	35,0	1,5	44780	44800	
12,0	16,0	100,0	12,0	40,0	0,5	44781	44801	
12,0	16,0	100,0	12,0	40,0	1,0	44782	44802	
12,0	16,0	100,0	12,0	40,0	1,5	44783	44803	
12,0	16,0	100,0	12,0	40,0	2,0	44784	44804	
12,0	16,0	100,0	12,0	40,0	2,5	44832	44839	
12,0	16,0	100,0	12,0	40,0	3,0	44833	44738	
12,0	16,0	100,0	12,0	40,0	4,0	44834	44741	
16,0	20,0	125,0	16,0	50,0	2,0	44785	44805	
16,0	20,0	125,0	16,0	50,0	2,5	44835	44840	
16,0	20,0	125,0	16,0	50,0	3,0	44836	44739	
16,0	20,0	125,0	16,0	50,0	4,0	44786	44806	
20,0	25,0	150,0	20,0	65,0	2,0	44787	44807	
20,0	25,0	150,0	20,0	65,0	2,5	44837	44841	
20,0	25,0	150,0	20,0	65,0	3,0	44838	44740	
20,0	25,0	150,0	20,0	65,0	4,0	44788	44808	

TOLERANCES (mm)

>6–10 DIAMETER

D₁ = +0,000/–0,009

D₂ = h₆

R = +0,00/–0,05

>10–18 DIAMETER

D₁ = +0,000/–0,011

D₂ = h₆

R = +0,00/–0,05

>18–20 DIAMETER

D₁ = +0,000/–0,013

D₂ = h₆

R = +0,00/–0,05

- NON-FERROUS
- PLASTICS/COMPOSITES

For patent information visit www.ksptpatents.com

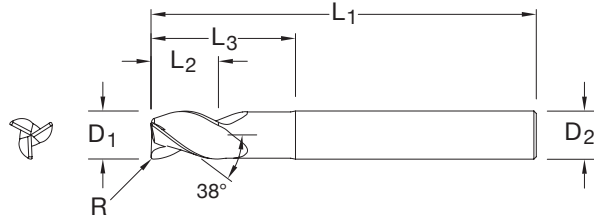
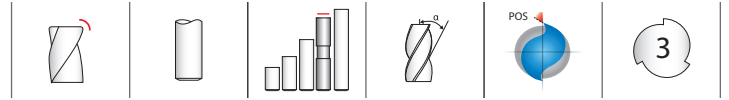

43MLC Aero Radius Range

METRIC SERIES

TOLERANCES (mm)

>6–10 DIAMETER

$D_1 = +0,000/-0,009$

$D_2 = h_6$

$R = +0,00/-0,05$

>10–18 DIAMETER

$D_1 = +0,000/-0,011$

$D_2 = h_6$

$R = +0,00/-0,05$

>18–20 DIAMETER

$D_1 = +0,000/-0,013$

$D_2 = h_6$

$R = +0,00/-0,05$

$D_1 = +0,000/-0,013$

$D_2 = h_6$

NON-FERROUS

PLASTICS/COMPOSITES

For patent information visit
www.ksptpatents.com

CUTTING DIAMETER D_1	LENGTH OF CUT L_2	OVERALL LENGTH L_1	mm				CORNER RADIUS R	POLISHED FLUTE	EDP NO. Ti-NAMITE-B (TiB ₂)
			SHANK DIAMETER D_2	REACH L_3					
8,0	12,0	75,0	8,0	25,0		0,8	•	44950	
8,0	12,0	75,0	8,0	25,0		1,2	•	44951	
8,0	12,0	75,0	8,0	25,0		1,6	•	44952	
10,0	14,0	100,0	10,0	35,0		0,8	•	44953	
10,0	14,0	100,0	10,0	35,0		1,2	•	44954	
10,0	14,0	100,0	10,0	35,0		1,6	•	44955	
10,0	14,0	100,0	10,0	35,0		2,4	•	44956	
12,0	16,0	100,0	12,0	40,0		0,8	•	44957	
12,0	16,0	100,0	12,0	40,0		1,2	•	44958	
12,0	16,0	100,0	12,0	40,0		1,6	•	44959	
12,0	16,0	100,0	12,0	40,0		2,4	•	44960	
14,0	18,0	125,0	14,0	45,0		1,0	•	44961	
14,0	18,0	125,0	14,0	45,0		2,0	•	44962	
14,0	18,0	125,0	14,0	45,0		3,0	•	44963	
14,0	18,0	125,0	14,0	45,0		4,0	•	44964	
16,0	20,0	125,0	16,0	50,0		0,8	•	44965	
16,0	20,0	125,0	16,0	50,0		1,2	•	44966	
16,0	20,0	125,0	16,0	50,0		1,6	•	44967	
16,0	20,0	125,0	16,0	50,0		2,4	•	44968	
16,0	20,0	125,0	16,0	50,0		3,2	•	44969	
20,0	25,0	150,0	20,0	65,0		0,8	•	44970	
20,0	25,0	150,0	20,0	65,0		1,2	•	44971	
20,0	25,0	150,0	20,0	65,0		1,6	•	44972	
20,0	25,0	150,0	20,0	65,0		2,4	•	44973	
20,0	25,0	150,0	20,0	65,0		3,2	•	44974	

- Circular land allows for increased control at various speed and feed rates and reduces chatter
- Symmetrical end gashing for excellent balance at high speeds and aggressive plunging capability
- Open fluting for deep slotting and profiling
- Polished flutes maximize chip evacuation and provides enhanced finish
- Necked design with blended diameter transitions provide clearance to reach
- Enhanced corner geometry with tight tolerance corner radii
- Recommended for materials ≤ 150 Bhn (≤ 7 HRC)

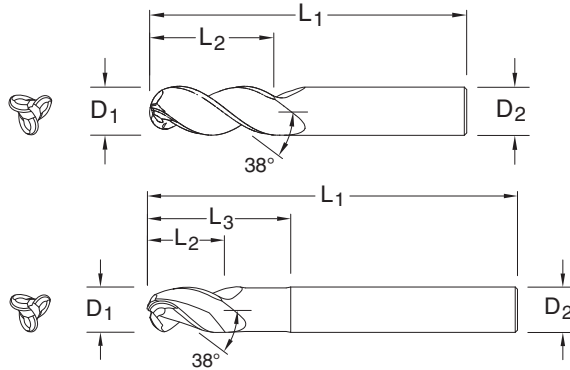
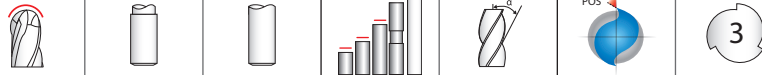

43MB
METRIC SERIES

- Circular land allows for increased control at various speed and feed rates and reduces chatter
- Open fluting for deep slotting and profiling
- Polished flutes maximize chip evacuation and provides enhanced finish
- Ball nose design ideal for finishing operations in complex workpieces
- Recommended for materials ≤ 150 Bhn (≤ 7 HRC)

mm						EDP NO.
CUTTING DIAMETER D ₁	LENGTH OF CUT L ₂	OVERALL LENGTH L ₁	SHANK DIAMETER D ₂	REACH L ₃	POLISHED FLUTE	Ti-NAMITE-B (TiB ₂)
3,0	4,5	57,0	6,0	—	•	44916
3,0	6,0	57,0	6,0	10,0	•	44917
3,0	9,0	57,0	6,0	16,0	•	44918
4,0	6,0	57,0	6,0	—	•	44919
4,0	8,0	57,0	6,0	13,0	•	44920
4,0	12,0	57,0	6,0	21,0	•	44921
5,0	7,5	57,0	6,0	—	•	44922
5,0	10,0	63,0	6,0	16,0	•	44923
5,0	15,0	63,0	6,0	26,0	•	44924
6,0	9,0	57,0	6,0	—	•	44925
6,0	12,0	63,0	6,0	19,0	•	44926
6,0	18,0	75,0	6,0	31,0	•	44927
8,0	12,0	63,0	8,0	—	•	44928
8,0	16,0	75,0	8,0	25,0	•	44929
8,0	24,0	83,0	8,0	41,0	•	44930
10,0	15,0	75,0	10,0	—	•	44931
10,0	20,0	83,0	10,0	31,0	•	44932
10,0	30,0	100,0	10,0	51,0	•	44933
12,0	18,0	83,0	12,0	—	•	44934
12,0	24,0	100,0	12,0	37,0	•	44935
12,0	36,0	130,0	12,0	61,0	•	44936
16,0	24,0	100,0	16,0	—	•	44937
16,0	32,0	130,0	16,0	49,0	•	44938
16,0	48,0	150,0	16,0	81,0	•	44939
20,0	30,0	108,0	20,0	—	•	44940
20,0	40,0	130,0	20,0	61,0	•	44941
20,0	60,0	150,0	20,0	101,0	•	44942
25,0	37,5	127,0	25,0	—	•	44943
25,0	50,0	152,0	25,0	76,0	•	44944
25,0	75,0	170,0	25,0	126,0	•	44945

TOLERANCES (mm)

3 DIAMETER

D₁ = +0,000/−0,006

D₂ = h₆

BALL RADIUS

+0,0127/−0,0127

>3–6 DIAMETER

D₁ = +0,000/−0,008

D₂ = h₆

BALL RADIUS

+0,0127/−0,0127

>6–10 DIAMETER

D₁ = +0,000/−0,009

D₂ = h₆

BALL RADIUS

+0,0127/−0,0127

>10–18 DIAMETER

D₁ = +0,000/−0,011

D₂ = h₆

BALL RADIUS

+0,0127/−0,0127

>18–25 DIAMETER

D₁ = +0,000/−0,013

D₂ = h₆

BALL RADIUS

+0,0127/−0,0127

NON-FERROUS

PLASTICS/COMPOSITES

For patent information visit www.ksptpatents.com

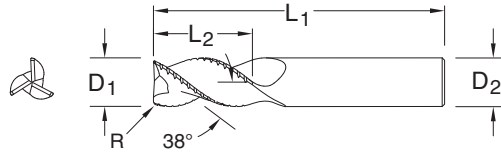

TOLERANCES (mm)

>6–10 DIAMETER

$D_1 = +0,000/-0,009$

$D_2 = h_6$

$R = +0,00/-0,05$

>10–18 DIAMETER

$D_1 = +0,000/-0,011$

$D_2 = h_6$

$R = +0,00/-0,05$

>18–20 DIAMETER

$D_1 = +0,000/-0,013$

$D_2 = h_6$

$R = +0,00/-0,05$

NON-FERROUS

PLASTICS/COMPOSITES

For patent information visit www.ksptpatents.com







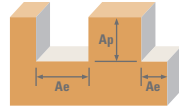

43MCB
METRIC SERIES

CUTTING DIAMETER D_1	LENGTH OF CUT L_2	OVERALL LENGTH L_1	SHANK DIAMETER D_2	CORNER RADIUS R	EDP NO.	
					UNCOATED	Ti-NAMITE-B (TiB ₂)
6,0	19,0	63,0	6,0	0,3	—	44299
8,0	19,0	63,0	8,0	0,3	44300	44305
10,0	22,0	72,0	10,0	0,3	44301	44306
12,0	26,0	83,0	12,0	1,0	44302	44307
16,0	32,0	92,0	16,0	1,0	44303	44308
20,0	38,0	104,0	20,0	1,0	44304	44309

- Circular land allows for increased control at various speed and feed rates and reduces chatter
- Symmetrical end gashing for excellent balance at high speeds and aggressive plunging capability
- Chip breakers reduce machine loads up to 15% for increased roughing feed rate capability
- Open fluting for deep slotting and profiling
- Recommended for materials ≤ 150 Bhn (≤ 7 HRc)

Series
43M, 43MB, 43MCR,
43ML, 43MLC,
43MCB
Metric



Material	Hardness	Ae x D ₁	Ap x D ₁	Vc (m/min)	Diameter (D ₁) (mm)								
					3	6	10	12	16	20	25		
ALUMINUM ALLOYS 2024, 5052, 5086, 6061, 6073, 7075	≤ 150 Bhn or ≤ 7 HRc	Slot 	1	≤ 1	490	RPM	52022	26011	15607	13005	9754	7803	6243
					(392-588)	Fz	0.022	0.060	0.120	0.144	0.166	0.187	0.213
					Feed (mm/min)	3371	4682	5618	5618	4869	4370	3980	
		Profile 	≤ 0.5	≤ 1.5	610	RPM	64762	32381	19429	16190	12143	9714	7771
					(488-732)	Fz	0.022	0.060	0.120	0.144	0.166	0.187	0.213
					Feed (mm/min)	4196	5828	6994	6994	6061	5440	4955	
		HSM 	≤ 0.05	≤ 2	1005	RPM	106698	53349	32009	26674	20006	16005	12804
					(804-1206)	Fz	0.050	0.132	0.280	0.336	0.384	0.440	0.488
					Feed (mm/min)	16131	21124	26888	26885	23046	21126	18726	
ALUMINUM DIE CAST ALLOYS (HIGH SILICONE) A-390, A-392, B-390	≤ 125 Bhn or ≤ 77 HRb	Slot 	1	≤ 1	185	RPM	19641	9820	5892	4910	3683	2946	2357
					(148-222)	Fz	0.022	0.060	0.120	0.144	0.166	0.187	0.213
					Feed (mm/min)	1273	1768	2121	2121	1838	1650	1503	
		Profile 	≤ 0.5	≤ 1.5	230	RPM	24418	12209	7326	6105	4578	3663	2930
					(184-276)	Fz	0.022	0.060	0.120	0.144	0.166	0.187	0.213
					Feed (mm/min)	1582	2197	2637	2637	2285	2051	1868	
		HSM 	≤ 0.05	≤ 2	380	RPM	40343	20172	12103	10086	7564	6052	4841
					(304-456)	Fz	0.050	0.132	0.280	0.336	0.384	0.440	0.488
					Feed (mm/min)	6099	7987	10166	10166	8714	7988	7081	
COPPER ALLOYS Aluminum Bronze Brass Naval Brass Red Brass	≤ 140 Bhn or ≤ 3 HRc	Slot 	1	≤ 1	265	RPM	28134	14067	8440	7034	5275	4220	3376
					(212-318)	Fz	0.019	0.048	0.107	0.120	0.141	0.160	0.175
					Feed (mm/min)	1620	2025	2701	2532	2228	2026	1773	
		Profile 	≤ 0.5	≤ 1.5	330	RPM	35035	17518	10511	8759	6569	5255	4204
					(264-396)	Fz	0.019	0.048	0.107	0.120	0.141	0.160	0.175
					Feed (mm/min)	2018	2522	3363	3153	2775	2523	2207	
		HSM 	≤ 0.05	≤ 2	545	RPM	57861	28930	17358	14465	10849	8679	6943
					(436-654)	Fz	0.041	0.108	0.227	0.276	0.320	0.373	0.400
					Feed (mm/min)	7082	9373	11804	11976	10415	9721	8332	
COPPER ALLOYS Beryllium Copper C110, Manganese Bronze, Tin Bronze	≤ 200 Bhn or ≤ 23 HRc	Slot 	1	≤ 1	105	RPM	11148	5574	3344	2787	2090	1672	1338
					(84-126)	Fz	0.019	0.048	0.107	0.120	0.141	0.160	0.175
					Feed (mm/min)	642	803	1070	1003	883	803	702	
		Profile 	≤ 0.5	≤ 1.5	130	RPM	13802	6901	4141	3450	2588	2070	1656
					(104-156)	Fz	0.019	0.048	0.107	0.120	0.141	0.160	0.175
					Feed (mm/min)	795	994	1325	1242	1093	994	870	
		HSM 	≤ 0.05	≤ 2	215	RPM	22826	11413	6848	5706	4280	3424	2739
					(172-258)	Fz	0.041	0.108	0.227	0.276	0.320	0.373	0.400
					Feed (mm/min)	2794	3697	4656	4725	4109	3835	3287	
PLASTICS ABS, Polycarbonate, PVC, Polypropylene		Slot 	1	≤ 1	490	RPM	52022	26011	15607	13005	9754	7803	6243
					(392-588)	Fz	0.036	0.096	0.200	0.240	0.282	0.320	0.350
					Feed (mm/min)	5618	7490	9364	9363	8240	7491	6555	
		Profile 	≤ 0.5	≤ 1.5	610	RPM	64762	32381	19429	16190	12143	9714	7771
					(488-732)	Fz	0.036	0.096	0.200	0.240	0.282	0.320	0.350
					Feed (mm/min)	6994	9325	11657	11656	10258	9326	8160	
		HSM 	≤ 0.05	≤ 2	1005	RPM	106698	53349	32009	26674	20006	16005	12804
					(804-1206)	Fz	0.082	0.216	0.453	0.552	0.640	0.733	0.800
					Feed (mm/min)	26117	34567	43532	44169	38410	35210	30730	

Bhn (Brinell) HRc (Rockwell C) HRb (Rockwell B) HSM (High Speed Machining)
 $rpm = (Vc \times 1000) / (D_1 \times 3.14)$
 $mm/min = Fz \times 3 \times rpm$
 reduce speed and feed for materials harder than listed
 reduce cut depth and feed by 50% for long flute and long reach tools
 reduce feed and Ae when finish milling (.02 x D₁ maximum)
 refer to the KYOCERA SGS Tool Wizard® for complete technical information (www.kyocera-sgstool.com)

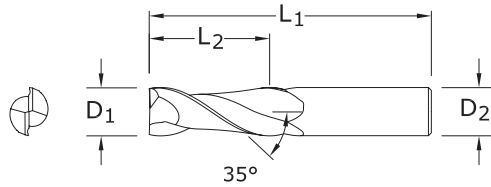
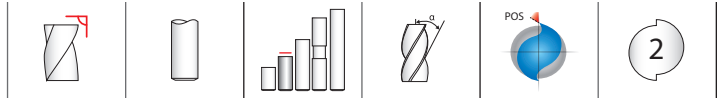

TOLERANCES (inch)

1/8–3/16 DIAMETER

$D_1 = +0.0000/-0.00032$

$D_2 = h_6$

1/4–3/8 DIAMETER

$D_1 = +0.0000/-0.00035$

$D_2 = h_6$

1/2–5/8 DIAMETER

$D_1 = +0.0000/-0.00043$

$D_2 = h_6$

3/4–1 DIAMETER

$D_1 = +0.0000/-0.00051$

$D_2 = h_6$

- NON-FERROUS
- PLASTICS/COMPOSITES

For patent information visit www.ksptpatents.com

47
FRACTIONAL SERIES

inch				EDP NO.	
CUTTING DIAMETER D_1	LENGTH OF CUT L_2	OVERALL LENGTH L_1	SHANK DIAMETER D_2	UNCOATED	Ti-NAMITE-B (TiB ₂)
1/8	3/8	1-1/2	1/8	34620	34660
3/16	9/16	2	3/16	34621	34661
1/4	3/4	2-1/2	1/4	34622	34662
5/16	13/16	2-1/2	5/16	34623	34663
3/8	1	2-1/2	3/8	34624	34664
1/2	1-1/4	3-1/4	1/2	34625	34665
5/8	1-5/8	3-3/4	5/8	34626	34666
3/4	1-5/8	4	3/4	34627	34667
1	2	4-1/2	1	34628	34668

- Circular land reduces edge aggressiveness for varied speed and feed rates
- 2 Flutes effectively manage the large size and volume of chips produced during the aggressive machining process
- Excellent balance at high speeds and aggressive plunging capability
- Recommended for materials ≤ 150 Bhn (≤ 7 HRc)

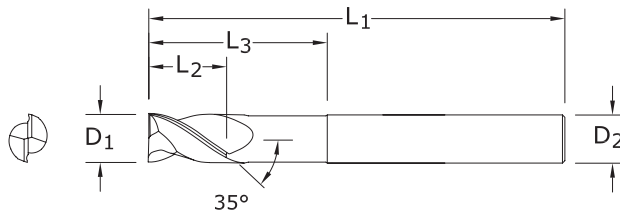
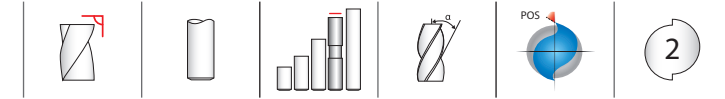

TOLERANCES (inch)

1/4–3/8 DIAMETER

$D_1 = +0.0000/-0.00035$

$D_2 = h_6$

1/2–5/8 DIAMETER

$D_1 = +0.0000/-0.00043$

$D_2 = h_6$

3/4–1 DIAMETER

$D_1 = +0.0000/-0.00051$

$D_2 = h_6$

- NON-FERROUS
- PLASTICS/COMPOSITES

For patent information visit www.ksptpatents.com

47L
FRACTIONAL SERIES

inch					EDP NO.	
CUTTING DIAMETER D_1	LENGTH OF CUT L_2	OVERALL LENGTH L_1	SHANK DIAMETER D_2	REACH L_3	UNCOATED	Ti-NAMITE-B (TiB ₂)
1/4	3/8	4	1/4	2-1/8	34640	34678
3/8	1/2	4	3/8	2-1/8	34641	34679
1/2	5/8	6	1/2	2-1/8	34642	34680
1/2	5/8	6	1/2	3-3/8	34643	34681
5/8	3/4	6	5/8	2-3/8	34644	34682
5/8	3/4	6	5/8	3-3/8	34645	34683
3/4	1	6	3/4	2-1/2	34646	34684
3/4	1	6	3/4	3-3/8	34647	34685

- Circular land reduces edge aggressiveness for varied speed and feed rates
- 2 Flutes effectively manage the large size and volume of chips produced during the aggressive machining process
- Excellent balance at high speeds and aggressive plunging capability
- Necked design with blended diameter transitions provide clearance to reach
- Recommended for materials ≤ 150 Bhn (≤ 7 HRc)

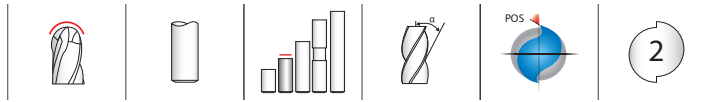

47B
FRACTIONAL SERIES

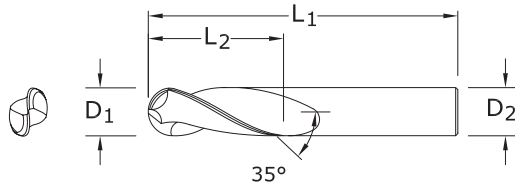

- Circular land reduces edge aggressiveness for varied speed and feed rates
- 2 Flutes effectively manage the large size and volume of chips produced during the aggressive machining process
- Excellent balance at high speeds and aggressive plunging capability
- Ball nose design ideal for finishing operations in complex workpieces
- Recommended for materials ≤ 150 Bhn (≤ 7 HRC)

CUTTING DIAMETER D_1	LENGTH OF CUT L_2	OVERALL LENGTH L_1	SHANK DIAMETER D_2	EDP NO.	
				UNCOATED	Ti-NAMITE-B (TiB ₂)
1/8	3/8	1-1/2	1/8	34630	34669
3/16	9/16	2	3/16	34631	34670
1/4	3/4	2-1/2	1/4	34632	34671
5/16	13/16	2-1/2	5/16	34633	34672
3/8	1	2-1/2	3/8	34634	34673
1/2	1-1/4	3-1/4	1/2	34635	34674
5/8	1-5/8	3-3/4	5/8	34636	34675
3/4	1-5/8	4	3/4	34637	34676
1	2	4-1/2	1	34638	34677

TOLERANCES (inch)

- 1/8–3/16 DIAMETER**
 $D_1 = +0.0000/-0.00032$
 $D_2 = h_6$
BALL RADIUS
 $+0.0005/-0.0005$
- 1/4–3/8 DIAMETER**
 $D_1 = +0.0000/-0.00035$
 $D_2 = h_6$
BALL RADIUS
 $+0.0005/-0.0005$
- 1/2–5/8 DIAMETER**
 $D_1 = +0.0000/-0.00043$
 $D_2 = h_6$
BALL RADIUS
 $+0.0005/-0.0005$
- 3/4–1 DIAMETER**
 $D_1 = +0.0000/-0.00051$
 $D_2 = h_6$
BALL RADIUS
 $+0.0005/-0.0005$

- NON-FERROUS
- PLASTICS/COMPOSITES

For patent information visit www.ksptpatents.com

47LB
FRACTIONAL SERIES

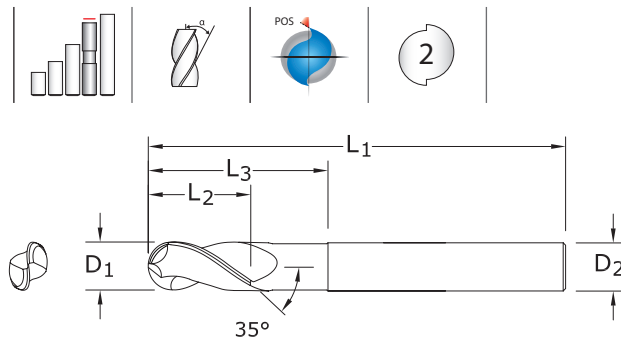

- Circular land reduces edge aggressiveness for varied speed and feed rates
- 2 Flutes effectively manage the large size and volume of chips produced during the aggressive machining process
- Excellent balance at high speeds and aggressive plunging capability
- Necked design with blended diameter transitions provide clearance to reach
- Ball nose design ideal for finishing operations in complex workpieces
- Recommended for materials ≤ 150 Bhn (≤ 7 HRC)

CUTTING DIAMETER D_1	LENGTH OF CUT L_2	OVERALL LENGTH L_1	SHANK DIAMETER D_2	REACH L_3	EDP NO.	
					UNCOATED	Ti-NAMITE-B (TiB ₂)
1/4	3/8	4	1/4	2-1/8	34650	34686
3/8	1/2	4	3/8	2-1/8	34651	34687
1/2	5/8	6	1/2	2-1/8	34652	34688
1/2	5/8	6	1/2	3-3/8	34653	34689
5/8	3/4	6	5/8	2-3/8	34655	34691
5/8	3/4	6	5/8	3-3/8	34654	34690
3/4	1	6	3/4	2-1/2	34656	34693
3/4	1	6	3/4	3-3/8	34657	34692

TOLERANCES (inch)

- 1/4–3/8 DIAMETER**
 $D_1 = +0.0000/-0.00035$
 $D_2 = h_6$
BALL RADIUS
 $+0.0005/-0.0005$
- 1/2–5/8 DIAMETER**
 $D_1 = +0.0000/-0.00043$
 $D_2 = h_6$
BALL RADIUS
 $+0.0005/-0.0005$
- 3/4–1 DIAMETER**
 $D_1 = +0.0000/-0.00051$
 $D_2 = h_6$
BALL RADIUS
 $+0.0005/-0.0005$

- NON-FERROUS
- PLASTICS/COMPOSITES

For patent information visit www.ksptpatents.com

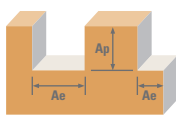

Series 47, 47B, 47L, 47LB Fractional	Hardness	Ae x D ₁	Ap x D ₁	Vc (sfm)	Diameter (D ₁) (inch)							
					1/8	1/4	3/8	1/2	5/8	3/4	1	
ALUMINUM ALLOYS 2024, 5052, 5086, 6061, 6073, 7075	Slot 	1	≤ 1	1600	RPM	48896	24448	16299	12224	9779	8149	6112
				(1280-1920)	Fz	0.0009	0.0025	0.0045	0.0060	0.0065	0.0070	0.0085
					Feed (ipm)	88	122	147	147	127	114	104
	Profile 	≤ 0.5	≤ 1.5	2000	RPM	61120	30560	20373	15280	12224	10187	7640
				(1600-2400)	Fz	0.0009	0.0025	0.0045	0.0060	0.0065	0.0070	0.0085
					Feed (ipm)	110	153	183	183	159	143	130
	HSM 	≤ 0.05	≤ 2	3300	RPM	100848	50424	33616	25212	20170	16808	12606
				(2640-3960)	Fz	0.0021	0.0055	0.0105	0.0140	0.0150	0.0165	0.0195
					Feed (ipm)	424	555	706	706	605	555	492
ALUMINUM DIE CAST ALLOYS (HIGH SILICONE) A-390, A-392, B-390	Slot 	1	≤ 1	600	RPM	18336	9168	6112	4584	3667	3056	2292
				(480-720)	Fz	0.0009	0.0025	0.0045	0.0060	0.0065	0.0070	0.0085
					Feed (ipm)	33	46	55	55	48	43	39
	Profile 	≤ 0.5	≤ 1.5	750	RPM	22920	11460	7640	5730	4584	3820	2865
				(600-900)	Fz	0.0009	0.0025	0.0045	0.0060	0.0065	0.0070	0.0085
					Feed (ipm)	41	57	69	69	60	53	49
	HSM 	≤ 0.05	≤ 2	1240	RPM	37894	18947	12631	9474	7579	6316	4737
				(992-1488)	Fz	0.0021	0.0055	0.0105	0.0140	0.0150	0.0165	0.0195
					Feed (ipm)	159	208	265	265	227	208	185
COPPER ALLOYS Aluminum Bronze Brass Naval Brass Red Brass	Slot 	1	≤ 1	865	RPM	26434	13217	8811	6609	5287	4406	3304
				(692-1038)	Fz	0.0008	0.0020	0.0040	0.0050	0.0055	0.0060	0.0070
					Feed (ipm)	42	53	70	66	58	53	46
	Profile 	≤ 0.5	≤ 1.5	1080	RPM	33005	16502	11002	8251	6601	5501	4126
				(864-1296)	Fz	0.0008	0.0020	0.0040	0.0050	0.0055	0.0060	0.0070
					Feed (ipm)	53	66	88	83	73	66	58
	HSM 	≤ 0.05	≤ 2	1780	RPM	54397	27198	18132	13599	10879	9066	6800
				(1424-2136)	Fz	0.0017	0.0045	0.0085	0.0115	0.0125	0.0140	0.0160
					Feed (ipm)	185	245	308	313	272	254	218
COPPER ALLOYS Beryllium Copper C110, Manganese Bronze, Tin Bronze	Slot 	1	≤ 1	345	RPM	10543	5272	3514	2636	2109	1757	1318
				(276-414)	Fz	0.0008	0.0020	0.0040	0.0050	0.0055	0.0060	0.0070
					Feed (ipm)	17	21	28	26	23	21	18
	Profile 	≤ 0.5	≤ 1.5	430	RPM	13141	6570	4380	3285	2628	2190	1643
				(344-516)	Fz	0.0008	0.0020	0.0040	0.0050	0.0055	0.0060	0.0070
					Feed (ipm)	21	26	35	33	29	26	23
	HSM 	≤ 0.05	≤ 2	710	RPM	21698	10849	7233	5424	4340	3616	2712
				(568-852)	Fz	0.0017	0.0045	0.0085	0.0115	0.0125	0.0140	0.0160
					Feed (ipm)	74	98	123	125	108	101	87
PLASTICS ABS, Polycarbonate, PVC, Polypropylene	Slot 	1	≤ 1	1600	RPM	48896	24448	16299	12224	9779	8149	6112
				(1280-1920)	Fz	0.0015	0.0040	0.0075	0.0100	0.0110	0.0120	0.0140
					Feed (ipm)	147	196	244	244	215	196	171
	Profile 	≤ 0.5	≤ 1.5	2000	RPM	61120	30560	20373	15280	12224	10187	7640
				(1600-2400)	Fz	0.0015	0.0040	0.0075	0.0100	0.0110	0.0120	0.0140
					Feed (ipm)	183	244	306	306	269	244	214
	HSM 	≤ 0.05	≤ 2	3300	RPM	100848	50424	33616	25212	20170	16808	12606
				(2640-3960)	Fz	0.0034	0.0090	0.0170	0.0230	0.0250	0.0275	0.0320
					Feed (ipm)	686	908	1143	1160	1008	924	807

Bhn (Brinell) HRc (Rockwell C) HRb (Rockwell B) HSM (High Speed Machining)
 $rpm = Vc \times 3.82 / D_1$
 $ipm = Fz \times 2 \times rpm$
 reduce speed and feed for materials harder than listed
 reduce cut depth and feed by 50% for long flute and long reach tools
 reduce feed and Ae when finish milling (.02 x D₁ maximum)
 refer to the KYOCERA SGS Tool Wizard® for complete technical information (www.kyocera-sgstool.com)

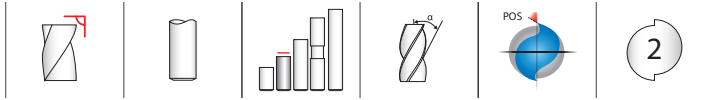

47M
METRIC SERIES

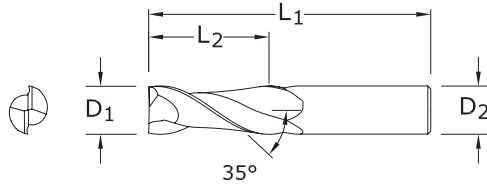

- Circular land reduces edge aggressiveness for varied speed and feed rates
- 2 Flutes effectively manage the large size and volume of chips produced during the aggressive machining process
- Excellent balance at high speeds and aggressive plunging capability
- Recommended for materials ≤ 150 Bhn (≤ 7 HRC)

CUTTING DIAMETER D_1	LENGTH OF CUT L_2	OVERALL LENGTH L_1	SHANK DIAMETER D_2	EDP NO.	
				UNCOATED	Ti-NAMITE-B (TiB ₂)
3,0	8,0	38,0	3,0	44550	44587
4,0	11,0	50,0	4,0	44551	44588
5,0	13,0	50,0	5,0	44552	44589
6,0	13,0	57,0	6,0	44553	44590
8,0	19,0	63,0	8,0	44554	44591
10,0	22,0	72,0	10,0	44555	44592
12,0	26,0	83,0	12,0	44556	44593
14,0	26,0	83,0	14,0	44557	44594
16,0	32,0	92,0	16,0	44558	44595
20,0	38,0	104,0	20,0	44559	44596
25,0	44,0	104,0	25,0	44560	44597

TOLERANCES (mm)

3 DIAMETER

$D_1 = +0,000/-0,006$

$D_2 = h_6$

>3-6 DIAMETER

$D_1 = +0,000/-0,008$

$D_2 = h_6$

>6-10 DIAMETER

$D_1 = +0,000/-0,009$

$D_2 = h_6$

>10-18 DIAMETER

$D_1 = +0,000/-0,012$

$D_2 = h_6$

>18-25 DIAMETER

$D_1 = +0,000/-0,013$

$D_2 = h_6$

NON-FERROUS

PLASTICS/COMPOSITES

For patent information visit www.ksptpatents.com

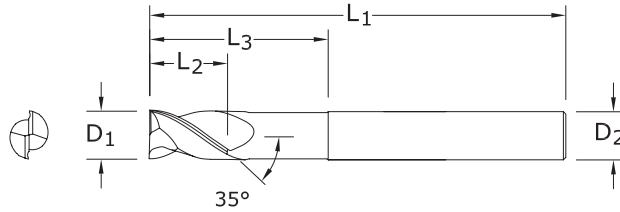
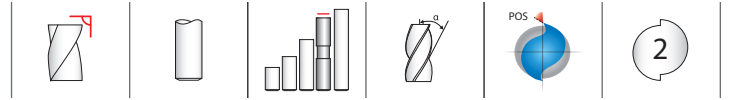

TOLERANCES (mm)

6 DIAMETER

$D_1 = +0,000/-0,008$

$D_2 = h_6$

>6-10 DIAMETER

$D_1 = +0,000/-0,009$

$D_2 = h_6$

>10-18 DIAMETER

$D_1 = +0,000/-0,011$

$D_2 = h_6$

>18-20 DIAMETER

$D_1 = +0,000/-0,013$

$D_2 = h_6$

NON-FERROUS

PLASTICS/COMPOSITES

For patent information visit www.ksptpatents.com

47ML
METRIC SERIES

CUTTING DIAMETER D_1	LENGTH OF CUT L_2	OVERALL LENGTH L_1	SHANK DIAMETER D_2	REACH L_3	EDP NO.	
					UNCOATED	Ti-NAMITE-B (TiB ₂)
6,0	10,0	100,0	6,0	54,0	44561	44609
8,0	12,0	100,0	8,0	54,0	44562	44610
10,0	12,0	100,0	10,0	54,0	44563	44611
12,0	16,0	150,0	12,0	80,0	44564	44612
16,0	20,0	150,0	16,0	80,0	44565	44613
20,0	25,0	150,0	20,0	80,0	44566	44614

- Circular land reduces edge aggressiveness for varied speed and feed rates
- 2 Flutes effectively manage the large size and volume of chips produced during the aggressive machining process
- Excellent balance at high speeds and aggressive plunging capability
- Necked design with blended diameter transitions provide clearance to reach
- Recommended for materials ≤ 150 Bhn (≤ 7 HRC)



47MB

METRIC SERIES

- Circular land reduces edge aggressiveness for varied speed and feed rates
- 2 Flutes effectively manage the large size and volume of chips produced during the aggressive machining process
- Excellent balance at high speeds and aggressive plunging capability
- Ball nose design ideal for finishing operations in complex workpieces
- Recommended for materials ≤ 150 Bhn (≤ 7 HRC)

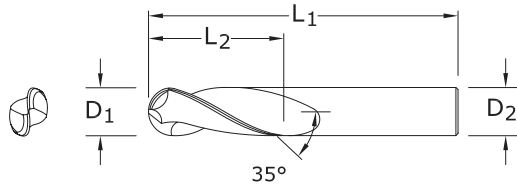

CUTTING DIAMETER D ₁	LENGTH OF CUT L ₂	OVERALL LENGTH L ₁	SHANK DIAMETER D ₂	EDP NO.	
				UNCOATED	Ti-NAMITE-B (TiB ₂)
3,0	8,0	38,0	3,0	44570	44598
4,0	11,0	50,0	4,0	44571	44599
5,0	13,0	50,0	5,0	44572	44600
6,0	13,0	57,0	6,0	44573	44601
8,0	19,0	63,0	8,0	44574	44602
10,0	22,0	72,0	10,0	44575	44603
12,0	26,0	83,0	12,0	44576	44604
14,0	26,0	83,0	14,0	44577	44605
16,0	32,0	92,0	16,0	44578	44606
20,0	37,3	104,0	20,0	44579	44607
25,0	38,0	104,0	25,0	44580	44608

TOLERANCES (mm)

- 3 DIAMETER**
D₁ = +0,000/-0,006
D₂ = h₆
BALL RADIUS
+0,0127/-0,0127
- >3-6 DIAMETER**
D₁ = +0,000/-0,008
D₂ = h₆
BALL RADIUS
+0,0127/-0,0127
- >6-10 DIAMETER**
D₁ = +0,000/-0,009
D₂ = h₆
BALL RADIUS
+0,0127/-0,0127
- >10-18 DIAMETER**
D₁ = +0,000/-0,012
D₂ = h₆
BALL RADIUS
+0,0127/-0,0127
- >18-25 DIAMETER**
D₁ = +0,000/-0,013
D₂ = h₆
BALL RADIUS
+0,0127/-0,0127

NON-FERROUS

PLASTICS/COMPOSITES

For patent information visit www.ksptpatents.com



47MLB

METRIC SERIES

- Circular land reduces edge aggressiveness for varied speed and feed rates
- 2 Flutes effectively manage the large size and volume of chips produced during the aggressive machining process
- Excellent balance at high speeds and aggressive plunging capability
- Necked design with blended diameter transitions provide clearance to reach
- Ball nose design ideal for finishing operations in complex workpieces
- Recommended for materials ≤ 150 Bhn (≤ 7 HRC)

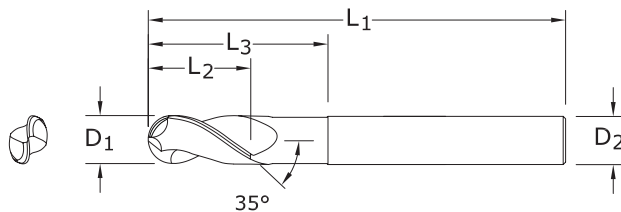

CUTTING DIAMETER D ₁	LENGTH OF CUT L ₂	OVERALL LENGTH L ₁	SHANK DIAMETER D ₂	REACH L ₃	EDP NO.	
					UNCOATED	Ti-NAMITE-B (TiB ₂)
6,0	10,0	100,0	6,0	54,0	44581	44615
8,0	12,0	100,0	8,0	54,0	44582	44616
10,0	12,0	100,0	10,0	54,0	44583	44617
12,0	16,0	150,0	12,0	80,0	44584	44618
16,0	20,0	150,0	16,0	80,0	44585	44619
20,0	25,0	150,0	20,0	80,0	44586	44620

TOLERANCES (mm)

- 6 DIAMETER**
D₁ = +0,000/-0,008
D₂ = h₆
BALL RADIUS
+0,0127/-0,0127
- >6-10 DIAMETER**
D₁ = +0,000/-0,009
D₂ = h₆
BALL RADIUS
+0,0127/-0,0127
- >10-18 DIAMETER**
D₁ = +0,000/-0,011
D₂ = h₆
BALL RADIUS
+0,0127/-0,0127
- >18-20 DIAMETER**
D₁ = +0,000/-0,013
D₂ = h₆
BALL RADIUS
+0,0127/-0,0127

NON-FERROUS

PLASTICS/COMPOSITES

For patent information visit www.ksptpatents.com

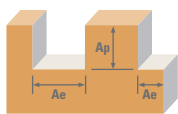

Series 47M, 47MB, 47ML, 47MLB Metric	Hardness	Ae x D ₁	Ap x D ₁	Vc (m/min)	Diameter (D ₁) (mm)								
					3	6	10	12	16	20	25		
ALUMINUM ALLOYS 2024, 5052, 5086, 6061, 6073, 7075	≤ 150 Bhn or ≤ 7 HRc	Slot 	1	≤ 1	490	RPM	52022	26011	15607	13005	9754	7803	6243
					(392-588)	Fz	0.022	0.060	0.120	0.144	0.166	0.187	0.213
					Feed (mm/min)	2247	3121	3746	3745	3246	2913	2653	
		Profile 	≤ 0.5	≤ 1.5	610	RPM	64762	32381	19429	16190	12143	9714	7771
					(488-732)	Fz	0.022	0.060	0.120	0.144	0.166	0.187	0.213
					Feed (mm/min)	2797	3885	4663	4662	4041	3627	3303	
		HSM 	≤ 0.05	≤ 2	1005	RPM	106698	53349	32009	26674	20006	16005	12804
					(804-1206)	Fz	0.050	0.132	0.280	0.336	0.384	0.440	0.488
					Feed (mm/min)	10754	14083	17925	17924	15364	14084	12484	
ALUMINUM DIE CAST ALLOYS (HIGH SILICONE) A-390, A-392, B-390	≤ 125 Bhn or ≤ 77 HRb	Slot 	1	≤ 1	185	RPM	19641	9820	5892	4910	3683	2946	2357
					(148-222)	Fz	0.022	0.060	0.120	0.144	0.166	0.187	0.213
					Feed (mm/min)	848	1178	1414	1414	1226	1100	1002	
		Profile 	≤ 0.5	≤ 1.5	230	RPM	24418	12209	7326	6105	4578	3663	2930
					(184-276)	Fz	0.022	0.060	0.120	0.144	0.166	0.187	0.213
					Feed (mm/min)	1055	1465	1758	1758	1524	1367	1245	
		HSM 	≤ 0.05	≤ 2	380	RPM	40343	20172	12103	10086	7564	6052	4841
					(304-456)	Fz	0.050	0.132	0.280	0.336	0.384	0.440	0.488
					Feed (mm/min)	4066	5325	6778	6777	5809	5325	4720	
COPPER ALLOYS Aluminum Bronze Brass Naval Brass Red Brass	≤ 140 Bhn or ≤ 3 HRc	Slot 	1	≤ 1	265	RPM	28134	14067	8440	7034	5275	4220	3376
					(212-318)	Fz	0.019	0.048	0.107	0.120	0.141	0.160	0.175
					Feed (mm/min)	1080	1350	1801	1688	1485	1350	1182	
		Profile 	≤ 0.5	≤ 1.5	330	RPM	35035	17518	10511	8759	6569	5255	4204
					(264-396)	Fz	0.019	0.048	0.107	0.120	0.141	0.160	0.175
					Feed (mm/min)	1345	1682	2242	2102	1850	1682	1472	
		HSM 	≤ 0.05	≤ 2	545	RPM	57861	28930	17358	14465	10849	8679	6943
					(436-654)	Fz	0.041	0.108	0.227	0.276	0.320	0.373	0.400
					Feed (mm/min)	4721	6248	7869	7984	6943	6480	5555	
COPPER ALLOYS Beryllium Copper C110, Manganese Bronze, Tin Bronze	≤ 200 Bhn or ≤ 23 HRc	Slot 	1	≤ 1	105	RPM	11148	5574	3344	2787	2090	1672	1338
					(84-126)	Fz	0.019	0.048	0.107	0.120	0.141	0.160	0.175
					Feed (mm/min)	428	535	713	669	589	535	468	
		Profile 	≤ 0.5	≤ 1.5	130	RPM	13802	6901	4141	3450	2588	2070	1656
					(104-156)	Fz	0.019	0.048	0.107	0.120	0.141	0.160	0.175
					Feed (mm/min)	530	662	883	828	729	662	580	
		HSM 	≤ 0.05	≤ 2	215	RPM	22826	11413	6848	5706	4280	3424	2739
					(172-258)	Fz	0.041	0.108	0.227	0.276	0.320	0.373	0.400
					Feed (mm/min)	1862	2465	3104	3150	2739	2556	2191	
PLASTICS ABS, Polycarbonate, PVC, Polypropylene		Slot 	1	≤ 1	490	RPM	52022	26011	15607	13005	9754	7803	6243
					(392-588)	Fz	0.036	0.096	0.200	0.240	0.282	0.320	0.350
					Feed (mm/min)	3745	4994	6243	6242	5493	4994	4370	
		Profile 	≤ 0.5	≤ 1.5	610	RPM	64762	32381	19429	16190	12143	9714	7771
					(488-732)	Fz	0.036	0.096	0.200	0.240	0.282	0.320	0.350
					Feed (mm/min)	4662	6217	7771	7771	6839	6217	5440	
		HSM 	≤ 0.05	≤ 2	1005	RPM	106698	53349	32009	26674	20006	16005	12804
					(804-1206)	Fz	0.082	0.216	0.453	0.552	0.640	0.733	0.800
					Feed (mm/min)	17412	23045	29022	29446	25607	23473	20487	

Bhn (Brinell) HRc (Rockwell C) HRb (Rockwell B) HSM (High Speed Machining)
 $rpm = (Vc \times 1000) / (D_1 \times 3.14)$
 $mm/min = Fz \times 2 \times rpm$
 reduce speed and feed for materials harder than listed
 reduce cut depth and feed by 50% for long flute and long reach tools
 reduce feed and Ae when finish milling (.02 x D₁ maximum)
 refer to the KYOCERA SGS Tool Wizard® for complete technical information (www.kyocera-sgstool.com)

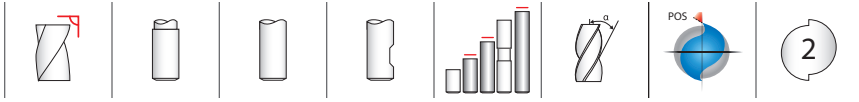

44
FRACTIONAL SERIES

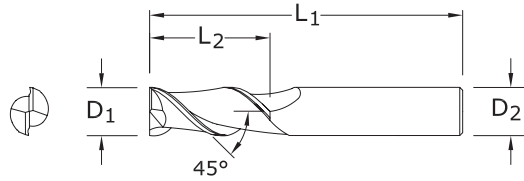

- Polished ski land with primary and secondary flute wall design minimizes chip interference by directing chips away from secondary flute
- Circular land allows for increased control at various speed and feed rates ultimately reducing chatter
- Recommended for materials ≤ 150 Bhn (≤ 7 HRC)

inch				EDP NO.			
CUTTING DIAMETER D_1	LENGTH OF CUT L_2	OVERALL LENGTH L_1	SHANK DIAMETER D_2	UNCOATED W/FLAT	Ti-NAMITE-B (TiB ₂) W/FLAT	UNCOATED	Ti-NAMITE-B (TiB ₂)
1/4	3/4	2-7/16	3/8	34501	34502	32033	32053
1/4	1-1/4	3-1/16	3/8	34503	34504	32034	32054
1/4	1-3/4	3-9/16	3/8	34505	34506	32035	32055
5/16	1-3/8	3-1/8	3/8	34507	34508	32036	32056
3/8	3/4	2-1/2	3/8	34509	34510	32037	32057
3/8	1-1/2	3-1/4	3/8	34511	34512	32038	32058
3/8	2-1/2	4-1/4	3/8	34513	34514	32039	32059
1/2	1-1/4	3-1/4	1/2	34515	34516	32040	32060
1/2	2	4	1/2	34517	34518	32041	32061
1/2	3	5	1/2	34519	34520	32042	32062
5/8	1-5/8	3-3/4	5/8	34521	34522	32043	32063
5/8	2-1/2	4-5/8	5/8	34523	34524	32044	32064
3/4	1-5/8	3-7/8	3/4	34525	34526	32045	32065
3/4	3	5-1/4	3/4	34527	34528	32046	32066
3/4	4	6-1/4	3/4	34529	34530	32047	32067
1	2	4-1/2	1	34531	34532	32048	32068
1	4	6-1/2	1	34533	34534	32049	32069

Contact your KSPT Sales Representative for more information on Corner Radius options.

TOLERANCES (inch)

1/4–3/8 DIAMETER

$D_1 = +0.0000/-0.00035$

$D_2 = h_6$

1/2–5/8 DIAMETER

$D_1 = +0.0000/-0.00043$

$D_2 = h_6$

3/4–1 DIAMETER

$D_1 = +0.0000/-0.00051$

$D_2 = h_6$

NON-FERROUS

PLASTICS/COMPOSITES

For patent information visit www.ksptpatents.com

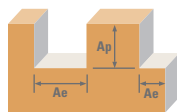

Series 44 Fractional	Hardness	Ae x D ₁	Ap x D ₁	Vc (sfm)	Diameter (D ₁) (inch)								
					1/8	1/4	3/8	1/2	5/8	3/4	1		
ALUMINUM ALLOYS 2024, 5052, 5086, 6061, 6073, 7075	≤ 150 Bhn or ≤ 7 HRc	Slot 	1	≤ 1	1600	RPM	48896	24448	16299	12224	9779	8149	6112
					(1280-1920)	Fz	0.0009	0.0025	0.0045	0.0060	0.0065	0.0070	0.0085
						Feed (ipm)	88	122	147	147	127	114	104
	Profile 	≤ 0.5	≤ 1.5	2000	RPM	61120	30560	20373	15280	12224	10187	7640	
				(1600-2400)	Fz	0.0009	0.0025	0.0045	0.0060	0.0065	0.0070	0.0085	
					Feed (ipm)	110	153	183	183	159	143	130	
	HSM 	≤ 0.05	≤ 2	3300	RPM	100848	50424	33616	25212	20170	16808	12606	
				(2640-3960)	Fz	0.0021	0.0055	0.0105	0.0140	0.0150	0.0165	0.0195	
					Feed (ipm)	424	555	706	706	605	555	492	
ALUMINUM DIE CAST ALLOYS (HIGH SILICONE) A-390, A-392, B-390	≤ 125 Bhn or ≤ 77 HRb	Slot 	1	≤ 1	600	RPM	18336	9168	6112	4584	3667	3056	2292
					(480-720)	Fz	0.0009	0.0025	0.0045	0.0060	0.0065	0.0070	0.0085
						Feed (ipm)	33	46	55	55	48	43	39
	Profile 	≤ 0.5	≤ 1.5	750	RPM	22920	11460	7640	5730	4584	3820	2865	
				(600-900)	Fz	0.0009	0.0025	0.0045	0.0060	0.0065	0.0070	0.0085	
					Feed (ipm)	41	57	69	69	60	53	49	
	HSM 	≤ 0.05	≤ 2	1240	RPM	37894	18947	12631	9474	7579	6316	4737	
				(992-1488)	Fz	0.0021	0.0055	0.0105	0.0140	0.0150	0.0165	0.0195	
					Feed (ipm)	159	208	265	265	227	208	185	
COPPER ALLOYS Aluminum Bronze Brass Naval Brass Red Brass	≤ 140 Bhn or ≤ 3 HRc	Slot 	1	≤ 1	865	RPM	26434	13217	8811	6609	5287	4406	3304
					(692-1038)	Fz	0.0008	0.0020	0.0040	0.0050	0.0055	0.0060	0.0070
						Feed (ipm)	42	53	70	66	58	53	46
	Profile 	≤ 0.5	≤ 1.5	1080	RPM	33005	16502	11002	8251	6601	5501	4126	
				(864-1296)	Fz	0.0008	0.0020	0.0040	0.0050	0.0055	0.0060	0.0070	
					Feed (ipm)	53	66	88	83	73	66	58	
	HSM 	≤ 0.05	≤ 2	1780	RPM	54397	27198	18132	13599	10879	9066	6800	
				(1424-2136)	Fz	0.0017	0.0045	0.0085	0.0115	0.0125	0.0140	0.0160	
					Feed (ipm)	185	245	308	313	272	254	218	
COPPER ALLOYS Beryllium Copper C110, Manganese Bronze, Tin Bronze	≤ 200 Bhn or ≤ 23 HRc	Slot 	1	≤ 1	345	RPM	10543	5272	3514	2636	2109	1757	1318
					(276-414)	Fz	0.0008	0.0020	0.0040	0.0050	0.0055	0.0060	0.0070
						Feed (ipm)	17	21	28	26	23	21	18
	Profile 	≤ 0.5	≤ 1.5	430	RPM	13141	6570	4380	3285	2628	2190	1643	
				(344-516)	Fz	0.0008	0.0020	0.0040	0.0050	0.0055	0.0060	0.0070	
					Feed (ipm)	21	26	35	33	29	26	23	
	HSM 	≤ 0.05	≤ 2	710	RPM	21698	10849	7233	5424	4340	3616	2712	
				(568-852)	Fz	0.0017	0.0045	0.0085	0.0115	0.0125	0.0140	0.0160	
					Feed (ipm)	74	98	123	125	108	101	87	
PLASTICS ABS, Polycarbonate, PVC, Polypropylene	≤ 150 Bhn or ≤ 7 HRc	Slot 	1	≤ 1	1600	RPM	48896	24448	16299	12224	9779	8149	6112
					(1280-1920)	Fz	0.0015	0.0040	0.0075	0.0100	0.0110	0.0120	0.0140
						Feed (ipm)	147	196	244	244	215	196	171
	Profile 	≤ 0.5	≤ 1.5	2000	RPM	61120	30560	20373	15280	12224	10187	7640	
				(1600-2400)	Fz	0.0015	0.0040	0.0075	0.0100	0.0110	0.0120	0.0140	
					Feed (ipm)	183	244	306	306	269	244	214	
	HSM 	≤ 0.05	≤ 2	3300	RPM	100848	50424	33616	25212	20170	16808	12606	
				(2640-3960)	Fz	0.0034	0.0090	0.0170	0.0230	0.0250	0.0275	0.0320	
					Feed (ipm)	686	908	1143	1160	1008	924	807	

Bhn (Brinell) HRc (Rockwell C) HRb (Rockwell B) HSM (High Speed Machining)
 $rpm = Vc \times 3.82 / D_1$
 $ipm = Fz \times 2 \times rpm$
 reduce speed and feed for materials harder than listed
 reduce cut depth and feed by 50% for long flute and long reach tools
 reduce feed and Ae when finish milling (.02 x D₁ maximum)
 refer to the KYOCERA SGS Tool Wizard® for complete technical information (www.kyocera-sgstool.com)

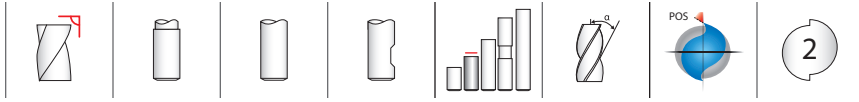

44M
METRIC SERIES

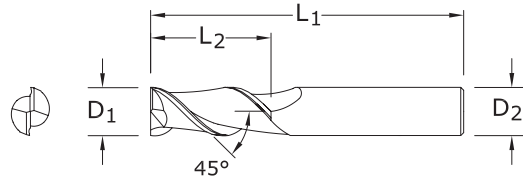

- Polished ski land with primary and secondary flute wall design minimizes chip interference by directing chips away from secondary flute
- Circular land allows for increased control at various speed and feed rates ultimately reducing chatter
- Recommended for materials ≤ 150 Bhn (≤ 7 HRC)

CUTTING DIAMETER D_1	mm			EDP NO.			
	LENGTH OF CUT L_2	OVERALL LENGTH L_1	SHANK DIAMETER D_2	UNCOATED W/FLAT	UNCOATED	Ti-NAMITE-B (TiB ₂) W/FLAT	Ti-NAMITE-B (TiB ₂)
3,0	8,0	52,0	6,0	44505	49663	44506	49674
4,0	11,0	55,0	6,0	44509	49664	44510	49675
5,0	13,0	57,0	6,0	44513	49665	44514	49676
6,0	13,0	57,0	6,0	44517	49666	44518	49677
8,0	19,0	69,0	10,0	44521	49667	44522	49678
10,0	22,0	72,0	10,0	44525	49668	44526	49679
12,0	26,0	83,0	12,0	44529	49669	44530	49680
14,0	26,0	83,0	14,0	44533	49670	44534	49681
16,0	32,0	92,0	16,0	44537	49671	44538	49682
18,0	32,0	92,0	18,0	44541	49672	44542	49683
20,0	38,0	104,0	20,0	44545	49673	44546	49684

Contact your KSPT Sales Representative for more information on Corner Radius options.

TOLERANCES (mm)

≤3 DIAMETER

$D_1 = +0,000/-0,006$

$D_2 = h_6$

>3-6 DIAMETER

$D_1 = +0,000/-0,008$

$D_2 = h_6$

>6-10 DIAMETER

$D_1 = +0,000/-0,009$

$D_2 = h_6$

>10-18 DIAMETER

$D_1 = +0,000/-0,011$

$D_2 = h_6$

>18-20 DIAMETER

$D_1 = +0,000/-0,013$









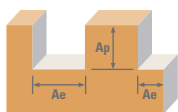





$D_2 = h_6$

NON-FERROUS

PLASTICS/COMPOSITES

For patent information visit www.ksptpatents.com



Series 44M Metric	Hardness	Ae x D ₁	Ap x D ₁	Vc (m/min)	Diameter (D ₁) (mm)								
					3	6	10	12	16	20	25		
ALUMINUM ALLOYS 2024, 5052, 5086, 6061, 6073, 7075	≤ 150 Bhn or ≤ 7HRc	Slot 	1	≤ 1	490	RPM	52022	26011	15607	13005	9754	7803	6243
					(392-588)	Fz	0.022	0.060	0.120	0.144	0.166	0.187	0.213
					Feed (mm/min)	2247	3121	3746	3745	3246	2913	2653	
		Profile 	≤ 0.5	≤ 1.5	610	RPM	64762	32381	19429	16190	12143	9714	7771
					(488-732)	Fz	0.022	0.060	0.120	0.144	0.166	0.187	0.213
					Feed (mm/min)	2797	3885	4663	4662	4041	3627	3303	
		HSM 	≤ 0.05	≤ 2	1005	RPM	106698	53349	32009	26674	20006	16005	12804
					(804-1206)	Fz	0.050	0.132	0.280	0.336	0.384	0.440	0.488
					Feed (mm/min)	10754	14083	17925	17924	15364	14084	12484	
ALUMINUM DIE CAST ALLOYS (HIGH SILICONE) A-390, A-392, B-390	≤ 125 Bhn or ≤ 77 HRb	Slot 	1	≤ 1	185	RPM	19641	9820	5892	4910	3683	2946	2357
					(148-222)	Fz	0.022	0.060	0.120	0.144	0.166	0.187	0.213
					Feed (mm/min)	848	1178	1414	1414	1226	1100	1002	
		Profile 	≤ 0.5	≤ 1.5	230	RPM	24418	12209	7326	6105	4578	3663	2930
					(184-276)	Fz	0.022	0.060	0.120	0.144	0.166	0.187	0.213
					Feed (mm/min)	1055	1465	1758	1758	1524	1367	1245	
		HSM 	≤ 0.05	≤ 2	380	RPM	40343	20172	12103	10086	7564	6052	4841
					(304-456)	Fz	0.050	0.132	0.280	0.336	0.384	0.440	0.488
					Feed (mm/min)	4066	5325	6778	6777	5809	5325	4720	
COPPER ALLOYS Aluminum Bronze Brass Naval Brass Red Brass	≤ 140 Bhn or ≤ 3 HRc	Slot 	1	≤ 1	265	RPM	28134	14067	8440	7034	5275	4220	3376
					(212-318)	Fz	0.019	0.048	0.107	0.120	0.141	0.160	0.175
					Feed (mm/min)	1080	1350	1801	1688	1485	1350	1182	
		Profile 	≤ 0.5	≤ 1.5	330	RPM	35035	17518	10511	8759	6569	5255	4204
					(264-396)	Fz	0.019	0.048	0.107	0.120	0.141	0.160	0.175
					Feed (mm/min)	1345	1682	2242	2102	1850	1682	1472	
		HSM 	≤ 0.05	≤ 2	545	RPM	57861	28930	17358	14465	10849	8679	6943
					(436-654)	Fz	0.041	0.108	0.227	0.276	0.320	0.373	0.400
					Feed (mm/min)	4721	6248	7869	7984	6943	6480	5555	
COPPER ALLOYS Beryllium Copper C110, Manganese Bronze, Tin Bronze	≤ 200 Bhn or ≤ 23 HRc	Slot 	1	≤ 1	105	RPM	11148	5574	3344	2787	2090	1672	1338
					(84-126)	Fz	0.019	0.048	0.107	0.120	0.141	0.160	0.175
					Feed (mm/min)	428	535	713	669	589	535	468	
		Profile 	≤ 0.5	≤ 1.5	130	RPM	13802	6901	4141	3450	2588	2070	1656
					(104-156)	Fz	0.019	0.048	0.107	0.120	0.141	0.160	0.175
					Feed (mm/min)	530	662	883	828	729	662	580	
		HSM 	≤ 0.05	≤ 2	215	RPM	22826	11413	6848	5706	4280	3424	2739
					(172-258)	Fz	0.041	0.108	0.227	0.276	0.320	0.373	0.400
					Feed (mm/min)	1862	2465	3104	3150	2739	2556	2191	
PLASTICS ABS, Polycarbonate, PVC, Polypropylene		Slot 	1	≤ 1	490	RPM	52022	26011	15607	13005	9754	7803	6243
					(392-588)	Fz	0.036	0.096	0.200	0.240	0.282	0.320	0.350
					Feed (mm/min)	3745	4994	6243	6242	5493	4994	4370	
		Profile 	≤ 0.5	≤ 1.5	610	RPM	64762	32381	19429	16190	12143	9714	7771
					(488-732)	Fz	0.036	0.096	0.200	0.240	0.282	0.320	0.350
					Feed (mm/min)	4662	6217	7771	7771	6839	6217	5440	
		HSM 	≤ 0.05	≤ 2	1005	RPM	106698	53349	32009	26674	20006	16005	12804
					(804-1206)	Fz	0.082	0.216	0.453	0.552	0.640	0.733	0.800
					Feed (mm/min)	17412	23045	29022	29446	25607	23473	20487	

Bhn (Brinell) HRc (Rockwell C) HRb (Rockwell B) HSM (High Speed Machining)
 $rpm = (Vc \times 1000) / (D_1 \times 3.14)$
 $mm/min = Fz \times 2 \times rpm$
 reduce speed and feed for materials harder than listed
 reduce cut depth and feed by 50% for long flute and long reach tools
 reduce feed and Ae when finish milling (.02 x D₁ maximum)
 refer to the KYOCERA SGS Tool Wizard® for complete technical information (www.kyocera-sgstool.com)

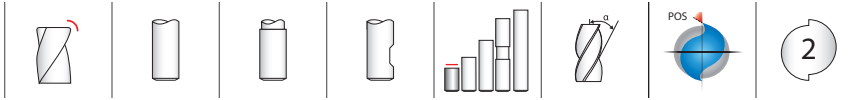

45
FRACTIONAL SERIES

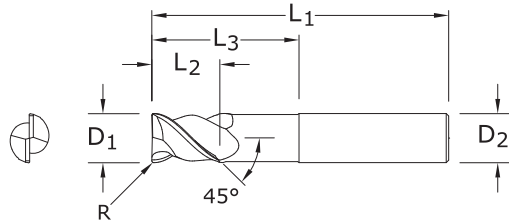

- Polished ski land with primary and secondary flute wall design minimizes chip interference by directing chips away from secondary flute
- Circular land allows for increased control at various speed and feed rates ultimately reducing chatter
- Recommended for materials ≤ 150 Bhn (≤ 7 HRC)

inch						EDP NO.			
CUTTING DIAMETER D_1	LENGTH OF CUT L_2	OVERALL LENGTH L_1	SHANK DIAMETER D_2	REACH* L_3	CORNER RADIUS R	UNCOATED W/FLAT	UNCOATED	Ti-NAMITE-B (TiB ₂) W/FLAT	Ti-NAMITE-B (TiB ₂)
1/4	3/8	2-1/2	3/8	1	.010	91257	91250	91242	91235
5/16	7/16	2-1/2	3/8	1-1/8	.012	91258	91251	91243	91236
3/8	9/16	2-1/2	3/8	1-1/8	.015	91259	91252	91244	91237
1/2	3/4	3	1/2	1-1/2	.020	91260	91253	91245	91238
5/8	7/8	3-1/2	5/8	1-3/4	.025	91261	91254	91246	91239
3/4	1	4	3/4	2	.030	91262	91255	91247	91240
1	1-1/4	4	1	2-1/8	.040	91263	91256	91248	91241

*Reach (Optional)

TOLERANCES (inch)

1/4–3/8 DIAMETER

$D_1 = +0.0000/-0.00035$

$D_2 = h_6$

$R = +0.0000/-0.0020$

1/2–5/8 DIAMETER

$D_1 = +0.0000/-0.00043$

$D_2 = h_6$

$R = +0.0000/-0.0020$

3/4–1 DIAMETER

$D_1 = +0.0000/-0.00051$

$D_2 = h_6$

$R = +0.0000/-0.0020$

NON-FERROUS

PLASTICS/COMPOSITES

For patent information visit www.ksptpatents.com

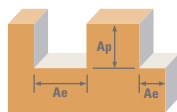

Series 45 Fractional	Hardness	Ae x D ₁	Ap x D ₁	Vc (sfm)	Diameter (D ₁) (inch)							
					1/4	3/8	1/2	5/8	3/4	1		
ALUMINUM ALLOYS 2024, 5052, 5086, 6061, 6073, 7075	≤ 150 Bhn or ≤ 7 HRc	Slot 	1	≤ 1	1600	RPM	24448	16299	12224	9779	8149	6112
					(1280-1920)	Fz	0.0025	0.0045	0.0060	0.0065	0.0070	0.0085
						Feed (ipm)	122	147	147	127	114	104
	Profile 	≤ 0.5	≤ 1.5	2000	RPM	30560	20373	15280	12224	10187	7640	
				(1600-2400)	Fz	0.0025	0.0045	0.0060	0.0065	0.0070	0.0085	
					Feed (ipm)	153	183	183	159	143	130	
	HSM 	≤ 0.05	≤ 2	3300	RPM	50424	33616	25212	20170	16808	12606	
				(2640-3960)	Fz	0.0055	0.0105	0.0140	0.0150	0.0165	0.0195	
					Feed (ipm)	555	706	706	605	555	492	
ALUMINUM DIE CAST ALLOYS (HIGH SILICONE) A-390, A-392, B-390	≤ 125 Bhn or ≤ 77 HRb	Slot 	1	≤ 1	600	RPM	9168	6112	4584	3667	3056	2292
					(480-720)	Fz	0.0025	0.0045	0.0060	0.0065	0.0070	0.0085
						Feed (ipm)	46	55	55	48	43	39
	Profile 	≤ 0.5	≤ 1.5	750	RPM	11460	7640	5730	4584	3820	2865	
				(600-900)	Fz	0.0025	0.0045	0.0060	0.0065	0.0070	0.0085	
					Feed (ipm)	57	69	69	60	53	49	
	HSM 	≤ 0.05	≤ 2	1240	RPM	18947	12631	9474	7579	6316	4737	
				(992-1488)	Fz	0.0055	0.0105	0.0140	0.0150	0.0165	0.0195	
					Feed (ipm)	208	265	265	227	208	185	
COPPER ALLOYS Aluminum Bronze Brass Naval Brass Red Brass	≤ 140 Bhn or ≤ 3 HRc	Slot 	1	≤ 1	865	RPM	13217	8811	6609	5287	4406	3304
					(692-1038)	Fz	0.0020	0.0040	0.0050	0.0055	0.0060	0.0070
						Feed (ipm)	53	70	66	58	53	46
	Profile 	≤ 0.5	≤ 1.5	1080	RPM	16502	11002	8251	6601	5501	4126	
				(864-1296)	Fz	0.0020	0.0040	0.0050	0.0055	0.0060	0.0070	
					Feed (ipm)	66	88	83	73	66	58	
	HSM 	≤ 0.05	≤ 2	1780	RPM	27198	18132	13599	10879	9066	6800	
				(1424-2136)	Fz	0.0045	0.0085	0.0115	0.0125	0.0140	0.0160	
					Feed (ipm)	245	308	313	272	254	218	
COPPER ALLOYS Beryllium Copper C110, Manganese Bronze, Tin Bronze	≤ 200 Bhn or ≤ 23 HRc	Slot 	1	≤ 1	345	RPM	5272	3514	2636	2109	1757	1318
					(276-414)	Fz	0.0020	0.0040	0.0050	0.0055	0.0060	0.0070
						Feed (ipm)	21	28	26	23	21	18
	Profile 	≤ 0.5	≤ 1.5	430	RPM	6570	4380	3285	2628	2190	1643	
				(344-516)	Fz	0.0020	0.0040	0.0050	0.0055	0.0060	0.0070	
					Feed (ipm)	26	35	33	29	26	23	
	HSM 	≤ 0.05	≤ 2	710	RPM	10849	7233	5424	4340	3616	2712	
				(568-852)	Fz	0.0045	0.0085	0.0115	0.0125	0.0140	0.0160	
					Feed (ipm)	98	123	125	108	101	87	
PLASTICS ABS, Polycarbonate, PVC, Polypropylene	≤ 150 Bhn or ≤ 7 HRc	Slot 	1	≤ 1	1600	RPM	24448	16299	12224	9779	8149	6112
					(1280-1920)	Fz	0.0040	0.0075	0.0100	0.0110	0.0120	0.0140
						Feed (ipm)	196	244	244	215	196	171
	Profile 	≤ 0.5	≤ 1.5	2000	RPM	30560	20373	15280	12224	10187	7640	
				(1600-2400)	Fz	0.0040	0.0075	0.0100	0.0110	0.0120	0.0140	
					Feed (ipm)	244	306	306	269	244	214	
	HSM 	≤ 0.05	≤ 2	3300	RPM	50424	33616	25212	20170	16808	12606	
				(2640-3960)	Fz	0.0090	0.0170	0.0230	0.0250	0.0275	0.0320	
					Feed (ipm)	908	1143	1160	1008	924	807	

Bhn (Brinell) HRc (Rockwell C) HRb (Rockwell B) HSM (High Speed Machining)
 $rpm = Vc \times 3.82 / D_1$
 $ipm = Fz \times 2 \times rpm$
 reduce speed and feed for materials harder than listed
 reduce cut depth and feed by 50% for long flute and long reach tools
 reduce feed and Ae when finish milling (.02 x D₁ maximum)
 refer to the KYOCERA SGS Tool Wizard® for complete technical information (www.kyocera-sgstool.com)

General Purpose End Mills





Milling

SERIES	GENERAL PURPOSE END MILLS DESCRIPTION	PAGE
16	4 Flute Square End Stub Fractional	192
16M	4 Flute Square End Stub Metric	222
1	4 Flute Square End Standard Length Fractional	193
1L	4 Flute Square End Long Reach Fractional	193
1EL	4 Flute Square End Extended Length Fractional	193
1M	4 Flute Square End Standard Length Metric	223
1XLM	4 Flute Square End Extra Long Reach Metric	223
14	4 Flute Double End Square Stub Fractional	197
14M	4 Flute Double End Square Stub Metric	225
1B	4 Flute Ball End Standard Length Fractional	198
1LB	4 Flute Ball End Long Reach Fractional	198
1ELB	4 Flute Ball End Extended Length Fractional	198
1MB	4 Flute Ball End Standard Length Metric	226
1XLMB	4 Flute Ball End Extra Long Reach Metric	226
14B	4 Flute Double End Ball Stub Fractional	200
14MB	4 Flute Double End Ball Stub Metric	227
1CR	4 Flute Corner Radius Standard Length Fractional	195
1MCR	4 Flute Corner Radius Standard Length Metric	224
54	4 Flute High Shear Square End Standard Length Fractional	209
54M	4 Flute High Shear Square End Standard Length Metric	235
17	2 Flute Square End Stub Fractional	178
17M	2 Flute Square End Stub Metric	213
3	2 Flute Square End Standard Length Fractional	179
3L	2 Flute Square End Long Reach Fractional	179
3EL	2 Flute Square End Extended Length Fractional	179
3M	2 Flute Square End Standard Length Metric	214
3XLM	2 Flute Square End Extra Long Reach Metric	214
59	2 Flute Square End Long Reach Fractional	181
59M	2 Flute Square End Long Reach Metric	215
15	2 Flute Double End Square Stub Fractional	183
15M	2 Flute Double End Square Stub Metric	216
3B	2 Flute Ball End Standard Length Fractional	184
3LB	2 Flute Ball End Long Reach Fractional	184
3ELB	2 Flute Ball End Extended Length Fractional	184
3MB	2 Flute Ball End Standard Length Metric	217
3XLMB	2 Flute Ball End Extra Long Reach Metric	217
59B	2 Flute Ball End Long Reach Fractional	186
59MB	2 Flute Ball End Long Reach Metric	218

Speed & Feed Recommendations listed after each series

SERIES	GENERAL PURPOSE END MILLS DESCRIPTION	PAGE
15B	2 Flute Double End Ball Stub Fractional	187
15MB	2 Flute Double End Ball Stub Metric	219
3CR	2 Flute Corner Radius Standard Length Fractional	182
52	2 Flute High Shear Square End Standard Length Fractional	208
52M	2 Flute High Shear Square End Standard Length Metric	234
5	3 Flute Square End Standard Length Fractional	188
5M	3 Flute Square End Standard Length Metric	220
5XLM	3 Flute Square End Extra Long Reach Metric	220
5B	3 Flute Ball End Standard Length Fractional	189
5MB	3 Flute Ball End Standard Length Metric	221
5XLMB	3 Flute Ball End Extra Long Reach Metric	221
61	Multi-Flute Coarse Pitch Rougher Fractional	206
61M	Multi-Flute Coarse Pitch Rougher Metric	232
62	Multi-Flute Fine Pitch Rougher Fractional	204
62M	Multi-Flute Fine Pitch Rougher Metric	230
23	3 Flute Tapered Square End Standard Length Fractional	190
24	3 Flute Tapered Corner Radius Standard Length Fractional	191
End Mill Sets	2, 3, & 4 Flute Square End Series 1, 3, 5, 14, 15	211
	2, 3, & 4 Flute Ball End Series 1B, 3B, 5B, 14B, 15B	212

Speed & Feed Recommendations listed after each series

Fresado

SERIE	DESCRIPCIÓN DE FRESAS DE USO GENERAL	PÁGINA
16	4 filos, pieza de punta cuadrada, fraccional	192
16M	4 filos, pieza de punta cuadrada, métrico	222
1	4 filos, punta cuadrada, longitud estándar, fraccional	193
1L	4 filos, punta cuadrada, largo alcance, fraccional	193
1EL	4 filos, punta cuadrada, longitud extendida, fraccional	193
1M	4 filos, punta cuadrada, longitud estándar, métrico	223
1XLM	4 filos, punta cuadrada, alcance extralargo, métrico	223
14	4 filos, pieza doble de punta cuadrada, fraccional	197
14M	4 filos, pieza doble de punta cuadrada, métrico	225
1B	4 filos, punta esférica, longitud estándar, fraccional	198
1LB	4 filos, punta esférica, largo alcance, fraccional	198
1ELB	4 filos, punta esférica, longitud extendida, fraccional	198
1MB	4 filos, punta esférica, longitud estándar, métrico	226
1XLMB	4 filos, punta esférica, alcance extralargo, métrico	226
14B	4 filos, pieza doble de punta esférica, fraccional	200
14MB	4 filos, pieza doble de punta esférica, métrico	227

SERIE	DESCRIPCIÓN DE FRESAS DE USO GENERAL	PÁGINA
1CR	4 filis, radio angulado, longitud estándar, fraccional	195
1MCR	4 filis, radio angulado, longitud estándar, métrico	224
54	4 filis, alto rendimiento, punta cuadrada, longitud estándar, fraccional	209
54M	4 filis, alto rendimiento, punta cuadrada, longitud estándar, métrico	235
17	2 filis, pieza de punta cuadrada, fraccional	178
17M	2 filis, pieza de punta cuadrada, métrico	213
3	2 filis, punta cuadrada, longitud estándar, fraccional	179
3L	2 filis, punta cuadrada, largo alcance, fraccional	179
3EL	2 filis, punta cuadrada, longitud extendida, fraccional	179
3M	2 filis, punta cuadrada, longitud estándar, métrico	214
3XLM	2 filis, punta cuadrada, alcance extralargo, métrico	214
59	2 filis, punta cuadrada, largo alcance, fraccional	181
59M	2 filis, punta cuadrada, largo alcance, métrico	215
15	2 filis, pieza doble de punta cuadrada, fraccional	183
15M	2 filis, pieza doble de punta cuadrada, métrico	216
3B	2 filis, punta esférica, longitud estándar, fraccional	184
3LB	2 filis, punta esférica, largo alcance, fraccional	184
3ELB	2 filis, punta esférica, longitud extendida, fraccional	184
3MB	2 filis, punta esférica, longitud estándar, métrico	217
3XLMB	2 filis, punta esférica, alcance extralargo, métrico	217
59B	2 filis, punta esférica, largo alcance, fraccional	186
59MB	2 filis, punta esférica, largo alcance, métrico	218
15B	2 filis, pieza doble de punta esférica, fraccional	187
15MB	2 filis, pieza doble de punta esférica, métrico	219
3CR	2 filis, radio angulado, longitud estándar, fraccional	182
52	2 filis, alto rendimiento, punta cuadrada, longitud estándar, fraccional	208
52M	2 filis, alto rendimiento, punta cuadrada, longitud estándar, métrico	234
5	3 filis, punta cuadrada, longitud estándar, fraccional	188
5M	3 filis, punta cuadrada, longitud estándar, métrico	220
5XLM	3 filis, punta cuadrada, alcance extralargo, métrico	220
5B	3 filis, punta esférica, longitud estándar, fraccional	189
5MB	3 filis, punta esférica, longitud estándar, métrico	221
5XLMB	3 filis, punta esférica, alcance extralargo, métrico	221
61	Filo múltiple, paso grueso, desbastador, fraccional	206
61M	Filo múltiple, paso grueso, desbastador, métrico	232
62	Filo múltiple, paso fino, desbastador, fraccional	204
62M	Filo múltiple, paso fino, desbastador, métrico	230
23	3 filis, cónico, punta cuadrada, longitud estándar, fraccional	190
24	3 filis, cónico, radio angulado, longitud estándar, fraccional	191
Juegos de fresas	2, 3 y 4 filis, punta cuadrada, series 1, 3, 5, 14, 15	211
	2, 3 y 4 filis, punta esférica, series 1B, 3B, 5B, 14B, 15B	212

Recomendaciones de velocidades y avances mostradas tras cada serie

Fraisage

SERIES	DESCRIPTION DE FRAISES À USAGE GÉNÉRAL	PAGE
16	4 dents à bout plat court (fractionnel)	192
16M	4 dents à bout plat court (métrique)	222
1	4 dents à bout plat longueur standard (fractionnel)	193
1L	4 dents à bout plat longue portée (fractionnel)	193
1EL	4 dents à bout plat extra-long (fractionnel)	193
1M	4 dents à bout plat longueur standard (métrique)	223
1XLM	4 dents à bout plat portée extra-longue (métrique)	223
14	4 dents à double bouts plats court (fractionnel)	197
14M	4 dents à double bouts plats court (métrique)	225
1B	4 dents à bout hémisphérique longueur standard (fractionnel)	198
1LB	4 dents à bout hémisphérique longue portée (fractionnel)	198
1ELB	4 dents à bout hémisphérique extra-long (fractionnel)	198
1MB	4 dents à bout hémisphérique longueur standard (métrique)	226
1XLMB	4 dents à bout hémisphérique portée extra-longue (métrique)	226
14B	4 dents à double bouts hémisphériques court (fractionnel)	200
14MB	4 dents à double bouts hémisphériques court (métrique)	227
1CR	4 dents rayon en coin longueur standard (fractionnel)	195
1MCR	4 dents rayon en coin longueur standard (métrique)	224
54	4 dents cisaillement élevé à bout plat longueur standard (fractionnel)	209
54M	4 dents cisaillement élevé à bout plat longueur standard (métrique)	235
17	2 dents à bout plat court (fractionnel)	178
17M	2 dents à bout plat court (métrique)	213
3	2 dents à bout plat longueur standard (fractionnel)	179
3L	2 dents à bout plat longue portée (fractionnel)	179
3EL	2 dents à bout plat extra-long (fractionnel)	179
3M	2 dents à bout plat longueur standard (métrique)	214
3XLM	2 dents à bout plat portée extra-longue (métrique)	214
59	2 dents à bout plat longue portée (fractionnel)	181
59M	2 dents à bout plat longue portée (métrique)	215
15	2 dents à double bouts plats court (fractionnel)	183
15M	2 dents à double bouts plats court (métrique)	216
3B	2 dents à bout hémisphérique longueur standard (fractionnel)	184
3LB	2 dents à bout hémisphérique longue portée (fractionnel)	184
3ELB	2 dents à bout hémisphérique extra-long (fractionnel)	184
3MB	2 dents à bout hémisphérique longueur standard (métrique)	217
3XLMB	2 dents à bout hémisphérique portée extra-longue (métrique)	217
59B	2 dents à bout hémisphérique longue portée (fractionnel)	186
59MB	2 dents à bout hémisphérique longue portée (métrique)	218
15B	2 dents à double bouts hémisphériques court (fractionnel)	187
15MB	2 dents à double bouts hémisphériques court (métrique)	219

SERIES	DESCRIPTION DE FRAISES À USAGE GÉNÉRAL	PAGE
3CR	2 dents rayon en coin longueur standard (fractionnel)	182
52	2 dents cisaillement élevé à bout plat longueur standard (fractionnel)	208
52M	2 dents cisaillement élevé à bout plat longueur standard (métrique)	234
5	3 dents à bout plat longueur standard (fractionnel)	188
5M	3 dents à bout plat longueur standard (métrique)	220
5XLM	3 dents à bout plat portée extra-longue (métrique)	220
5B	3 dents à bout hémisphérique longueur standard (fractionnel)	189
5MB	3 dents à bout hémisphérique longueur standard (métrique)	221
5XLMB	3 dents à bout hémisphérique portée extra-longue (métrique)	221
61	Multi-dents à pas gros d'ébauche (fractionnel)	206
61M	Multi-dents à pas gros d'ébauche (métrique)	232
62	Multi-dents à pas fin d'ébauche (fractionnel)	204
62M	Multi-dents à pas fin d'ébauche (métrique)	230
23	3 dents conique à bout plat longueur standard (fractionnel)	190
24	3 dents conique rayon en coin longueur standard (fractionnel)	191
Jeux de fraises	2, 3, & 4 Série goujure à bout plat 1,3,5,14,15	211
	2, 3, & 4 Série goujure à bout hémisphérique 15B, 15MB, 15B, 15MB, 15B, 15MB	212

Recommandations de vitesse et avance indiquées après chaque série

SERIE	BESCHREIBUNG DER ALLZWECK-SCHAFTFRÄSER	SEITE
16	Zölliger Schafffräser mit 4 Schneidekanten ohne Eckenradien, kurze Ausführung	192
16M	Metrischer Schafffräser mit 4 Schneidekanten ohne Eckenradien, kurze Ausführung	222
1	Zölliger Schafffräser mit 4 Schneidekanten ohne Eckenradien, Standardlänge	193
1L	Zölliger Langloch-Schafffräser mit 4 Schneidekanten ohne Eckenradien	193
1EL	Zölliger Schafffräser mit 4 Schneidekanten ohne Eckenradien, extra lang	193
1M	Metrischer Schafffräser mit 4 Schneidekanten ohne Eckenradien, Standardlänge	223
1XLM	Metrischer Superlangloch-Schafffräser mit 4 Schneidekanten ohne Eckenradien	223
14	Zölliger Schafffräser mit 4 Schneidekanten, kurze Ausführung	197
14M	Metrischer Schafffräser mit 4 Schneidekanten, kurze Ausführung	225
1B	Zölliger Schafffräser mit 4 Schneidekanten, Standardlänge	198
1LB	Zölliger Langloch-Radiuschafffräser mit 4 Schneidekanten	198
1ELB	Zölliger Schafffräser mit 4 Schneidekanten, Extra lang	198
1MB	Metrischer Schafffräser mit 4 Schneidekanten, Standardlänge	226
1XLMB	Metrischer Superlangloch-Radiuschafffräser mit 4 Schneidekanten	226
14B	Zölliger Doppelend-Radiuschafffräser mit 4 Schneidekanten, kurze Ausführung	200
14MB	Metrischer Doppelend-Radiuschafffräser mit 4 Schneidekanten, kurze Ausführung	227
1CR	Zölliger Schafffräser mit 4 Schneidekanten mit Eckenradien, Standardlänge	195
1MCR	Metrischer Schafffräser mit 4 Schneidekanten mit Eckenradien, Standardlänge	224
54	Zölliger Schafffräser hoher Scherfestigkeit mit 4 Schneidekanten ohne Eckenradien, Standardlänge	209
54M	Metrischer Schafffräser hoher Scherfestigkeit mit 4 Schneidekanten ohne Eckenradien, Standardlänge	235
17	Zölliger Schafffräser mit 2 Schneidekanten ohne Eckenradien, kurze Ausführung	178
17M	Metrischer Schafffräser mit 2 Schneidekanten ohne Eckenradien, kurze Ausführung	213
3	Zölliger Schafffräser mit 2 Schneidekanten ohne Eckenradien, Standardlänge	179
3L	Zölliger Langloch-Schafffräser mit 2 Schneidekanten ohne Eckenradien	179
3EL	Zölliger Schafffräser mit 2 Schneidekanten ohne Eckenradien, extra lang	179
3M	Metrischer Schafffräser mit 2 Schneidekanten ohne Eckenradien, Standardlänge	214
3XLM	Metrischer Superlangloch-Schafffräser mit 2 Schneidekanten ohne Eckenradien	214
59	Zölliger Langloch-Schafffräser mit 2 Schneidekanten ohne Eckenradien	181
59M	Metrischer Langloch-Schafffräser mit 2 Schneidekanten ohne Eckenradien	215
15	Zölliger Schafffräser mit 2 Schneidekanten, kurze Ausführung	183
15M	Metrischer Schafffräser mit 2 Schneidekanten, kurze Ausführung	216
3B	Zölliger Radiuschafffräser mit 2 Schneidekanten, Standardlänge	184
3LB	Zölliger Langloch-Radiuschafffräser mit 2 Schneidekanten	184
3ELB	Zölliger Schafffräser mit 2 Schneidekanten, Extra lang	184
3MB	Metrischer Schafffräser mit 2 Schneidekanten, Standardlänge	217
3XLMB	Metrischer Superlangloch-Schafffräser mit 2 Schneidekanten	217
59B	Zölliger Langloch-Radiuschafffräser mit 2 Schneidekanten	186
59MB	Metrischer Langloch-Radiuschafffräser mit 2 Schneidekanten	218
15B	Zölliger Doppelend-Radiuschafffräser mit 2 Schneidekanten, kurze Ausführung	187
15MB	Metrischer Doppelend-Radiuschafffräser mit 2 Schneidekanten, kurze Ausführung	219

SERIE	BESCHREIBUNG DER ALLZWECK-SCHAFTFRÄSER	SEITE
3CR	Zölliger Schaftfräser mit 2 Schneidekanten mit Eckenradien, Standardlänge	182
52	Zölliger Schaftfräser hoher Scherfestigkeit mit 2 Schneidekanten ohne Eckenradien, Standardlänge	208
52M	Metrischer Schaftfräser hoher Scherfestigkeit mit 2 Schneidekanten ohne Eckenradien, Standardlänge	234
5	Zölliger Schaftfräser mit 3 Schneidekanten ohne Eckenradien, Standardlänge	188
5M	Metrischer Schaftfräser mit 3 Schneidekanten ohne Eckenradien, Standardlänge	220
5XLM	Metrischer Superlangloch-Schaftfräser mit 3 Schneidekanten ohne Eckenradien	220
5B	Zölliger Schaftfräser mit 3 Schneidekanten, Standardlänge	189
5MB	Metrischer Schaftfräser mit 3 Schneidekanten, Standardlänge	221
5XLMB	Metrischer Superlangloch-Schaftfräser mit 3 Schneidekanten	221
61	Zölliger mehrschneidiger fein verzahnter Schruffräser	206
61M	Metrischer mehrschneidiger fein verzahnter Schruffräser	232
62	Zölliger mehrschneidiger fein verzahnter Schruffräser	204
62M	Metrischer mehrschneidiger fein verzahnter Schruffräser	230
23	Zölliger Schaftfräser mit 3 Schneidekanten ohne Eckenradien, Standardlänge	190
24	Zölliger Schaftfräser mit 3 Schneidekanten mit Eckenradien, Standardlänge	191
Richtwerte zum Fräsen	Schaftfräser mit 2, 3 und 4 Schneidekanten ohne Eckenradien, Serien 1, 3, 5, 14, 15 Radiumschaftfräser mit 2, 3 und 4 Schneidekanten, Serien 1B, 3B, 5B, 14B ,15B	211 212

Empfehlungen für Drehzahl & Vorschub im Anhang zu jeder Serie

2 Flute Square End Stub

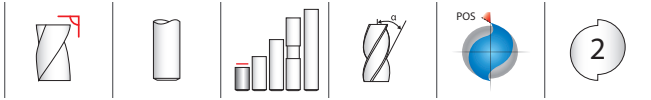

17
FRACTIONAL SERIES

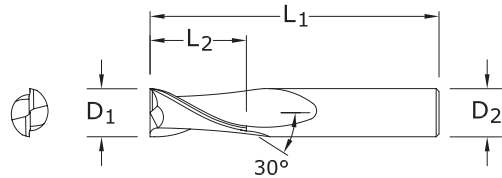

TOLERANCES (inch)

D₁ = +0.0000/-0.0020
D₂ = h₆

- STEELS
- STAINLESS STEELS
- CAST IRON
- HIGH TEMP ALLOYS
- TITANIUM
- HARDENED STEELS
- NON-FERROUS
- PLASTICS/COMPOSITES

inch				EDP NO.			
CUTTING DIAMETER D ₁	LENGTH OF CUT L ₂	OVERALL LENGTH L ₁	SHANK DIAMETER D ₂	UNCOATED	Ti-NAMITE (TiN)	Ti-NAMITE-C (TiCN)	Ti-NAMITE-A (AlTiN)
1/16	1/8	1-1/2	1/8	31701	31750	31303	31358
3/32	3/16	1-1/2	1/8	31703	31751	31304	31359
1/8	1/4	1-1/2	1/8	31705	31752	31305	31360
5/32	5/16	2	3/16	31707	31753	31306	31361
3/16	3/8	2	3/16	31709	31754	31307	31362
7/32	7/16	2	1/4	31711	31755	31308	31363
1/4	1/2	2	1/4	31713	31756	31309	31364
5/16	1/2	2	5/16	31715	31757	31310	31365
3/8	5/8	2	3/8	31717	31758	31311	31366
7/16	5/8	2-1/2	7/16	31719	31759	31312	31367
1/2	5/8	2-1/2	1/2	31721	31760	31313	31368
5/8	3/4	3	5/8	31723	31761	31314	31369
3/4	1	3	3/4	31725	31762	31315	31370

For patent information visit www.ksptpatents.com

2 Flute Square End

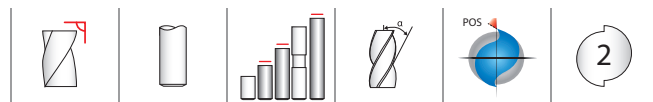

TOLERANCES (inch)

D₁ = +0.0000/-0.0020

D₂ = h₆

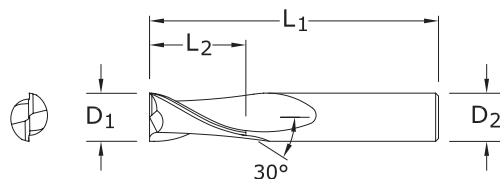

3•3L•3EL

FRACTIONAL SERIES

inch				EDP NO.					SERIES
CUTTING DIAMETER D ₁	LENGTH OF CUT L ₂	OVERALL LENGTH L ₁	SHANK DIAMETER D ₂	UNCOATED	Ti-NAMITE (TiN)	Ti-NAMITE-C (TiCN)	Ti-NAMITE-A (AlTiN)	Di-NAMITE® (Diamond)	
1/64	1/32	1-1/2	1/8	30301	39301	39501	30397	—	3
1/32	5/64	1-1/2	1/8	30303	39303	39503	30398	—	3
3/64	7/64	1-1/2	1/8	30305	39305	39505	30399	—	3
1/16	3/16	1-1/2	1/8	30307	39307	39507	30400	91266	3
5/64	3/16	1-1/2	1/8	30309	39309	39509	30435	—	3
3/32	9/32	1-1/2	1/8	30311	39311	39511	30436	—	3
7/64	3/8	1-1/2	1/8	30313	39313	39513	30437	—	3
1/8	3/8	1-1/2	1/8	30377	39377	39577	30469	—	3
*1/8	1/2	1-1/2	1/8	30315	39315	39515	30438	91270	3
1/8	3/4	2-1/4	1/8	33341	31800	31810	31850	—	3L
1/8	1	3	1/8	33343	31938	31948	31958	—	3EL
9/64	1/2	2	3/16	30317	39317	39517	30439	—	3
5/32	1/2	2	3/16	30319	39319	39519	30440	—	3
11/64	5/8	2	3/16	30321	39321	39521	30441	—	3
*3/16	5/8	2	3/16	30323	39323	39523	30442	91274	3
3/16	3/4	2-1/2	3/16	33301	31820	31825	31851	—	3L
3/16	1-1/8	3	3/16	33321	31939	31949	31959	—	3EL
13/64	5/8	2-1/2	1/4	30325	39325	39525	30443	—	3
7/32	5/8	2-1/2	1/4	30327	39327	39527	30444	—	3
15/64	3/4	2-1/2	1/4	30329	39329	39529	30445	—	3
*1/4	3/4	2-1/2	1/4	30331	39331	39531	30446	91278	3
1/4	1-1/8	3	1/4	33303	31802	31812	31852	—	3L
1/4	1-1/2	4	1/4	33323	31940	31950	31960	—	3EL
17/64	3/4	2-1/2	5/16	30333	39333	39533	30447	—	3
9/32	3/4	2-1/2	5/16	30335	39335	39535	30448	—	3
19/64	13/16	2-1/2	5/16	30337	39337	39537	30449	—	3
*5/16	13/16	2-1/2	5/16	30339	39339	39539	30450	91282	3
5/16	1-1/8	3	5/16	33305	31821	31826	31853	—	3L
5/16	1-5/8	4	5/16	33325	31941	31951	31961	—	3EL
21/64	1	2-1/2	3/8	30341	39341	39541	30451	—	3
11/32	1	2-1/2	3/8	30343	39343	39543	30452	—	3
23/64	1	2-1/2	3/8	30345	39345	39545	30453	—	3
*3/8	1	2-1/2	3/8	30347	39347	39547	30454	91286	3
3/8	1-1/8	3	3/8	33307	31804	31814	31854	—	3L

- STEELS
- STAINLESS STEELS
- CAST IRON
- HIGH TEMP ALLOYS
- TITANIUM
- HARDENED STEELS
- NON-FERROUS
- PLASTICS/COMPOSITES

For patent information visit www.ksptpatents.com

continued on next page

2 Flute Square End

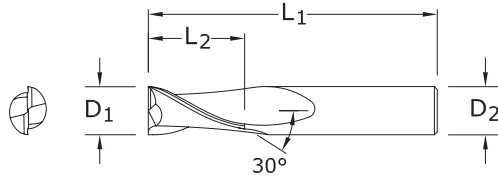
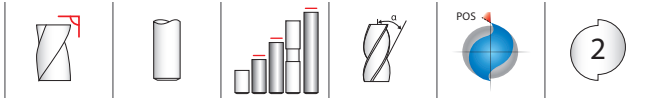

3·3L·3EL
FRACTIONAL SERIES

TOLERANCES (inch)
D₁ = +0.0000/-0.0020
D₂ = h₆

CONTINUED

- STEELS
- STAINLESS STEELS
- CAST IRON
- HIGH TEMP ALLOYS
- TITANIUM
- HARDENED STEELS
- NON-FERROUS
- PLASTICS/COMPOSITES

For patent information visit www.ksptpatents.com

CUTTING DIAMETER D ₁	inch			EDP NO.					SERIES
	LENGTH OF CUT L ₂	OVERALL LENGTH L ₁	SHANK DIAMETER D ₂	UNCOATED	Ti-NAMITE (TiN)	Ti-NAMITE-C (TiCN)	Ti-NAMITE-A (AlTiN)	Di-NAMITE® (Diamond)	
3/8	1-3/4	4	3/8	33327	31942	31952	31962	—	3EL
25/64	1	2-3/4	7/16	30349	39349	39549	30455	—	3
13/32	1	2-3/4	7/16	30351	39351	39551	30456	—	3
27/64	1	2-3/4	7/16	30353	39353	39553	30457	—	3
7/16	1	2-3/4	7/16	30355	39355	39555	30458	—	3
7/16	2	4-1/2	7/16	33309	31822	31827	31855	—	3L
7/16	3	6	7/16	33329	31943	31953	31963	—	3EL
29/64	1	3	1/2	30357	39357	39557	30459	—	3
15/32	1	3	1/2	30359	39359	39559	30460	—	3
31/64	1	3	1/2	30361	39361	39561	30461	—	3
*1/2	1	3	1/2	30363	39363	39563	30462	91290	3
1/2	2	4-1/2	1/2	33311	31806	31816	31856	—	3L
1/2	3	6	1/2	33331	31944	31954	31964	—	3EL
9/16	1-1/8	3-1/2	9/16	30365	39365	39565	30463	—	3
5/8	1-1/4	3-1/2	5/8	30367	39367	39567	30464	—	3
5/8	2-1/4	5	5/8	33313	31823	31817	31857	—	3L
5/8	3	6	5/8	33333	31945	31955	31965	—	3EL
11/16	1-3/8	4	3/4	30369	39369	39569	30465	—	3
3/4	1-1/2	4	3/4	30371	39371	39571	30466	—	3
3/4	2-1/4	5	3/4	33315	31808	31818	31858	—	3L
3/4	3	6	3/4	33335	31946	31956	31966	—	3EL
7/8	1-1/2	4	7/8	30373	39373	39573	30467	—	3
1	1-1/2	4	1	30375	39375	39575	30468	—	3
1	2-1/4	5	1	33317	31824	31819	31859	—	3L
1	3	6	1	33337	31947	31957	31967	—	3EL
*Series 3 Set				30389	39389	39589	30470	—	3

2 Flute Square End Long Reach



TOLERANCES (inch)

$D_1 = +0.0000/-0.0020$

$D_2 = h_6$

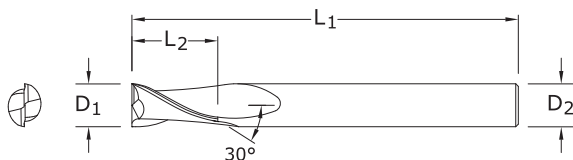

59

FRACTIONAL SERIES

inch				EDP NO.		
CUTTING DIAMETER D_1	LENGTH OF CUT L_2	OVERALL LENGTH L_1	SHANK DIAMETER D_2	Ti-NAMITE (TiN)	Ti-NAMITE-C (TiCN)	Ti-NAMITE-A (AlTiN)
1/8	3/8	2-1/2	1/4	32280	32260	32270
3/16	9/16	3	1/4	32281	32261	32271
1/4	5/8	3-1/2	1/4	32282	32262	32272
5/16	11/16	4	5/16	32283	32263	32273
3/8	7/8	4	3/8	32284	32264	32274
1/2	1	4-1/2	1/2	32285	32265	32275
5/8	1-1/8	5	5/8	32286	32266	32276
3/4	1-3/8	5-1/4	3/4	32287	32267	32277

Neck Option Available

- STEELS
- STAINLESS STEELS
- CAST IRON
- HIGH TEMP ALLOYS
- TITANIUM
- HARDENED STEELS
- NON-FERROUS
- PLASTICS/COMPOSITES

For patent information visit www.ksptpatents.com

2 Flute Corner Radius

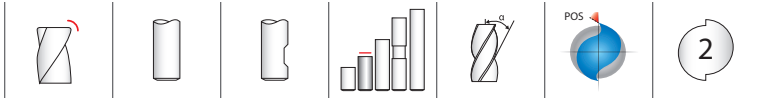

3CR
FRACTIONAL SERIES

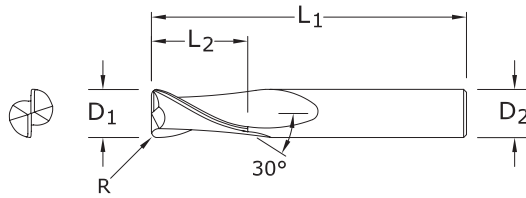

TOLERANCES (inch)

D₁ = -0.0010/-0.0020
D₂ = h₆
R = +0.0000/-0.0020

- STEELS
- STAINLESS STEELS
- CAST IRON
- HIGH TEMP ALLOYS
- TITANIUM
- HARDENED STEELS
- NON-FERROUS
- PLASTICS/COMPOSITES

For patent information visit www.ksptpatents.com

CUTTING DIAMETER D ₁	LENGTH OF CUT L ₂	inch			CORNER RADIUS R	EDP NO.			
		OVERALL LENGTH L ₁	SHANK DIAMETER D ₂			UNCOATED	Ti-NAMITE (TiN)	Ti-NAMITE-C (TiCN)	Ti-NAMITE-A (AlTiN)
1/8*	1/2	1-1/2	1/8		.015	38201	38202	38315	38357
1/8*	1/2	1-1/2	1/8		.020	38203	38204	38316	38358
3/16*	5/8	2	3/16		.015	38209	38210	38317	38359
3/16*	5/8	2	3/16		.020	38211	38212	38318	38360
3/16*	5/8	2	3/16		.030	38213	38214	38319	38361
1/4*	3/4	2-1/2	1/4		.015	38219	38220	38320	38362
1/4*	3/4	2-1/2	1/4		.020	38221	38222	38321	38363
1/4*	3/4	2-1/2	1/4		.030	38223	38224	38322	38364
1/4*	3/4	2-1/2	1/4		.045	38225	38226	38323	38365
5/16*	13/16	2-1/2	5/16		.015	38231	38232	38324	38366
5/16*	13/16	2-1/2	5/16		.020	38233	38234	38325	38367
5/16*	13/16	2-1/2	5/16		.030	38235	38236	38326	38368
5/16*	13/16	2-1/2	5/16		.045	38237	38238	38327	38369
3/8	1	2-1/2	3/8		.015	38245	38246	38328	38370
3/8	1	2-1/2	3/8		.020	38247	38248	38329	38371
3/8	1	2-1/2	3/8		.030	38249	38250	38330	38372
3/8	1	2-1/2	3/8		.045	38251	38252	38331	38373
1/2	1	3	1/2		.015	38259	38260	38332	38374
1/2	1	3	1/2		.020	38261	38262	38333	38375
1/2	1	3	1/2		.030	38263	38264	38334	38376
1/2	1	3	1/2		.045	38265	38266	38335	38377
1/2	1	3	1/2		.060	38267	38268	38336	38378
5/8	1-1/4	3-1/2	5/8		.015	38273	38274	38337	38379
5/8	1-1/4	3-1/2	5/8		.020	38275	38276	38338	38380
5/8	1-1/4	3-1/2	5/8		.030	38277	38278	38339	38381
5/8	1-1/4	3-1/2	5/8		.045	38279	38280	38340	38382
5/8	1-1/4	3-1/2	5/8		.060	38281	38282	38341	38383
5/8	1-1/4	3-1/2	5/8		.090	38283	38284	38342	38384
3/4	1-1/2	4	3/4		.015	38287	38288	38343	38385
3/4	1-1/2	4	3/4		.020	38289	38290	38344	38386
3/4	1-1/2	4	3/4		.030	38291	38292	38345	38387
3/4	1-1/2	4	3/4		.045	38293	38294	38346	38388
3/4	1-1/2	4	3/4		.060	38295	38296	38347	38389
3/4	1-1/2	4	3/4		.090	38297	38298	38348	38390
3/4	1-1/2	4	3/4		.125	38299	38300	38349	38391
1	1-1/2	4	1		.015	38301	38302	38350	38392
1	1-1/2	4	1		.020	38303	38304	38351	38393
1	1-1/2	4	1		.030	38305	38306	38352	38394
1	1-1/2	4	1		.045	38307	38308	38353	38395
1	1-1/2	4	1		.060	38309	38310	38354	38396
1	1-1/2	4	1		.090	38311	38312	38355	38397
1	1-1/2	4	1		.125	38313	38314	38356	38398

*Without Flat

2 Flute Double End Mills



TOLERANCES (inch)

D₁ = +0.0000/-0.0020

D₂ = h₆

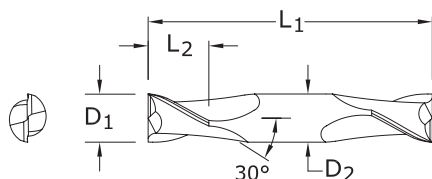

15
FRACTIONAL SERIES

inch				EDP NO.			
CUTTING DIAMETER D ₁	LENGTH OF CUT L ₂	OVERALL LENGTH L ₁	SHANK DIAMETER D ₂	UNCOATED	Ti-NAMITE (TiN)	Ti-NAMITE-C (TiCN)	Ti-NAMITE-A (AlTiN)
1/32	1/16	1-1/2	1/8	31501	31541	39651	31316
3/64	3/32	1-1/2	1/8	31503	31543	39653	31317
1/16	1/8	1-1/2	1/8	31505	31545	39655	31318
5/64	1/8	1-1/2	1/8	31507	31547	39657	31319
3/32	3/16	1-1/2	1/8	31509	31549	39659	31320
7/64	3/16	1-1/2	1/8	31511	31551	39661	31321
*1/8	1/4	1-1/2	1/8	31513	31553	39663	31322
9/64	5/16	2	3/16	31515	31555	39665	31323
5/32	5/16	2	3/16	31517	31557	39667	31324
11/64	5/16	2	3/16	31519	31559	39669	31325
*3/16	3/8	2	3/16	31521	31561	39671	31326
13/64	1/2	2-1/2	1/4	31523	31563	39673	31327
7/32	1/2	2-1/2	1/4	31525	31565	39675	31328
15/64	1/2	2-1/2	1/4	31527	31567	39677	31329
*1/4	1/2	2-1/2	1/4	31529	31569	39679	31330
9/32	1/2	2-1/2	5/16	31531	31571	39681	31331
*5/16	1/2	2-1/2	5/16	31533	31573	39683	31332
*3/8	9/16	2-1/2	3/8	31535	31575	39685	31333
7/16	9/16	2-3/4	7/16	31537	31577	39687	31334
*1/2	5/8	3	1/2	31539	31579	39689	31335
*Series 15 Set				31589	31581	39691	31336

- STEELS
- STAINLESS STEELS
- CAST IRON
- HIGH TEMP ALLOYS
- TITANIUM
- HARDENED STEELS
- NON-FERROUS
- PLASTICS/COMPOSITES

For patent information visit www.ksptpatents.com

2 Flute Ball End

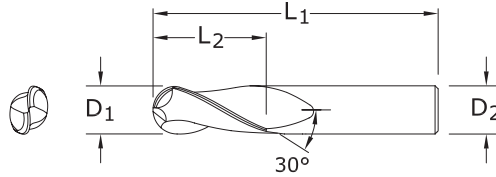
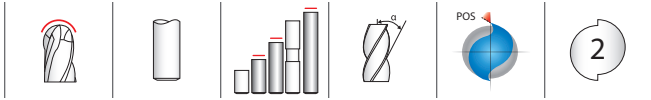

TOLERANCES (inch)

$D_1 = +0.0000/-0.0020$

$D_2 = h_6$

BALL RADIUS

$+0.0000/-0.0010$

3B•3LB•3ELB

FRACTIONAL SERIES

- STEELS
- STAINLESS STEELS
- CAST IRON
- HIGH TEMP ALLOYS
- TITANIUM
- HARDENED STEELS
- NON-FERROUS
- PLASTICS/COMPOSITES

For patent information visit www.ksptpatents.com

inch				EDP NO.				SERIES
CUTTING DIAMETER D_1	LENGTH OF CUT L_2	OVERALL LENGTH L_1	SHANK DIAMETER D_2	UNCOATED	Ti-NAMITE (TiN)	Ti-NAMITE-C (TiCN)	Ti-NAMITE-A (AlTiN)	
1/64	1/32	1-1/2	1/8	30302	39302	39502	30471	3B
1/32	5/64	1-1/2	1/8	30304	39304	39504	30472	3B
3/64	7/64	1-1/2	1/8	30306	39306	39506	30473	3B
1/16	3/16	1-1/2	1/8	30308	39308	39508	30474	3B
5/64	3/16	1-1/2	1/8	30310	39310	39510	30475	3B
3/32	9/32	1-1/2	1/8	30312	39312	39512	30476	3B
7/64	3/8	1-1/2	1/8	30314	39314	39514	30477	3B
1/8	3/8	1-1/2	1/8	30378	39378	39578	30599	3B
*1/8	1/2	1-1/2	1/8	30316	39316	39516	30478	3B
1/8	3/4	2-1/4	1/8	33342	31830	31840	31890	3LB
1/8	1	3	1/8	33344	31968	31978	31988	3ELB
9/64	1/2	2	3/16	30318	39318	39518	30479	3B
5/32	1/2	2	3/16	30320	39320	39520	30480	3B
11/64	5/8	2	3/16	30322	39322	39522	30481	3B
*3/16	5/8	2	3/16	30324	39324	39524	30482	3B
3/16	3/4	2-1/2	3/16	33302	31831	31841	31891	3LB
3/16	1-1/8	3	3/16	33322	31969	31979	31989	3ELB
13/64	5/8	2-1/2	1/4	30326	39326	39526	30483	3B
7/32	5/8	2-1/2	1/4	30328	39328	39528	30484	3B
15/64	3/4	2-1/2	1/4	30330	39330	39530	30485	3B
*1/4	3/4	2-1/2	1/4	30332	39332	39532	30486	3B
1/4	1-1/8	3	1/4	33304	31832	31842	31892	3LB
1/4	1-1/2	4	1/4	33324	31970	31980	31990	3ELB
17/64	3/4	2-1/2	5/16	30334	39334	39534	30487	3B
9/32	3/4	2-1/2	5/16	30336	39336	39536	30488	3B
19/64	13/16	2-1/2	5/16	30338	39338	39538	30489	3B
*5/16	13/16	2-1/2	5/16	30340	39340	39540	30490	3B
5/16	1-1/8	3	5/16	33306	31833	31843	31893	3LB
5/16	1-5/8	4	5/16	33326	31971	31981	31991	3ELB
21/64	1	2-1/2	3/8	30342	39342	39542	30491	3B

continued on next page

FRACTIONAL
2 Flute Ball End

3B•3LB•3ELB
 FRACTIONAL SERIES

inch				EDP NO.				SERIES
CUTTING DIAMETER D ₁	LENGTH OF CUT L ₂	OVERALL LENGTH L ₁	SHANK DIAMETER D ₂	UNCOATED	Ti-NAMITE (TiN)	Ti-NAMITE-C (TiCN)	Ti-NAMITE-A (AlTiN)	
11/32	1	2-1/2	3/8	30344	39344	39544	30492	3B
23/64	1	2-1/2	3/8	30346	39346	39546	30493	3B
*3/8	1	2-1/2	3/8	30348	39348	39548	30494	3B
3/8	1-1/8	3	3/8	33308	31834	31844	31894	3LB
3/8	1-3/4	4	3/8	33328	31972	31982	31992	3ELB
25/64	1	2-3/4	7/16	30350	39350	39550	30495	3B
13/32	1	2-3/4	7/16	30352	39352	39552	30496	3B
27/64	1	2-3/4	7/16	30354	39354	39554	30497	3B
7/16	1	2-3/4	7/16	30356	39356	39556	30498	3B
7/16	2	4-1/2	7/16	33310	31835	31845	31895	3LB
7/16	3	6	7/16	33330	31973	31983	31993	3ELB
29/64	1	3	1/2	30358	39358	39558	30499	3B
15/32	1	3	1/2	30360	39360	39560	30500	3B
31/64	1	3	1/2	30362	39362	39562	30591	3B
*1/2	1	3	1/2	30364	39364	39564	30592	3B
1/2	2	4-1/2	1/2	33312	31836	31846	31896	3LB
1/2	3	6	1/2	33332	31974	31984	31994	3ELB
9/16	1-1/8	3-1/2	9/16	30366	39366	39566	30593	3B
5/8	1-1/4	3-1/2	5/8	30368	39368	39568	30594	3B
5/8	2-1/4	5	5/8	33314	31837	31847	31897	3LB
5/8	3	6	5/8	33334	31975	31985	31995	3ELB
11/16	1-3/8	4	3/4	30370	39370	39570	30595	3B
3/4	1-1/2	4	3/4	30372	39372	39572	30596	3B
3/4	2-1/4	5	3/4	33316	31838	31848	31898	3LB
3/4	3	6	3/4	33336	31976	31986	31996	3ELB
7/8	1-1/2	4	7/8	30374	39374	39574	30597	3B
1	1-1/2	4	1	30376	39376	39576	30598	3B
1	2-1/4	5	1	33318	31839	31849	31899	3LB
1	3	6	1	33338	31977	31987	31997	3ELB
*Series 3B Set				30390	39390	39590	30600	3B

CONTINUED

2 Flute Ball End Long Reach

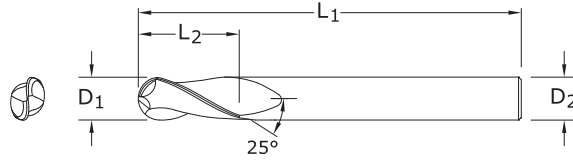
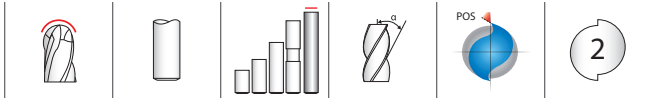

TOLERANCES (inch)

$D_1 = +0.0000/-0.0020$

$D_2 = h_6$

BALL RADIUS

$+0.0000/-0.0010$

59B

FRACTIONAL SERIES

- STEELS
- STAINLESS STEELS
- CAST IRON
- HIGH TEMP ALLOYS
- TITANIUM
- HARDENED STEELS
- NON-FERROUS
- PLASTICS/COMPOSITES

inch				EDP NO.		
CUTTING DIAMETER D_1	LENGTH OF CUT L_2	OVERALL LENGTH L_1	SHANK DIAMETER D_2	Ti-NAMITE (TiN)	Ti-NAMITE-C (TiCN)	Ti-NAMITE-A (AlTiN)
1/8	3/8	2-1/2	1/4	32210	32290	32200
3/16	9/16	3	1/4	32211	32291	32201
1/4	5/8	3-1/2	1/4	32212	32292	32202
5/16	11/16	4	5/16	32213	32293	32203
3/8	7/8	4	3/8	32214	32294	32204
1/2	1	4-1/2	1/2	32215	32295	32205
5/8	1-1/8	5	5/8	32216	32296	32206
3/4	1-3/8	5-1/4	3/4	32217	32297	32207

Neck Option Available

For patent information visit www.ksptpatents.com

FRACTIONAL 2 Flute Double End Ball End

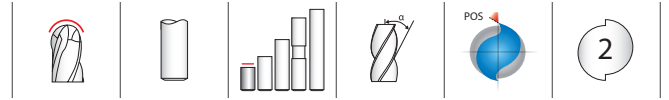

TOLERANCES (inch)
 $D_1 = +0.0000/-0.0020$
 $D_2 = h_6$
BALL RADIUS
 $+0.0000/-0.0010$

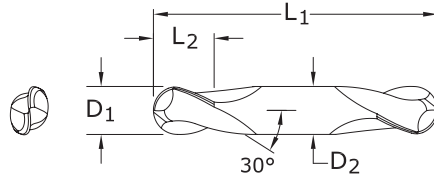

15B
FRACTIONAL SERIES

inch				EDP NO.			
CUTTING DIAMETER D_1	LENGTH OF CUT L_2	OVERALL LENGTH L_1	SHANK DIAMETER D_2	UNCOATED	Ti-NAMITE (TiN)	Ti-NAMITE-C (TiCN)	Ti-NAMITE-A (AlTiN)
1/32	1/16	1-1/2	1/8	31502	31542	39652	31337
3/64	3/32	1-1/2	1/8	31504	31544	39654	31338
1/16	1/8	1-1/2	1/8	31506	31546	39656	31339
5/64	1/8	1-1/2	1/8	31508	31548	39658	31340
3/32	3/16	1-1/2	1/8	31510	31550	39660	31341
7/64	3/16	1-1/2	1/8	31512	31552	39662	31342
*1/8	1/4	1-1/2	1/8	31514	31554	39664	31343
9/64	5/16	2	3/16	31516	31556	39666	31344
5/32	5/16	2	3/16	31518	31558	39668	31345
11/64	5/16	2	3/16	31520	31560	39670	31346
*3/16	3/8	2	3/16	31522	31562	39672	31347
13/64	1/2	2-1/2	1/4	31524	31564	39674	31348
7/32	1/2	2-1/2	1/4	31526	31566	39676	31349
15/64	1/2	2-1/2	1/4	31528	31568	39678	31350
*1/4	1/2	2-1/2	1/4	31530	31570	39680	31351
9/32	1/2	2-1/2	5/16	31532	31572	39682	31352
*5/16	1/2	2-1/2	5/16	31534	31574	39684	31353
*3/8	9/16	2-1/2	3/8	31536	31576	39686	31354
7/16	9/16	2-3/4	7/16	31538	31578	39688	31355
*1/2	5/8	3	1/2	31540	31580	39690	31356
*Series 15B Set				31590	31582	39692	31357

- STEELS
- STAINLESS STEELS
- CAST IRON
- HIGH TEMP ALLOYS
- TITANIUM
- HARDENED STEELS
- NON-FERROUS
- PLASTICS/COMPOSITES

For patent information visit www.ksptpatents.com

3 Flute Square End

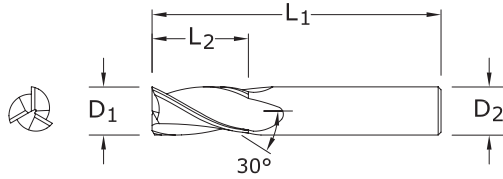
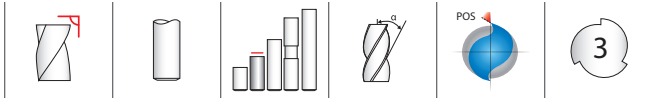

5 FRACTIONAL SERIES

TOLERANCES (inch)

D₁ = +0.0000/-0.0020
D₂ = h₆

- STEELS
- STAINLESS STEELS
- CAST IRON
- HIGH TEMP ALLOYS
- TITANIUM
- HARDENED STEELS
- NON-FERROUS
- PLASTICS/COMPOSITES

For patent information visit www.ksptpatents.com

inch				EDP NO.			
CUTTING DIAMETER D ₁	LENGTH OF CUT L ₂	OVERALL LENGTH L ₁	SHANK DIAMETER D ₂	UNCOATED	Ti-NAMITE (TiN)	Ti-NAMITE-C (TiCN)	Ti-NAMITE-A (AlTiN)
1/64	1/32	1-1/2	1/8	30501	39701	30771	30811
1/32	5/64	1-1/2	1/8	30503	39703	30772	30812
3/64	7/64	1-1/2	1/8	30505	39705	30773	30813
1/16	3/16	1-1/2	1/8	30507	39707	30774	30814
5/64	3/16	1-1/2	1/8	30509	39709	30775	30815
3/32	9/32	1-1/2	1/8	30511	39711	30776	30816
7/64	3/8	1-1/2	1/8	30513	39713	30777	30817
1/8	3/8	1-1/2	1/8	30577	39777	30809	30849
1/8	1/2	1-1/2	1/8	30515	39715	30778	30818
9/64	1/2	2	3/16	30517	39717	30779	30819
5/32	1/2	2	3/16	30519	39719	30780	30820
11/64	5/8	2	3/16	30521	39721	30781	30821
3/16	5/8	2	3/16	30523	39723	30782	30822
13/64	5/8	2-1/2	1/4	30525	39725	30783	30823
7/32	5/8	2-1/2	1/4	30527	39727	30784	30824
15/64	3/4	2-1/2	1/4	30529	39729	30785	30825
1/4	3/4	2-1/2	1/4	30531	39731	30786	30826
17/64	3/4	2-1/2	5/16	30533	39733	30787	30827
9/32	3/4	2-1/2	5/16	30535	39735	30788	30828
19/64	13/16	2-1/2	5/16	30537	39737	30789	30829
5/16	13/16	2-1/2	5/16	30539	39739	30790	30830
21/64	1	2-1/2	3/8	30541	39741	30791	30831
11/32	1	2-1/2	3/8	30543	39743	30792	30832
23/64	1	2-1/2	3/8	30545	39745	30793	30833
3/8	1	2-1/2	3/8	30547	39747	30794	30834
25/64	1	2-3/4	7/16	30549	39749	30795	30835
13/32	1	2-3/4	7/16	30551	39751	30796	30836
27/64	1	2-3/4	7/16	30553	39753	30797	30837
7/16	1	2-3/4	7/16	30555	39755	30798	30838
29/64	1	3	1/2	30557	39757	30799	30839
15/32	1	3	1/2	30559	39759	30800	30840
31/64	1	3	1/2	30561	39761	30801	30841
1/2	1	3	1/2	30563	39763	30802	30842
9/16	1-1/8	3-1/2	9/16	30565	39765	30803	30843
5/8	1-1/4	3-1/2	5/8	30567	39767	30804	30844
11/16	1-3/8	4	3/4	30569	39769	30805	30845
3/4	1-1/2	4	3/4	30571	39771	30806	30846
7/8	1-1/2	4	7/8	30573	39773	30807	30847
1	1-1/2	4	1	30575	39775	30808	30848

FRACTIONAL 3 Flute Ball End

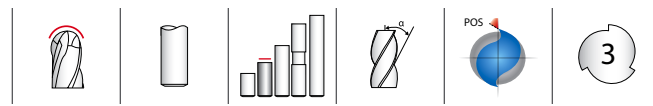

TOLERANCES (inch)
D₁ = +0.0000/-0.0020
D₂ = h₆
BALL RADIUS
 +0.0000/-0.0010

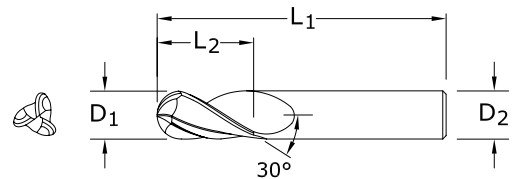

5B
 FRACTIONAL SERIES

inch				EDP NO.			
CUTTING DIAMETER D ₁	LENGTH OF CUT L ₂	OVERALL LENGTH L ₁	SHANK DIAMETER D ₂	UNCOATED	Ti-NAMITE (TiN)	Ti-NAMITE-C (TiCN)	Ti-NAMITE-A (AlTiN)
1/64	1/32	1-1/2	1/8	30502	30851	30602	31130
1/32	5/64	1-1/2	1/8	30504	30852	30604	31131
3/64	7/64	1-1/2	1/8	30506	30853	30606	31132
1/16	3/16	1-1/2	1/8	30508	30854	30608	31133
5/64	3/16	1-1/2	1/8	30510	30855	30610	31134
3/32	9/32	1-1/2	1/8	30512	30856	30612	31135
7/64	3/8	1-1/2	1/8	30514	30857	30902	31136
1/8	3/8	1-1/2	1/8	30578	30889	30943	31168
*1/8	1/2	1-1/2	1/8	30516	30858	30904	31137
9/64	1/2	2	3/16	30518	30859	30906	31138
5/32	1/2	2	3/16	30520	30860	30908	31139
11/64	5/8	2	3/16	30522	30861	30910	31140
*3/16	5/8	2	3/16	30524	30862	30912	31141
13/64	5/8	2-1/2	1/4	30526	30863	30914	31142
7/32	5/8	2-1/2	1/4	30528	30864	30916	31143
15/64	3/4	2-1/2	1/4	30530	30865	30918	31144
1/4	3/4	2-1/2	1/4	30532	30866	30920	31145
17/64	3/4	2-1/2	5/16	30534	30867	30921	31146
9/32	3/4	2-1/2	5/16	30536	30868	30922	31147
19/64	13/16	2-1/2	5/16	30538	30869	30923	31148
*5/16	13/16	2-1/2	5/16	30540	30870	30924	31149
21/64	1	2-1/2	3/8	30542	30871	30925	31150
11/32	1	2-1/2	3/8	30544	30872	30926	31151
23/64	1	2-1/2	3/8	30546	30873	30927	31152
*3/8	1	2-1/2	3/8	30548	30874	30928	31153
25/64	1	2-3/4	7/16	30550	30875	30929	31154
13/32	1	2-3/4	7/16	30552	30876	30930	31155
27/64	1	2-3/4	7/16	30554	30877	30931	31156
7/16	1	2-3/4	7/16	30556	30878	30932	31157
29/64	1	3	1/2	30558	30879	30933	31158
15/32	1	3	1/2	30560	30880	30934	31159
31/64	1	3	1/2	30562	30881	30935	31160
*1/2	1	3	1/2	30564	30882	30936	31161
9/16	1-1/8	3-1/2	9/16	30566	30883	30937	31162
5/8	1-1/4	3-1/2	5/8	30568	30884	30938	31163
11/16	1-3/8	4	3/4	30570	30885	30939	31164
3/4	1-1/2	4	3/4	30572	30886	30940	31165
7/8	1-1/2	4	7/8	30574	30887	30941	31166
1	1-1/2	4	1	30576	30888	30942	31167
*Series 5B Set				30590	30900	30944	31169

- STEELS
- STAINLESS STEELS
- CAST IRON
- HIGH TEMP ALLOYS
- TITANIUM
- HARDENED STEELS
- NON-FERROUS
- PLASTICS/COMPOSITES

For patent information visit
www.ksptpatents.com

Tapered Square End

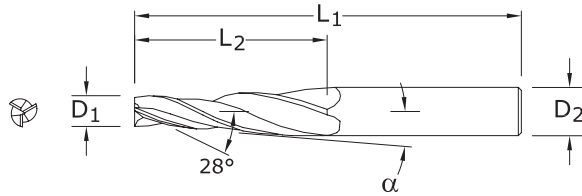
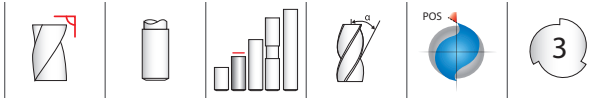

23
FRACTIONAL SERIES

TOLERANCES (inch)

D₁ = +0.0000/-0.0020
D₂ = h₆

- STEELS
- STAINLESS STEELS
- CAST IRON
- HIGH TEMP ALLOYS
- TITANIUM
- HARDENED STEELS
- NON-FERROUS
- PLASTICS/COMPOSITES

For patent information visit www.ksptpatents.com

inch					EDP NO.			
SHANK DIAMETER D ₂	CENTER LINE ANGLE α	SMALL DIAMETER D ₁	LENGTH OF CUT L ₂	OVERALL LENGTH L ₁	UNCOATED	Ti-NAMITE (TiN)	Ti-NAMITE-C (TiCN)	Ti-NAMITE-A (AlTiN)
1/4	1°	1/8	1-1/2	3	32301	32370	32302	32345
1/4	1°30'	1/8	1-1/2	3	32303	32371	32304	32346
1/4	2°	1/8	1-1/4	3	32305	32372	32306	32347
1/4	3°	1/8	1	3	32307	32373	32308	32348
1/4	5°	1/8	3/4	3	32309	32374	32310	32349
1/4	7°	1/8	1/2	3	32311	32375	32312	32350
1/4	10°	3/32	1/2	3	32313	32376	32314	32351
3/8	1°	3/16	1-3/4	3-1/2	32315	32377	32316	32352
3/8	1°30'	3/16	1-3/4	3-1/2	32317	32378	32318	32353
3/8	2°	3/16	1-3/4	3-1/2	32319	32379	32320	32354
3/8	3°	5/32	1-3/4	3-1/2	32321	32380	32322	32355
3/8	5°	1/8	1-1/2	3-1/2	32323	32381	32324	32356
3/8	7°	1/8	1	3-1/2	32325	32382	32326	32357
3/8	10°	1/8	3/4	3-1/2	32327	32383	32328	32358
1/2	1°	1/4	2	4	32329	32384	32330	32359
1/2	2°	1/4	2	4	32333	32385	32334	32360
1/2	3°	1/4	2	4	32335	32386	32336	32361
1/2	5°	1/4	1-1/4	4	32337	32387	32338	32362
1/2	7°	3/16	1-1/4	4	32339	32388	32340	32363
1/2	10°	1/8	1	4	32341	32389	32342	32364

Tapered Radius End

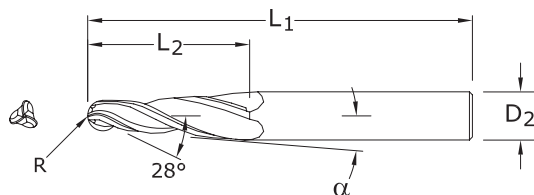

TOLERANCES (inch)

$D_2 = h_6$
 $R = +0.0005/-0.0010$

24
FRACTIONAL SERIES

SHANK DIAMETER D_2	CENTER LINE ANGLE α	inch			EDP NO.			
		RADIUS R	LENGTH OF CUT L_2	OVERALL LENGTH L_1	UNCOATED	Ti-NAMITE (TiN)	Ti-NAMITE-C (TiCN)	Ti-NAMITE-A (AlTiN)
1/4	1°	0.062	1-1/2	3	32402	32403	32445	32470
1/4	1°30'	0.062	1-1/2	3	32404	32405	32446	32471
1/4	2°	0.062	1-1/4	3	32406	32407	32447	32472
1/4	3°	0.062	1	3	32408	32409	32448	32473
1/4	5°	0.062	3/4	3	32410	32411	32449	32474
1/4	7°	0.062	1/2	3	32412	32413	32450	32475
1/4	10°	0.047	1/2	3	32414	32415	32451	32476
3/8	1°	0.093	1-3/4	3-1/2	32416	32417	32452	32477
3/8	1°30'	0.093	1-3/4	3-1/2	32418	32419	32453	32478
3/8	2°	0.093	1-3/4	3-1/2	32420	32421	32454	32479
3/8	3°	0.078	1-3/4	3-1/2	32422	32423	32455	32480
3/8	5°	0.062	1-1/2	3-1/2	32424	32425	32456	32481
3/8	7°	0.062	1	3-1/2	32426	32427	32457	32482
3/8	10°	0.062	3/4	3-1/2	32428	32429	32458	32483
1/2	1°	0.125	2	4	32430	32431	32459	32484
1/2	2°	0.125	2	4	32434	32435	32460	32485
1/2	3°	0.125	2	4	32436	32437	32461	32486
1/2	5°	0.125	1-1/4	4	32438	32439	32462	32487
1/2	7°	0.093	1-1/4	4	32440	32441	32463	32488
1/2	10°	0.062	1	4	32442	32443	32464	32489

- STEELS
- STAINLESS STEELS
- CAST IRON
- HIGH TEMP ALLOYS
- TITANIUM
- HARDENED STEELS
- NON-FERROUS
- PLASTICS/COMPOSITES

For patent information visit www.ksptpatents.com

4 Flute Square End Stub

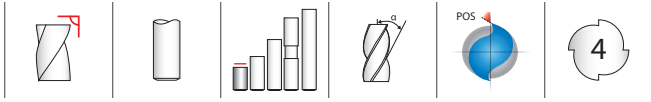

16
FRACTIONAL SERIES

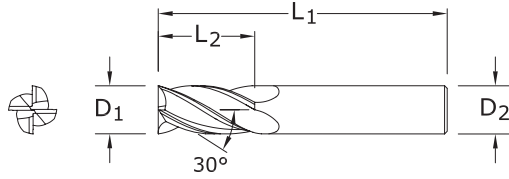

TOLERANCES (inch)

$D_1 = +0.0000/-0.0020$

$D_2 = h_6$

- STEELS
- STAINLESS STEELS
- CAST IRON
- HIGH TEMP ALLOYS
- TITANIUM
- HARDENED STEELS
- NON-FERROUS
- PLASTICS/COMPOSITES

CUTTING DIAMETER D_1	inch			EDP NO.			
	LENGTH OF CUT L_2	OVERALL LENGTH L_1	SHANK DIAMETER D_2	UNCOATED	Ti-NAMITE (TiN)	Ti-NAMITE-C (TiCN)	Ti-NAMITE-A (AlTiN)
1/16	1/8	1-1/2	1/8	31601	31650	31238	31251
3/32	3/16	1-1/2	1/8	31603	31651	31239	31252
1/8	1/4	1-1/2	1/8	31605	31652	31240	31253
5/32	5/16	2	3/16	31607	31653	31241	31254
3/16	3/8	2	3/16	31609	31654	31242	31255
7/32	7/16	2	1/4	31611	31655	31243	31256
1/4	1/2	2	1/4	31613	31656	31244	31257
5/16	1/2	2	5/16	31615	31657	31245	31258
3/8	5/8	2	3/8	31617	31658	31246	31259
7/16	5/8	2-1/2	7/16	31619	31659	31247	31260
1/2	5/8	2-1/2	1/2	31621	31660	31248	31261
5/8	3/4	3	5/8	31623	31661	31249	31262
3/4	1	3	3/4	31625	31662	31250	31263

For patent information visit www.ksptpatents.com

FRACTIONAL 4 Flute End Mills

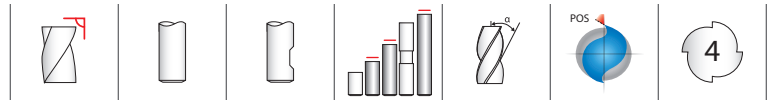

TOLERANCES (inch)

D₁ = +0.0000/-0.0020

D₂ = h₆

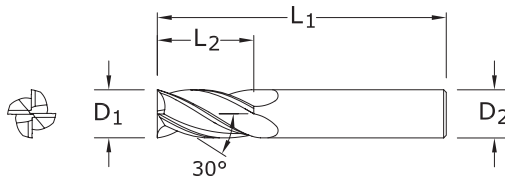

1·1L·1EL

FRACTIONAL SERIES

inch				EDP NO.							SERIES
CUTTING DIAMETER D ₁	LENGTH OF CUT L ₂	OVERALL LENGTH L ₁	SHANK DIAMETER D ₂	UNCOATED	UNCOATED W/ FLAT	Ti-NAMITE (TiN)	Ti-NAMITE-C (TiCN)	Ti-NAMITE-A (AlTiN)	Ti-NAMITE-A (AlTiN) W/FLAT	Di-NAMITE® (Diamond)	
1/64	1/32	1-1/2	1/8	30101	—	39101	39001	30191	—	—	1
1/32	5/64	1-1/2	1/8	30103	—	39103	39003	30192	—	—	1
3/64	7/64	1-1/2	1/8	30105	—	39105	39005	30193	—	—	1
1/16	3/16	1-1/2	1/8	30107	—	39107	39007	30194	—	91268	1
5/64	3/16	1-1/2	1/8	30109	—	39109	39009	30195	—	—	1
3/32	9/32	1-1/2	1/8	30111	—	39111	39011	30196	—	—	1
7/64	3/8	1-1/2	1/8	30113	—	39113	39013	30197	—	—	1
1/8	3/8	1-1/2	1/8	30177	—	39177	39077	30029	—	—	1
*1/8	1/2	1-1/2	1/8	30115	—	39115	39015	30198	—	91272	1
1/8	3/4	2-1/4	1/8	33141	—	31727	31737	31747	—	—	1L
1/8	1	3	1/8	33143	—	31860	31870	31880	—	—	1EL
9/64	1/2	2	3/16	30117	—	39117	39017	30199	—	—	1
5/32	1/2	2	3/16	30119	—	39119	39019	30000	—	—	1
11/64	5/8	2	3/16	30121	—	39121	39021	30001	—	—	1
*3/16	5/8	2	3/16	30123	—	39123	39023	30002	—	91276	1
3/16	3/4	2-1/2	3/16	33101	—	31728	31738	31748	—	—	1L
3/16	1-1/8	3	3/16	33121	—	31861	31871	31881	—	—	1EL
13/64	5/8	2-1/2	1/4	30125	—	39125	39025	30003	—	—	1
7/32	5/8	2-1/2	1/4	30127	—	39127	39027	30004	—	—	1
15/64	3/4	2-1/2	1/4	30129	—	39129	39029	30005	—	—	1
*1/4	3/4	2-1/2	1/4	30131	30300	39131	39031	30006	—	91280	1
1/4	1-1/8	3	1/4	33103	—	31729	31739	31749	—	—	1L
1/4	1-1/2	4	1/4	33123	—	31862	31872	31882	—	—	1EL
17/64	3/4	2-1/2	5/16	30133	—	39133	39033	30007	—	—	1
9/32	3/4	2-1/2	5/16	30135	—	39135	39035	30008	—	—	1
19/64	13/16	2-1/2	5/16	30137	—	39137	39037	30009	—	—	1
*5/16	13/16	2-1/2	5/16	30139	—	39139	39039	30010	—	91284	1
5/16	1-1/8	3	5/16	33105	—	31730	31740	31763	—	—	1L
5/16	1-5/8	4	5/16	33125	—	31863	31873	31883	—	—	1EL
21/64	1	2-1/2	3/8	30141	—	39141	39041	30011	—	—	1

continued on next page

- STEELS
- STAINLESS STEELS
- CAST IRON
- HIGH TEMP ALLOYS
- TITANIUM
- HARDENED STEELS
- NON-FERROUS
- PLASTICS/COMPOSITES

For patent information visit
www.ksptpatents.com

4 Flute End Mills

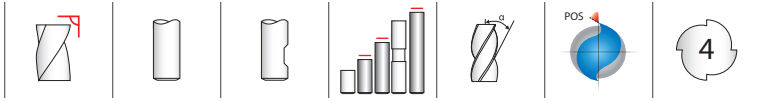

1·1L·1EL
FRACTIONAL SERIES

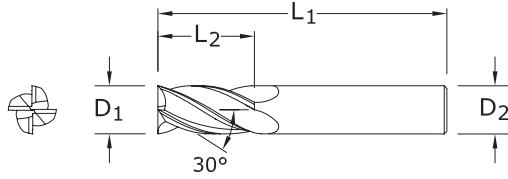

TOLERANCES (inch)

D₁ = +0.0000/-0.0020
D₂ = h₆

CONTINUED

- STEELS
- STAINLESS STEELS
- CAST IRON
- HIGH TEMP ALLOYS
- TITANIUM
- HARDENED STEELS
- NON-FERROUS
- PLASTICS/COMPOSITES

For patent information visit www.ksptpatents.com

inch				EDP NO.							SERIES
CUTTING DIAMETER D ₁	LENGTH OF CUT L ₂	OVERALL LENGTH L ₁	SHANK DIAMETER D ₂	UNCOATED	UNCOATED W/ FLAT	Ti-NAMITE (TiN)	Ti-NAMITE-C (TiCN)	Ti-NAMITE-A (AlTiN)	Ti-NAMITE-A (AlTiN) W/FLAT	Di-NAMITE® (Diamond)	
11/32	1	2-1/2	3/8	30143	—	39143	39043	30012	—	—	1
23/64	1	2-1/2	3/8	30145	—	39145	39045	30013	—	—	1
*3/8	1	2-1/2	3/8	30147	30179	39147	39047	30014	30379	91288	1
3/8	1-1/8	3	3/8	33107	—	31731	31741	31764	—	—	1L
3/8	1-3/4	4	3/8	33127	—	31864	31874	31884	—	—	1EL
25/64	1	2-3/4	7/16	30149	—	39149	39049	30015	—	—	1
13/32	1	2-3/4	7/16	30151	—	39151	39051	30016	—	—	1
27/64	1	2-3/4	7/16	30153	—	39153	39053	30017	—	—	1
7/16	1	2-3/4	7/16	30155	—	39155	39055	30018	—	—	1
7/16	2	4-1/2	7/16	33109	—	31732	31742	31765	—	—	1L
7/16	3	6	7/16	33129	—	31865	31875	31885	—	—	1EL
29/64	1	3	1/2	30157	—	39157	39057	30019	—	—	1
15/32	1	3	1/2	30159	—	39159	39059	30020	—	—	1
31/64	1	3	1/2	30161	—	39161	39061	30021	—	—	1
*1/2	1	3	1/2	30163	30180	39163	39063	30022	30380	91292	1
1/2	2	4-1/2	1/2	33111	—	31733	31743	31766	—	—	1L
1/2	3	6	1/2	33131	—	31866	31876	31886	—	—	1EL
9/16	1-1/8	3-1/2	9/16	30165	—	39165	39065	30023	—	—	1
5/8	1-1/4	3-1/2	5/8	30167	30181	39167	39067	30024	30381	—	1
5/8	2-1/4	5	5/8	33113	—	31734	31744	31767	—	—	1L
5/8	3	6	5/8	33133	—	31867	31877	31887	—	—	1EL
11/16	1-3/8	4	3/4	30169	—	39169	39069	30025	—	—	1
3/4	1-1/2	4	3/4	30171	30182	39171	39071	30026	30382	—	1
3/4	2-1/4	5	3/4	33115	—	31735	31745	31768	—	—	1L
3/4	3	6	3/4	33135	—	31868	31878	31888	—	—	1EL
7/8	1-1/2	4	7/8	30173	—	39173	39073	30027	—	—	1
1	1-1/2	4	1	30175	30183	39175	39075	30028	30383	—	1
1	2-1/4	5	1	33117	—	31736	31746	31769	—	—	1L
1	3	6	1	33137	—	31869	31879	31889	—	—	1EL
*Series 1 Set				30189	—	39189	39089	30030	—	—	1

FRACTIONAL 4 Flute Corner Radius

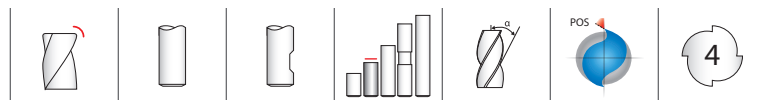

TOLERANCES (inch)

$D_1 = -0.0010/-0.0020$

$D_2 = h_6$

$R = +0.0000/-0.0020$

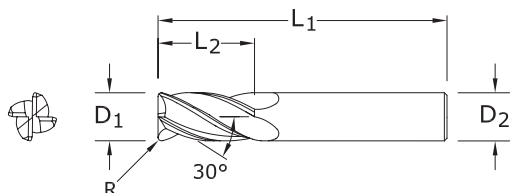

1CR
FRACTIONAL SERIES

CUTTING DIAMETER D_1	LENGTH OF CUT L_2	inch			EDP NO.			
		OVERALL LENGTH L_1	SHANK DIAMETER D_2	CORNER RADIUS R	UNCOATED	Ti-NAMITE (TiN)	Ti-NAMITE-C (TiCN)	Ti-NAMITE-A (AlTiN)
1/8*	1/2	1-1/2	1/8	.015	38001	38002	38115	38157
1/8*	1/2	1-1/2	1/8	.020	38003	38004	38116	38158
3/16*	5/8	2	3/16	.015	38009	38010	38117	38159
3/16*	5/8	2	3/16	.020	38011	38012	38118	38160
3/16*	5/8	2	3/16	.030	38013	38014	38119	38161
1/4*	3/4	2-1/2	1/4	.015	38019	38020	38120	38162
1/4*	3/4	2-1/2	1/4	.020	38021	38022	38121	38163
1/4*	3/4	2-1/2	1/4	.030	38023	38024	38122	38164
1/4*	3/4	2-1/2	1/4	.045	38025	38026	38123	38165
5/16*	13/16	2-1/2	5/16	.015	38031	38032	38124	38166
5/16*	13/16	2-1/2	5/16	.020	38033	38034	38125	38167
5/16*	13/16	2-1/2	5/16	.030	38035	38036	38126	38168
5/16*	13/16	2-1/2	5/16	.045	38037	38038	38127	38169
3/8	1	2-1/2	3/8	.015	38045	38046	38128	38170
3/8	1	2-1/2	3/8	.020	38047	38048	38129	38171
3/8	1	2-1/2	3/8	.030	38049	38050	38130	38172
3/8	1	2-1/2	3/8	.045	38051	38052	38131	38173
1/2	1	3	1/2	.015	38059	38060	38132	38174
1/2	1	3	1/2	.020	38061	38062	38133	38175
1/2	1	3	1/2	.030	38063	38064	38134	38176
1/2	1	3	1/2	.045	38065	38066	38135	38177
1/2	1	3	1/2	.060	38067	38068	38136	38178
5/8	1-1/4	3-1/2	5/8	.015	38073	38074	38137	38179
5/8	1-1/4	3-1/2	5/8	.020	38075	38076	38138	38180
5/8	1-1/4	3-1/2	5/8	.030	38077	38078	38139	38181
5/8	1-1/4	3-1/2	5/8	.045	38079	38080	38140	38182
5/8	1-1/4	3-1/2	5/8	.060	38081	38082	38141	38183
5/8	1-1/4	3-1/2	5/8	.090	38083	38084	38142	38184
3/4	1-1/2	4	3/4	.015	38087	38088	38143	38185
3/4	1-1/2	4	3/4	.020	38089	38090	38144	38186

- STEELS
- STAINLESS STEELS
- CAST IRON
- HIGH TEMP ALLOYS
- TITANIUM
- HARDENED STEELS
- NON-FERROUS
- PLASTICS/COMPOSITES

For patent information visit www.ksptpatents.com

*Without Flat

continued on next page

4 Flute Corner Radius

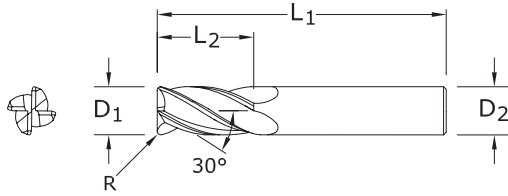
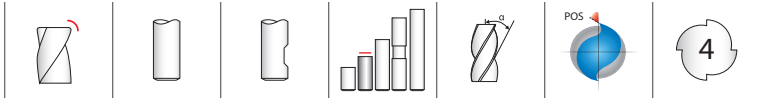

TOLERANCES (inch)

$D_1 = -0.0010/-0.0020$

$D_2 = h_6$

$R = +0.0000/-0.0020$

1CR
FRACTIONAL SERIES

CONTINUED

- STEELS
- STAINLESS STEELS
- CAST IRON
- HIGH TEMP ALLOYS
- TITANIUM
- HARDENED STEELS
- NON-FERROUS
- PLASTICS/COMPOSITES

CUTTING DIAMETER D_1	LENGTH OF CUT L_2	inch			EDP NO.			
		OVERALL LENGTH L_1	SHANK DIAMETER D_2	CORNER RADIUS R	UNCOATED	Ti-NAMITE (TiN)	Ti-NAMITE-C (TiCN)	Ti-NAMITE-A (AlTiN)
3/4	1-1/2	4	3/4	.030	38091	38092	38145	38187
3/4	1-1/2	4	3/4	.045	38093	38094	38146	38188
3/4	1-1/2	4	3/4	.060	38095	38096	38147	38189
3/4	1-1/2	4	3/4	.090	38097	38098	38148	38190
3/4	1-1/2	4	3/4	.125	38099	38100	38149	38191
1	1-1/2	4	1	.015	38101	38102	38150	38192
1	1-1/2	4	1	.020	38103	38104	38151	38193
1	1-1/2	4	1	.030	38105	38106	38152	38194
1	1-1/2	4	1	.045	38107	38108	38153	38195
1	1-1/2	4	1	.060	38109	38110	38154	38196
1	1-1/2	4	1	.090	38111	38112	38155	38197
1	1-1/2	4	1	.125	38113	38114	38156	38198

For patent information visit www.ksptpatents.com

4 Flute Double End Mills



TOLERANCES (inch)

$D_1 = +0.0000/-0.0020$

$D_2 = h_6$

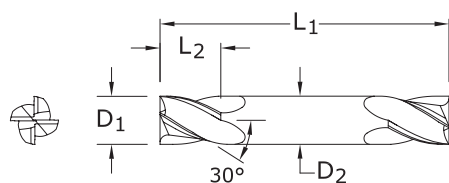

14
FRACTIONAL SERIES

inch				EDP NO.			
CUTTING DIAMETER D_1	LENGTH OF CUT L_2	OVERALL LENGTH L_1	SHANK DIAMETER D_2	UNCOATED	Ti-NAMITE (TiN)	Ti-NAMITE-C (TiCN)	Ti-NAMITE-A (AlTiN)
1/32	1/16	1-1/2	1/8	31401	31441	39601	31170
3/64	3/32	1-1/2	1/8	31403	31443	39603	31171
1/16	1/8	1-1/2	1/8	31405	31445	39605	31172
5/64	1/8	1-1/2	1/8	31407	31447	39607	31173
3/32	3/16	1-1/2	1/8	31409	31449	39609	31174
7/64	3/16	1-1/2	1/8	31411	31451	39611	31175
*1/8	1/4	1-1/2	1/8	31413	31453	39613	31176
9/64	5/16	2	3/16	31415	31455	39615	31177
5/32	5/16	2	3/16	31417	31457	39617	31178
11/64	5/16	2	3/16	31419	31459	39619	31179
*3/16	3/8	2	3/16	31421	31461	39621	31180
13/64	1/2	2-1/2	1/4	31423	31463	39623	31181
7/32	1/2	2-1/2	1/4	31425	31465	39625	31182
15/64	1/2	2-1/2	1/4	31427	31467	39627	31183
*1/4	1/2	2-1/2	1/4	31429	31469	39629	31184
9/32	1/2	2-1/2	5/16	31431	31471	39631	31185
*5/16	1/2	2-1/2	5/16	31433	31473	39633	31186
*3/8	9/16	2-1/2	3/8	31435	31475	39635	31187
7/16	9/16	2-3/4	7/16	31437	31477	39637	31188
*1/2	5/8	3	1/2	31439	31479	39639	31189
*Series 14 Set				31489	31481	39641	31190

- STEELS
- STAINLESS STEELS
- CAST IRON
- HIGH TEMP ALLOYS
- TITANIUM
- HARDENED STEELS
- NON-FERROUS
- PLASTICS/COMPOSITES

For patent information visit www.ksptpatents.com

4 Flute Ball End

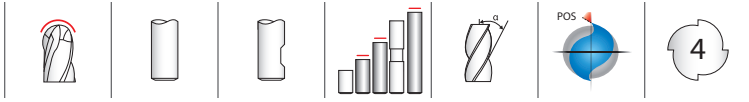

1B•1LB•1ELB
FRACTIONAL SERIES

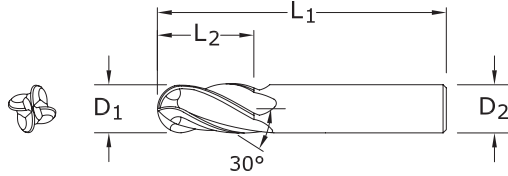

TOLERANCES (inch)

$D_1 = +0.0000/-0.0020$

$D_2 = h_6$

BALL RADIUS
 $+0.0000/-0.0010$

- STEELS
- STAINLESS STEELS
- CAST IRON
- HIGH TEMP ALLOYS
- TITANIUM
- HARDENED STEELS
- NON-FERROUS
- PLASTICS/COMPOSITES

For patent information visit www.ksptpatents.com

inch				EDP NO.							SERIES
CUTTING DIAMETER D_1	LENGTH OF CUT L_2	OVERALL LENGTH L_1	SHANK DIAMETER D_2	UNCOATED	UNCOATED W/FLAT	Ti-NAMITE (TiN)	Ti-NAMITE-C (TiCN)	Ti-NAMITE-A (AlTiN)	Ti-NAMITE-A (AlTiN) W/FLAT	Di-NAMITE® (Diamond)	
1/64	1/32	1-1/2	1/8	30102	—	39102	39002	30031	—	—	1B
1/32	5/64	1-1/2	1/8	30104	—	39104	39004	30032	—	—	1B
3/64	7/64	1-1/2	1/8	30106	—	39106	39006	30033	—	—	1B
1/16	3/16	1-1/2	1/8	30108	—	39108	39008	30034	—	91269	1B
5/64	3/16	1-1/2	1/8	30110	—	39110	39010	30035	—	—	1B
3/32	9/32	1-1/2	1/8	30112	—	39112	39012	30036	—	—	1B
7/64	3/8	1-1/2	1/8	30114	—	39114	39014	30037	—	—	1B
*1/8	3/8	1-1/2	1/8	30178	—	39178	39078	30069	—	—	1B
1/8	1/2	1-1/2	1/8	30116	—	39116	39016	30038	—	91273	1B
1/8	3/4	2-1/4	1/8	33142	—	31770	31780	31790	—	—	1LB
1/8	1	3	1/8	33144	—	31900	31918	31928	—	—	1ELB
9/64	1/2	2	3/16	30118	—	39118	39018	30039	—	—	1B
5/32	1/2	2	3/16	30120	—	39120	39020	30040	—	—	1B
11/64	5/8	2	3/16	30122	—	39122	39022	30041	—	—	1B
*3/16	5/8	2	3/16	30124	—	39124	39024	30042	—	—	1B
3/16	3/4	2-1/2	3/16	33102	—	31771	31781	31791	—	91277	1LB
3/16	1-1/8	3	3/16	33122	—	31902	31919	31929	—	—	1ELB
13/64	5/8	2-1/2	1/4	30126	—	39126	39026	30043	—	—	1B
7/32	5/8	2-1/2	1/4	30128	—	39128	39028	30044	—	—	1B
15/64	3/4	2-1/2	1/4	30130	—	39130	39030	30045	—	—	1B
*1/4	3/4	2-1/2	1/4	30132	—	39132	39032	30046	—	91281	1B
1/4	1-1/8	3	1/4	33104	—	31772	31782	31792	—	—	1LB
1/4	1-1/2	4	1/4	33124	—	31904	31920	31930	—	—	1ELB
17/64	3/4	2-1/2	5/16	30134	—	39134	39034	30047	—	—	1B
9/32	3/4	2-1/2	5/16	30136	—	39136	39036	30048	—	—	1B
19/64	13/16	2-1/2	5/16	30138	—	39138	39038	30049	—	—	1B
*5/16	13/16	2-1/2	5/16	30140	—	39140	39040	30050	—	91285	1B
5/16	1-1/8	3	5/16	33106	—	31773	31783	31793	—	—	1LB
5/16	1-5/8	4	5/16	33126	—	31906	31921	31931	—	—	1ELB
21/64	1	2-1/2	3/8	30142	—	39142	39042	30051	—	—	1B

continued on next page

FRACTIONAL
4 Flute Ball End

1B•1LB•1ELB
 FRACTIONAL SERIES

inch				EDP NO.							SERIES
CUTTING DIAMETER D ₁	LENGTH OF CUT L ₂	OVERALL LENGTH L ₁	SHANK DIAMETER D ₂	UNCOATED	UNCOATED W/FLAT	Ti-NAMITE (TiN)	Ti-NAMITE-C (TiCN)	Ti-NAMITE-A (AlTiN)	Ti-NAMITE-A (AlTiN) W/FLAT	Di-NAMITE® (Diamond)	
11/32	1	2-1/2	3/8	30144	—	39144	39044	30052	—	—	1B
23/64	1	2-1/2	3/8	30146	—	39146	39046	30053	—	—	1B
*3/8	1	2-1/2	3/8	30148	30184	39148	39048	30054	30384	91289	1B
3/8	1-1/8	3	3/8	33108	—	31774	31784	31794	—	—	1LB
3/8	1-3/4	4	3/8	33128	—	31908	31922	31932	—	—	1ELB
25/64	1	2-3/4	7/16	30150	—	39150	39050	30055	—	—	1B
13/32	1	2-3/4	7/16	30152	—	39152	39052	30056	—	—	1B
27/64	1	2-3/4	7/16	30154	—	39154	39054	30057	—	—	1B
7/16	1	2-3/4	7/16	30156	—	39156	39056	30058	—	—	1B
7/16	2	4-1/2	7/16	33110	—	31775	31785	31795	—	—	1LB
7/16	3	6	7/16	33130	—	31910	31923	31933	—	—	1ELB
29/64	1	3	1/2	30158	—	39158	39058	30059	—	—	1B
15/32	1	3	1/2	30160	—	39160	39060	30060	—	—	1B
31/64	1	3	1/2	30162	—	39162	39062	30061	—	—	1B
*1/2	1	3	1/2	30164	30185	39164	39064	30062	30385	91293	1B
1/2	2	4-1/2	1/2	33112	—	31776	31786	31796	—	—	1LB
1/2	3	6	1/2	33132	—	31912	31924	31934	—	—	1ELB
9/16	1-1/8	3-1/2	9/16	30166	—	39166	39066	30063	—	—	1B
5/8	1-1/4	3-1/2	5/8	30168	30186	39168	39068	30064	30386	—	1B
5/8	2-1/4	5	5/8	33114	—	31777	31787	31797	—	—	1LB
5/8	3	6	5/8	33134	—	31914	31925	31935	—	—	1ELB
11/16	1-3/8	4	3/4	30170	—	39170	39070	30065	—	—	1B
3/4	1-1/2	4	3/4	30172	30187	39172	39072	30066	30387	—	1B
3/4	2-1/4	5	3/4	33116	—	31778	31788	31798	—	—	1LB
3/4	3	6	3/4	33136	—	31916	31926	31936	—	—	1ELB
7/8	1-1/2	4	7/8	30174	—	39174	39074	30067	—	—	1B
1	1-1/2	4	1	30176	30188	39176	39076	30068	30388	—	1B
1	2-1/4	5	1	33118	—	31779	31789	31799	—	—	1LB
1	3	6	1	33138	—	31917	31927	31937	—	—	1ELB
*Series 1B Set				30190	—	39190	39090	30070	—	—	1B

CONTINUED

4 Flute Double End Ball End

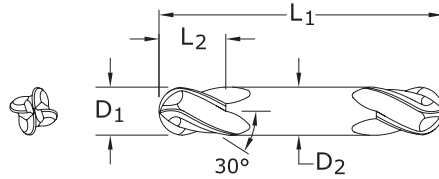
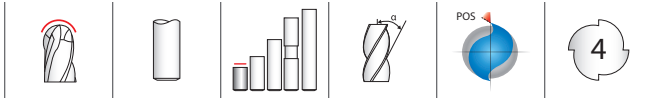

TOLERANCES (inch)

$D_1 = +0.0000/-0.0020$

$D_2 = h_6$

BALL RADIUS

$+0.0000/-0.0010$

14B

FRACTIONAL SERIES





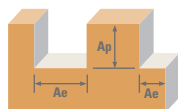

- STEELS
- STAINLESS STEELS
- CAST IRON
- HIGH TEMP ALLOYS
- TITANIUM
- HARDENED STEELS
- NON-FERROUS
- PLASTICS/COMPOSITES

For patent information visit www.ksptpatents.com

inch				EDP NO.			
CUTTING DIAMETER D_1	LENGTH OF CUT L_2	OVERALL LENGTH L_1	SHANK DIAMETER D_2	UNCOATED	Ti-NAMITE (TiN)	Ti-NAMITE-C (TiCN)	Ti-NAMITE-A (AlTiN)
1/32	1/16	1-1/2	1/8	31402	31442	39602	31218
3/64	3/32	1-1/2	1/8	31404	31444	39604	31219
1/16	1/8	1-1/2	1/8	31406	31446	39606	31220
5/64	1/8	1-1/2	1/8	31408	31448	39608	31221
3/32	3/16	1-1/2	1/8	31410	31450	39610	31222
7/64	3/16	1-1/2	1/8	31412	31452	39612	31223
*1/8	1/4	1-1/2	1/8	31414	31454	39614	31224
9/64	5/16	2	3/16	31416	31456	39616	31225
5/32	5/16	2	3/16	31418	31458	39618	31226
11/64	5/16	2	3/16	31420	31460	39620	31227
*3/16	3/8	2	3/16	31422	31462	39622	31228
13/64	1/2	2-1/2	1/4	31424	31464	39624	31229
7/32	1/2	2-1/2	1/4	31426	31466	39626	31230
15/64	1/2	2-1/2	1/4	31428	31468	39628	31231
*1/4	1/2	2-1/2	1/4	31430	31470	39630	31232
9/32	1/2	2-1/2	5/16	31432	31472	39632	31233
*5/16	1/2	2-1/2	5/16	31434	31474	39634	31234
*3/8	9/16	2-1/2	3/8	31436	31476	39636	31235
7/16	9/16	2-3/4	7/16	31438	31478	39638	31236
*1/2	5/8	3	1/2	31440	31480	39640	31237
*Series 14B Set				31490	31482	39642	31217

2 Flute: Square & Ball End 4 Flute: Square & Ball End



Diamond 1, 1B, 3, 3B Fractional	Ae x D ₁	Ap x D ₁	Vc (sfm)	Diameter (D ₁) (inch)							
				1/8	1/4	5/16	3/8	1/2			
GRAPHITE Ultrafine, Superfine	Profile  ≤ 0.25	≤ 1.5	720	RPM	22003	11002	8801	7334	5501		
			(576-864)	Fz	0.0009	0.0023	0.0036	0.0043	0.0058		
				Feed 2 flutes (ipm)	38.3	50.6	63.4	63.1	63.8		
				Feed 3 flutes (ipm)	76.6	101.2	126.7	126.2	127.6		
			Slot  ≤ 1	≤ 1	580	RPM	17725	8862	7090	5908	4431
					(464-696)	Fz	0.0075	0.0020	0.0031	0.0038	0.0050
	Feed 2 flutes (ipm)	265.9				35.4	44.0	44.9	44.3		
	COMPOSITES FRP, CFRP, GRP	Profile  ≤ 0.25	≤ 1.5	385	RPM	11766	5883	4706	3922	2941	
				(308-462)	Fz	0.0005	0.0014	0.0022	0.0026	0.0035	
Feed 2 flutes (ipm)					12.2	16.5	20.7	20.4	20.6		
Feed 3 flutes (ipm)					24.5	32.9	41.4	40.8	41.2		
Slot  ≤ 1				≤ 1	350	RPM	10696	5348	4278	3565	2674
					(280-420)	Fz	0.0005	0.0012	0.0019	0.0023	0.0030
		Feed 2 flutes (ipm)	9.6			12.8	16.3	16.4	16.0		
PLASTICS Polycarbonate, PVC, Polypropylene		Profile  ≤ 0.25	≤ 1.5	1200	RPM	36672	18336	14669	12224	9168	
				(960-1440)	Fz	0.0009	0.0023	0.0036	0.0043	0.0058	
	Feed 2 flutes (ipm)				63.8	84.3	105.6	105.1	106.3		
	Feed 3 flutes (ipm)				127.6	168.7	211.2	210.3	212.7		
	Slot  ≤ 1			≤ 1	960	RPM	29338	14669	11735	9779	7334
					(768-1152)	Fz	0.0008	0.0020	0.0031	0.0038	0.0050
Feed 2 flutes (ipm)		44.0	58.7			72.8	74.3	73.3			
Feed 3 flutes (ipm)	88.0	117.4	145.5	148.6	146.7						

rpm = (Vc x 3.82) / D₁

ipm = Fz x number of flutes x rpm

finish cuts typically require reduced feed and cut depths (.02 x D maximum)

refer to the KYOCERA SGS Tool Wizard® for complete technical information (www.kyocera-sgstool.com)

FRACTIONAL

2 Flute: Square, Double, Stub, Long, Ball, Corner Radius

3 Flute: Square, Ball, Tapered

4 Flute: Square, Double, Stub, Ball, Corner Radius

Tapered: Square, Radius

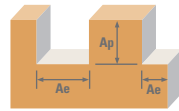

Series	Hardness	Flutes	Ae x D ₁	Ap x D ₁	Vc (sfm)	Diameter (D ₁) (inch)									
						1/64	1/32	1/16	1/8	1/4	3/8	1/2	3/4	1	
CARBON STEELS 1018, 1040, 1080, 1090, 10L50, 1140, 1212, 12L15, 1525, 1536	≤ 175 Bhn or ≤ 7 HRc	Profile	2 ≤ 0.50 ≤ 1.5 3 ≤ 0.25 ≤ 1.5 4 ≤ 0.25 ≤ 1.5	(368-552)	460 RPM	112461	56230	28115	14058	7029	4686	3514	2343	1757	
					Fz	0.00003	0.00006	0.00013	0.0003	0.0008	0.0015	0.0020	0.0024	0.0028	
					Feed (ipm)	6.7	6.7	7.3	8.4	11.2	14.1	14.1	11.2	9.8	
		Slot	2 1 ≤ 1 3 1 ≤ 0.5 4 1 ≤ 0.4	(268-402)	335 RPM	81901	40950	20475	10238	5119	3413	2559	1706	1280	
					Fz	0.00003	0.00006	0.00013	0.0003	0.0008	0.0015	0.0020	0.0024	0.0028	
					Feed (ipm)	4.9	4.9	5.3	6.1	8.2	10.2	10.2	8.2	7.2	
	ALLOY STEELS 4140, 4150, 4320, 5120, 5150, 8630, 86L20, 50100	≤ 275 Bhn or ≤ 28 HRc	Profile	2 ≤ 0.50 ≤ 1.5 3 ≤ 0.25 ≤ 1.5 4 ≤ 0.25 ≤ 1.5	(268-402)	335 RPM	81901	40950	20475	10238	5119	3413	2559	1706	1280
						Fz	0.00002	0.00005	0.00009	0.0002	0.0006	0.0011	0.0015	0.0018	0.0021
						Feed (ipm)	3.3	4.1	3.7	4.1	6.1	7.5	7.7	6.1	5.4
			Slot	2 1 ≤ 1 3 1 ≤ 0.5 4 1 ≤ 0.4	(196-294)	245 RPM	59898	29949	14974	7487	3744	2496	1872	1248	936
						Fz	0.00002	0.00005	0.00009	0.0002	0.0006	0.0011	0.0015	0.0018	0.0021
						Feed (ipm)	2.4	3.0	2.7	3.0	4.5	5.5	5.6	4.5	3.9
TOOL STEELS A2, D2, H13, L2, M2, P20, S7, T15, W2		≤ 250 Bhn or ≤ 24 HRc	Profile	2 ≤ 0.50 ≤ 1.5 3 ≤ 0.25 ≤ 1.5 4 ≤ 0.25 ≤ 1.5	(252-378)	315 RPM	77011	38506	19253	9626	4813	3209	2407	1604	1203
						Fz	0.00002	0.00005	0.00009	0.0002	0.0006	0.0011	0.0015	0.0018	0.0021
						Feed (ipm)	3.1	3.9	3.5	3.9	5.8	7.1	7.2	5.8	5.1
			Slot	2 1 ≤ 1 3 1 ≤ 0.5 4 1 ≤ 0.4	(184-276)	230 RPM	56230	28115	14058	7029	3514	2343	1757	1171	879
						Fz	0.00002	0.00005	0.00009	0.0002	0.0006	0.0011	0.0015	0.0018	0.0021
						Feed (ipm)	2.2	2.8	2.5	2.8	4.2	5.2	5.3	4.2	3.7
	CAST IRONS Gray, Malleable, Ductile	≤ 220 Bhn or ≤ 19 HRc	Profile	2 ≤ 0.50 ≤ 1.5 3 ≤ 0.25 ≤ 1.5 4 ≤ 0.25 ≤ 1.5	(268-402)	335 RPM	81901	40950	20475	10238	5119	3413	2559	1706	1280
						Fz	0.00003	0.00006	0.00013	0.0003	0.0008	0.0015	0.0020	0.0024	0.0028
						Feed (ipm)	4.9	4.9	5.3	6.1	8.2	10.2	10.2	8.2	7.2
			Slot	2 1 ≤ 1 3 1 ≤ 0.5 4 1 ≤ 0.4	(196-294)	245 RPM	59898	29949	14974	7487	3744	2496	1872	1248	936
						Fz	0.00003	0.00006	0.00013	0.0003	0.0008	0.0015	0.0020	0.0024	0.0028
						Feed (ipm)	3.6	3.6	3.9	4.5	6.0	7.5	7.5	6.0	5.2
STAINLESS STEELS (FREE MACHINING) 303, 416, 420F, 430F, 440F		≤ 275 Bhn or ≤ 28 HRc	Profile	2 ≤ 0.50 ≤ 1.5 3 ≤ 0.25 ≤ 1.5 4 ≤ 0.25 ≤ 1.5	(296-444)	370 RPM	90458	45229	22614	11307	5654	3769	2827	1885	1413
						Fz	0.00002	0.00005	0.00009	0.0002	0.0006	0.0011	0.0015	0.0018	0.0021
						Feed (ipm)	3.6	4.5	4.1	4.5	6.8	8.3	8.5	6.8	5.9
			Slot	2 1 ≤ 1 3 1 ≤ 0.5 4 1 ≤ 0.4	(216-324)	270 RPM	66010	33005	16502	8251	4126	2750	2063	1375	1031
						Fz	0.00002	0.00005	0.00009	0.0002	0.0006	0.0011	0.0015	0.0018	0.0021
						Feed (ipm)	2.6	3.3	3.0	3.3	5.0	6.1	6.2	5.0	4.3
	STAINLESS STEELS (DIFFICULT) 304, 304L, 316, 316L, 17-4 PH, 15-5, 13-4, Custom 450	≤ 275 Bhn or ≤ 28 HRc	Profile	2 ≤ 0.50 ≤ 1.5 3 ≤ 0.25 ≤ 1.5 4 ≤ 0.25 ≤ 1.5	(204-306)	255 RPM	62342	31171	15586	7793	3896	2598	1948	1299	974
						Fz	0.00002	0.00004	0.00008	0.0002	0.0005	0.0009	0.0012	0.0014	0.0017
						Feed (ipm)	2.5	2.5	2.5	2.6	3.9	4.7	4.7	3.6	3.3
			Slot	2 1 ≤ 1 3 1 ≤ 0.5 4 1 ≤ 0.4	(148-222)	185 RPM	45229	22614	11307	5654	2827	1885	1413	942	707
						Fz	0.00002	0.00004	0.00008	0.0002	0.0005	0.0009	0.0012	0.0014	0.0017
						Feed (ipm)	1.8	1.8	1.8	1.9	2.8	3.4	3.4	2.6	2.4

continued on next page

2 Flute: Square, Double, Stub, Long, Ball, Corner Radius
 3 Flute: Square, Ball, Tapered
 4 Flute: Square, Double, Stub, Ball, Corner Radius
 Tapered: Square, Radius

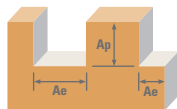

Series
 1, 3, 5, 14, 15, 16,
 17, 23, 24, 59
 Fractional

Diameter (D₁)
 (inch)

Series	Hardness	Flutes	Ae x D ₁	Ap x D ₁	Vc (sfm)	Diameter (D ₁) (inch)											
						1/64	1/32	1/16	1/8	1/4	3/8	1/2	3/4	1			
S SUPER ALLOYS (NICKEL, COBALT, IRON BASE) Inconel 601, 617, 625, 718, Incoloy 800, Monel 400, Rene, Waspalloy	≤ 300 Bhn or ≤ 32 HRC	Profile	2 ≤ 0.50 ≤ 1.5	3 ≤ 0.25 ≤ 1.5	65	RPM	15891	7946	3973	1986	993	662	497	331	248		
						Fz	0.00002	0.00003	0.00006	0.0002	0.0004	0.0008	0.0010	0.0012	0.0014		
						Feed (ipm)	0.6	0.5	0.5	0.7	0.7	1.1	1.0	0.8	0.7		
		Slot	2 1 ≤ 1	3 1 ≤ 0.5	4 1 ≤ 0.4	45	RPM	11002	5501	2750	1375	688	458	344	229	172	
							Fz	0.00002	0.00003	0.00006	0.0002	0.0004	0.0008	0.0010	0.0012	0.0014	
							Feed (ipm)	0.4	0.3	0.3	0.5	0.5	0.7	1.1	1.0	0.8	0.7
	TITANIUM ALLOYS Ti6Al4V, Ti6Al2Sn4Zr2Mo, Ti4Al4Mo2Sn0.5Si, Ti10Al2Fe3Al, Ti5Al53Mo3Cr, Ti7Al4Mo, Ti3Al8V6Cr4Zr4Mo, Ti6Al6V6Sn, Ti152Cr3Sn3Al	≤ 350 Bhn or ≤ 38 HRC	Profile	2 ≤ 0.50 ≤ 1.5	3 ≤ 0.25 ≤ 1.5	180	RPM	44006	22003	11002	5501	2750	1834	1375	917	688	
							Fz	0.00002	0.00004	0.00008	0.0002	0.0005	0.0009	0.0012	0.0014	0.0017	
							Feed (ipm)	1.8	1.8	1.8	2.2	2.8	3.3	3.3	2.6	2.3	
			Slot	2 1 ≤ 1	3 1 ≤ 0.5	4 1 ≤ 0.4	130	RPM	31782	15891	7946	3973	1986	1324	993	662	497
								Fz	0.00002	0.00004	0.00008	0.0002	0.0005	0.0009	0.0012	0.0014	0.0017
								Feed (ipm)	1.3	1.3	1.3	1.6	2.0	2.4	2.4	1.9	1.7
ALUMINUM ALLOYS 2017, 2024, 356, 6061, 7075		≤ 150 Bhn or ≤ 7 HRC	Profile	2 ≤ 0.50 ≤ 1.5	3 ≤ 0.25 ≤ 1.5	880	RPM	215142	107571	53786	26893	13446	8964	6723	4482	3362	
							Fz	0.00006	0.00013	0.00025	0.0006	0.0016	0.0030	0.0040	0.0048	0.0056	
							Feed (ipm)	25.8	28.0	26.9	32.3	43.0	53.8	53.8	43.0	37.6	
			Slot	2 1 ≤ 1	3 1 ≤ 0.5	640	RPM	156467	78234	39117	19558	9779	6519	4890	3260	2445	
							Fz	0.00006	0.00013	0.00025	0.0006	0.0016	0.0030	0.0040	0.0048	0.0056	
							Feed (ipm)	18.8	20.3	19.6	23.5	31.3	39.1	39.1	31.3	27.4	
	COPPER ALLOYS Alum Bronze, C110, Muntz Brass	≤ 140 Bhn or ≤ 3 HRC	Profile	2 ≤ 0.50 ≤ 1.5	3 ≤ 0.25 ≤ 1.5	485	RPM	118573	59286	29643	14822	7411	4941	3705	2470	1853	
							Fz	0.00003	0.00006	0.00013	0.0003	0.0008	0.0015	0.0020	0.0024	0.0028	
							Feed (ipm)	7.1	7.1	7.7	8.9	11.9	14.8	14.8	11.9	10.4	
			Slot	2 1 ≤ 1	3 1 ≤ 0.5	350	RPM	85568	42784	21392	10696	5348	3565	2674	1783	1337	
							Fz	0.00003	0.00006	0.00013	0.0003	0.0008	0.0015	0.0020	0.0024	0.0028	
							Feed (ipm)	5.1	5.1	5.6	6.4	8.6	10.7	10.7	8.6	7.5	
N PLASTICS Polycarbonate, PVC, Polypropylene			Profile	2 ≤ 0.50 ≤ 1.5	3 ≤ 0.25 ≤ 1.5	880	RPM	215142	107571	53786	26893	13446	8964	6723	4482	3362	
							Fz	0.00006	0.00013	0.00025	0.0006	0.0016	0.0030	0.0040	0.0048	0.0056	
							Feed (ipm)	25.8	28.0	26.9	32.3	43.0	53.8	53.8	43.0	37.6	
			Slot	2 1 ≤ 1	3 1 ≤ 0.5	640	RPM	156467	78234	39117	19558	9779	6519	4890	3260	2445	
							Fz	0.00006	0.00013	0.00025	0.0006	0.0016	0.0030	0.0040	0.0048	0.0056	
							Feed (ipm)	18.8	20.3	19.6	23.5	31.3	39.1	39.1	31.3	27.4	
	GRAPHITE		Profile	2 ≤ 0.50 ≤ 1.5	3 ≤ 0.25 ≤ 1.5	660	RPM	161357	80678	40339	20170	10085	6723	5042	3362	2521	
							Fz	0.00006	0.00013	0.00025	0.0006	0.0016	0.0030	0.0040	0.0048	0.0056	
							Feed (ipm)	19.4	21.0	20.2	24.2	32.3	40.3	40.3	32.3	28.2	
			Slot	2 1 ≤ 1	3 1 ≤ 0.5	480	RPM	117350	58675	29338	14669	7334	4890	3667	2445	1834	
							Fz	0.00006	0.00013	0.00025	0.0006	0.0016	0.0030	0.0040	0.0048	0.0056	
							Feed (ipm)	14.1	15.3	14.7	17.6	23.5	29.3	29.3	23.5	20.5	

Bhn (Brinell) HRC (Rockwell C)
 rpm = (Vc x 3.82) / D₁
 ipm = Fz x number of flutes x rpm
 reduce speed and feed for materials harder than listed
 for tapered end mills, base the speed on the largest diameter contacting
 the workpiece and the feed on the smallest diameter

limit cut depths of long and extra long flute mills to .05 x D₁ when slotting
 or profiling
 reduce feed and Ae when finish milling (.02 x D₁ maximum)
 refer to the KYOCERA SGS Tool Wizard® for complete technical information
 (www.kyocera-sgstool.com)

Single End Roughers (Fine Pitch)

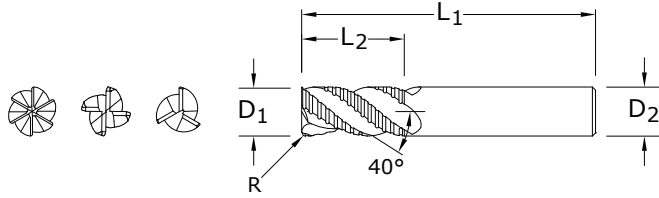
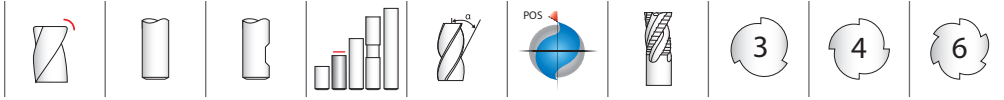

62
FRACTIONAL SERIES

TOLERANCES (inch)

$D_1 = +0.0000/-0.0040$

$D_2 = h_6$

$R = +0.0050/-0.0050$

CUTTING DIAMETER D_1	LENGTH OF CUT L_2	inch			CORNER RADIUS R	NO. OF FLUTES	EDP NO.		
		OVERALL LENGTH L_1	SHANK DIAMETER D_2				Ti-NAMITE (TiN)	Ti-NAMITE-C (TiCN)	Ti-NAMITE-A (AlTiN)
1/4*	3/4	2-1/2	1/4	.045	3	36207	36206	36210	
5/16*	3/4	2-1/2	5/16	.045	3	36209	36208	36211	
3/8	7/8	2-1/2	3/8	.060	3	36213	36212	36214	
1/2	1	3	1/2	.060	4	36217	36216	36218	
5/8	1-1/4	3-1/2	5/8	.060	4	36221	36220	36222	
3/4	1-5/8	4	3/4	.060	4	36225	36224	36226	
1	1-3/4	4	1	.060	6	36229	36228	36230	

*Without Flat

- STAINLESS STEELS
- HIGH TEMP ALLOYS
- TITANIUM

For patent information visit www.ksptpatents.com

Single End Roughers (Fine Pitch)

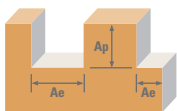

Series 62	Fractional	Hardness	Ae x D ₁	Ap x D ₁	Vc (sfm)	Diameter (D ₁) (inch)						
						1/4	3/8	1/2	3/4	1		
M	STAINLESS STEELS (FREE MACHINING) 303, 416, 420F, 430F, 440F	≤ 275 Bhn or ≤ 28 HRc	Profile 	≤ 0.5	≤ 1.5	405	RPM	6188	4126	3094	2063	1547
						(324-486)	Fz	0.0006	0.0011	0.0015	0.0019	0.0021
						Feed (ipm)	11.1	13.6	18.6	15.7	19.5	
			Slot 	1	≤ 1	325	RPM	4966	3311	2483	1655	1242
						(260-390)	Fz	0.0006	0.0011	0.0015	0.0019	0.0021
						Feed (ipm)	8.9	10.9	14.9	12.6	15.6	
	STAINLESS STEELS (DIFFICULT) 304, 304L, 316, 316L, 17-4PH, 15-5PH, 13-4PH, Custom 450	≤ 275 Bhn or ≤ 28 HRc	Profile 	≤ 0.5	≤ 1.5	280	RPM	4278	2852	2139	1426	1070
						(224-336)	Fz	0.0005	0.0009	0.0012	0.0015	0.0017
						Feed (ipm)	6.4	7.7	10.3	8.6	10.9	
			Slot 	1	≤ 1	225	RPM	3438	2292	1719	1146	860
						(180-270)	Fz	0.0005	0.0009	0.0012	0.0015	0.0017
						Feed (ipm)	5.2	6.2	8.3	6.9	8.8	
S	SUPER ALLOYS (NICKEL, COBALT, IRON BASE) Inconel 601, 617, 625, Incoloy 800, Monel 400, Rene, Waspalloy	≤ 300 Bhn or ≤ 32 HRc	Profile 	≤ 0.5	≤ 1.5	70	RPM	1070	713	535	357	267
						(56-84)	Fz	0.0004	0.0008	0.0010	0.0013	0.0014
						Feed (ipm)	1.3	1.7	2.1	1.9	2.2	
			Slot 	1	≤ 1	56	RPM	856	570	428	285	214
						(45-67)	Fz	0.0004	0.0008	0.0010	0.0013	0.0014
						Feed (ipm)	1.0	1.4	1.7	1.5	1.8	
	TITANIUM ALLOYS Ti6Al4V, Ti6Al2Sn4Zr2Mo, Ti4Al4Mo2Sn0.5Si, Ti10Al2Fe3Al, Ti5Al3Mo3Cr, Ti7Al4Mo, Ti3Al8V6Cr4Zr4Mo, Ti6Al6V6Sn, Ti152 Cr3Sn3Al	≤ 350 Bhn or ≤ 38 HRc	Profile 	≤ 0.5	≤ 1.5	155	RPM	2368	1579	1184	789	592
						(124-186)	Fz	0.0005	0.0009	0.0012	0.0015	0.0017
						Feed (ipm)	3.6	4.3	5.7	4.7	6.0	
			Slot 	1	≤ 1	195	RPM	2980	1986	1490	993	745
						(156-234)	Fz	0.0005	0.0009	0.0012	0.0015	0.0017
						Feed (ipm)	4.5	5.4	7.2	6.0	7.6	

Bhn (Brinell) HRc (Rockwell C)

$rpm = (Vc \times 3.82) / D_1$

$ipm = Fz \times \text{number of flutes} \times rpm$

reduce speed and feed for materials harder than listed

refer to the KYOCERA SGS Tool Wizard® for complete technical information (www.kyocera-sgstool.com)

Single End Roughers (Coarse Pitch)

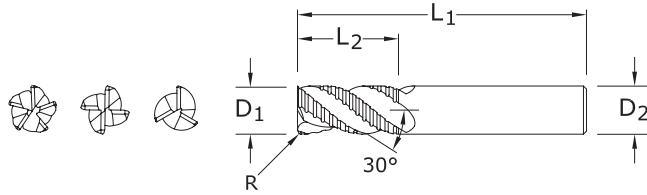
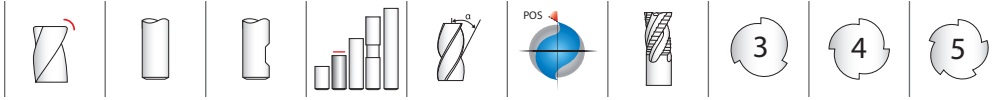

61
FRACTIONAL SERIES

TOLERANCES (inch)

D₁ = +0.0000/-0.0040

D₂ = h₆

R = +0.0050/-0.0050

CUTTING DIAMETER D ₁	LENGTH OF CUT L ₂	inch			NO. OF FLUTES	EDP NO.		
		OVERALL LENGTH L ₁	SHANK DIAMETER D ₂	CORNER RADIUS R		Ti-NAMITE (TiN)	Ti-NAMITE-C (TiCN)	Ti-NAMITE-A (AlTiN)
1/4*	3/4	2-1/2	1/4	.045	3	36107	36106	36110
5/16*	3/4	2-1/2	5/16	.045	3	36109	36108	36111
3/8	7/8	2-1/2	3/8	.060	3	36113	36112	36114
1/2	1	3	1/2	.060	4	36117	36116	36118
5/8	1-1/4	3-1/2	5/8	.060	4	36121	36120	36122
3/4	1-5/8	4	3/4	.060	4	36125	36124	36126
1	1-3/4	4	1	.060	5	36129	36128	36130







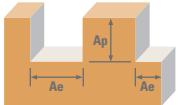

*Without Flat

- STEELS
- CAST IRON
- HARDENED STEELS

For patent information visit www.ksptpatents.com

Single End Roughers (Coarse Pitch)



Series 61	Fractional	Hardness	Ae x D ₁	Ap x D ₁	Vc (sfm)	Diameter (D ₁) (inch)						
						1/4	3/8	1/2	3/4	1		
P	CARBON STEELS 1018, 1040, 1080, 1090, 10L50, 1140, 1212, 12L15, 1525, 1536	≤ 175 Bhn or ≤ 7 HRc	Profile 	≤ 0.5	≤ 1.5	500	RPM	7640	5093	3820	2547	1910
						(400-600)	Fz	0.0006	0.0011	0.0014	0.0017	0.0020
							Feed (ipm)	13.8	16.8	21.4	17.3	19.1
			Slot 	1	≤ 1	400	RPM	6112	4075	3056	2037	1528
						(320-480)	Fz	0.0006	0.0011	0.0014	0.0017	0.0020
							Feed (ipm)	11.0	13.4	17.1	13.9	15.3
	ALLOY STEELS 4140, 4150, 4320, 5120, 5150, 8630, 86L20, 50100	≤ 275 Bhn or ≤ 28 HR	Profile 	≤ 0.5	≤ 1.5	365	RPM	5577	3718	2789	1859	1394
						(292-438)	Fz	0.0004	0.0008	0.0011	0.0013	0.0015
							Feed (ipm)	6.7	8.9	12.3	9.7	10.5
			Slot 	1	≤ 1	295	RPM	4508	3005	2254	1503	1127
						(236-354)	Fz	0.0004	0.0008	0.0011	0.0013	0.0015
							Feed (ipm)	5.4	7.2	9.9	7.8	8.5
H	TOOL STEELS A2, D2, H13, L2, M2, P20, S7, T15, W2	≤ 250 Bhn or ≤ 24 HRc	Profile 	≤ 0.5	≤ 1.5	345	RPM	5272	3514	2636	1757	1318
						(276-414)	Fz	0.0006	0.0009	0.0015	0.0018	0.0021
							Feed (ipm)	9.5	9.5	15.8	12.7	13.8
			Slot 	1	≤ 1	275	RPM	4202	2801	2101	1401	1051
						(220-330)	Fz	0.0006	0.0009	0.0015	0.0018	0.0021
							Feed (ipm)	7.6	7.6	12.6	10.1	11.0
K	CAST IRONS Gray, Malleable, Ductile	≤ 220 Bhn or ≤ 19 HRc	Profile 	≤ 0.5	≤ 1.5	365	RPM	5577	3718	2789	1859	1394
						(292-438)	Fz	0.0008	0.0015	0.0020	0.0024	0.0028
							Feed (ipm)	13.4	16.7	22.3	17.8	19.5
			Slot 	1	≤ 1	295	RPM	4508	3005	2254	1503	1127
						(236-354)	Fz	0.0008	0.0015	0.0020	0.0024	0.0028
							Feed (ipm)	10.8	13.5	18.0	14.4	15.8

Bhn (Brinell) HRc (Rockwell C)

$rpm = (Vc \times 3.82) / D_1$

$ipm = Fz \times \text{number of flutes} \times rpm$

reduce speed and feed for materials harder than listed

refer to the KYOCERA SGS Tool Wizard® for complete technical information (www.kyocera-sgstool.com)

2 Flute High Shear End Mills

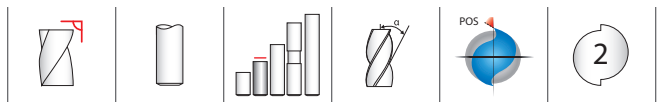

52
FRACTIONAL SERIES

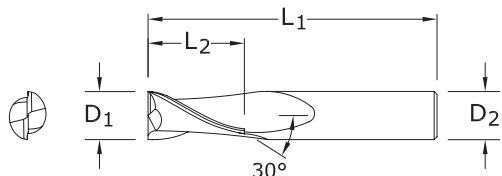

TOLERANCES (inch)

$D_1 = +0.0000/-0.0020$

$D_2 = h_6$

- NON-FERROUS
- PLASTICS/COMPOSITES

For patent information visit www.ksptpatents.com

CUTTING DIAMETER D_1	LENGTH OF CUT L_2	inch		EDP NO.	
		OVERALL LENGTH L_1	SHANK DIAMETER D_2	UNCOATED	Ti-NAMITE-C (TiCN)
1/16	3/16	1-1/2	1/8	35273	35300
3/32	3/8	1-1/2	1/8	35275	35301
1/8	7/16	1-1/2	1/8	35277	35302
5/32	9/16	2	3/16	35278	35303
3/16	9/16	2	3/16	35279	35304
7/32	5/8	2-1/2	1/4	35280	35305
1/4	3/4	2-1/2	1/4	35281	35306
9/32	3/4	2-1/2	5/16	35282	35307
5/16	13/16	2-1/2	5/16	35283	35308
3/8	7/8	2-1/2	3/8	35285	35309
7/16	1	2-3/4	7/16	35287	35310
1/2	1	3	1/2	35289	35311
9/16	1-1/8	3-1/2	9/16	35291	35312
5/8	1-1/4	3-1/2	5/8	35293	35313
3/4	1-1/2	4	3/4	35295	35314
1	1-1/2	4	1	35297	35315

4 Flute High Shear End Mills

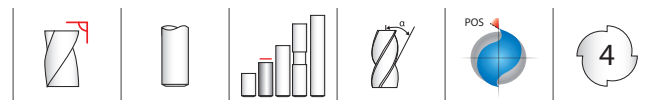

TOLERANCES (inch)
D1 = +0.0000/-0.0020
D2 = h₆

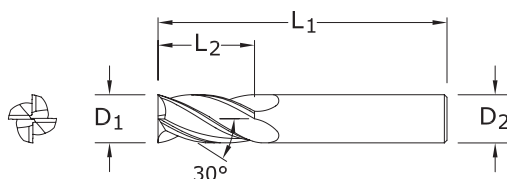

54
FRACTIONAL SERIES

CUTTING DIAMETER D ₁	LENGTH OF CUT L ₂	OVERALL LENGTH L ₁	SHANK DIAMETER D ₂	EDP NO.	
				UNCOATED	Ti-NAMITE-C (TiCN)
1/16	3/16	1-1/2	1/8	35473	35500
3/32	3/8	1-1/2	1/8	35475	35501
1/8	7/16	1-1/2	1/8	35477	35502
5/32	9/16	2	3/16	35478	35503
3/16	9/16	2	3/16	35479	35504
7/32	5/8	2-1/2	1/4	35480	35505
1/4	3/4	2-1/2	1/4	35481	35506
9/32	3/4	2-1/2	5/16	35482	35507
5/16	13/16	2-1/2	5/16	35483	35508
3/8	7/8	2-1/2	3/8	35485	35509
7/16	1	2-3/4	7/16	35487	35510
1/2	1	3	1/2	35489	35511
9/16	1-1/8	3-1/2	9/16	35491	35512
5/8	1-1/4	3-1/2	5/8	35493	35513
3/4	1-1/2	4	3/4	35495	35514
1	1-1/2	4	1	35497	35515

NON-FERROUS
 PLASTICS/COMPOSITES

For patent information visit www.ksptpatents.com

2 Flute: High Shear End Mills

4 Flute: High Shear End Mills

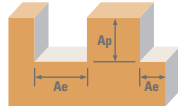

Series 52, 54 Fractional	Hardness	Flutes	Ae x D ₁	Ap x D ₁	Vc (sfm)	Diameter (D ₁) (inch)									
						1/8	1/4	3/8	1/2	3/4	1				
ALUMINUM ALLOYS 2024, 5052, 5086, 6061, 6063, 7075	≤ 150 Bhn or ≤ 7 HRc	Profile	2	≤ 0.3	≤ 1.5	1360	RPM	41562	20781	13854	10390	6927	5195		
						(1088-1632)	Fz	0.00069	0.0018	0.0034	0.0046	0.0055	0.0064		
		4	≤ 0.3	≤ 1.5	1090	RPM	33310	16655	11103	8328	5552	4164			
						(872-1308)	Fz	0.00063	0.0017	0.0032	0.0042	0.0050	0.0059		
		Slot	2	1	≤ 1	4	1	≤ 0.25	83.9	113.3	142.1	139.9	111.0	98.3	
															Feed (ipm)
		ALUMINUM DIE CAST ALLOYS (HIGH SILICON) A-390, A-392, B-390	≤ 125 Bhn or ≤ 77 HRb	Profile	2	≤ 0.3	≤ 1.5	510	RPM	15586	7793	5195	3896	2598	1948
								(408-612)	Fz	0.00069	0.0018	0.0034	0.0046	0.0055	0.0064
				4	≤ 0.3	≤ 1.5	410	RPM	12530	6265	4177	3132	2088	1566	
								(328-492)	Fz	0.00063	0.0017	0.0032	0.0042	0.0050	0.0059
Slot	2			1	≤ 1	4	1	≤ 0.25	15.8	21.3	26.7	26.3	20.9	18.5	
															Feed (ipm)
COPPER ALLOYS Aluminum Bronze, Muntz Brass, Naval, Brass, Red Brass	≤ 140 Bhn or ≤ 3 HRc			Profile	2	≤ 0.3	≤ 1.5	590	RPM	18030	9015	6010	4508	3005	2254
								(472-708)	Fz	0.00039	0.0010	0.0020	0.0026	0.0031	0.0037
				4	≤ 0.3	≤ 1.5	475	RPM	14516	7258	4839	3629	2419	1815	
								(380-570)	Fz	0.00036	0.0010	0.0018	0.0024	0.0029	0.0034
		Slot	2	1	≤ 1	4	1	≤ 0.25	10.5	14.5	17.4	17.4	14.0	12.3	
															Feed (ipm)
		COPPER ALLOYS Beryllium Copper, C110, Manganese Bronze, Tin Bronze	≤ 200 Bhn or ≤ 23 HRc	Profile	2	≤ 0.3	≤ 1.5	235	RPM	7182	3591	2394	1795	1197	898
								(188-282)	Fz	0.00039	0.0010	0.0020	0.0026	0.0031	0.0037
				4	≤ 0.3	≤ 1.5	190	RPM	5806	2903	1935	1452	968	726	
								(152-228)	Fz	0.00036	0.0010	0.0018	0.0024	0.0029	0.0034
Slot	2			1	≤ 1	4	1	≤ 0.25	4.2	5.8	7.0	7.0	5.6	4.9	
															Feed (ipm)
PLASTICS ABS, Polycarbonate, PVC, Polypropylene				Profile	2	≤ 0.3	≤ 1.5	1600	RPM	48896	24448	16299	12224	8149	6112
								(1280-1920)	Fz	0.00110	0.0030	0.0056	0.0074	0.0089	0.0100
				4	≤ 0.3	≤ 1.5	1280	RPM	39117	19558	13039	9779	6519	4890	
								(1024-1536)	Fz	0.00100	0.0027	0.0051	0.0068	0.0082	0.0095
		Slot	2	1	≤ 1	4	1	≤ 0.25	78.2	105.6	133.0	133.0	106.9	92.9	
															Feed (ipm)
		PLASTICS Fiberglass, Glass Filled		Profile	2	≤ 0.3	≤ 1.5	720	RPM	22003	11002	7334	5501	3667	2750
								(576-864)	Fz	0.00082	0.0022	0.0041	0.0055	0.0065	0.0076
				4	≤ 0.3	≤ 1.5	575	RPM	17572	8786	5857	4393	2929	2197	
								(460-690)	Fz	0.00075	0.0020	0.0037	0.0050	0.0060	0.0070
Slot	2			1	≤ 1	4	1	≤ 0.25	26.4	35.1	43.3	43.9	35.1	30.8	
															Feed (ipm)

Bhn (Brinell) HRc (Rockwell C) HRb (Rockwell B)
 rpm = (Vc x 3.82) / D₁
 ipm = Fz x number of flutes x rpm
 reduce speed and feed for materials harder than listed
 reduce feed and Ae when finish milling (.02 x D₁ maximum)
 refer to the KYOCERA SGS Tool Wizard® for complete technical information (www.kyocera-sgstool.com)

FRACTIONAL End Mills Sets

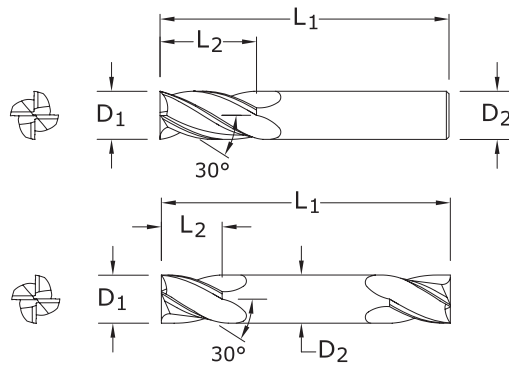

Pictured:
Series 1 4 Flute
Single End Square
Endmill Set

CUTTING DIAMETER D_1	SINGLE END LENGTH OF CUT L_2	DOUBLE END LENGTH OF CUT L_2	OVERALL LENGTH L_1	SHANK DIAMETER D_2
1/8	1/2	1/4	1-1/2	1/8
3/16	5/8	3/8	2	3/16
1/4	3/4	1/2	2-1/2	1/4
5/16	13/16	1/2	2-1/2	5/16
3/8	1	9/16	2-1/2	3/8
1/2	1	5/8	3	1/2

Square End FRACTIONAL SERIES

DESCRIPTION	EDP NO.			
	UNCOATED	Ti-NAMITE (TiN)	Ti-NAMITE-C (TiCN)	Ti-NAMITE-A (AlTiN)
Series 1 – 4 Flute, Single End	30189	39189	39089	30030
Series 3 – 2 Flute, Single End	30389	39389	39589	30470
Series 5 – 3 Flute, Single End	30589	39789	30810	30850
Series 14 – 4 Flute, Double End	31489	31481	39641	31190
Series 15 – 2 Flute, Double End	31589	31581	39691	31336



For patent information visit
www.ksptpatents.com

End Mills Sets

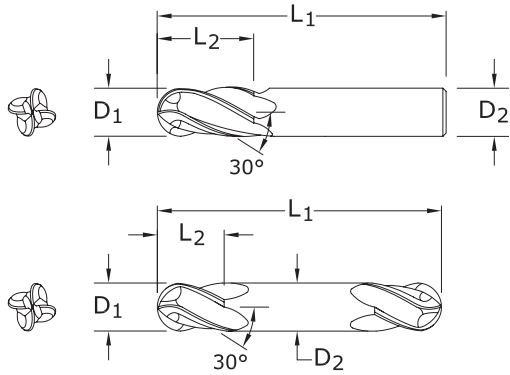

Pictured:
Series 1 4 Flute Single
End Ball Endmill Set

CUTTING DIAMETER D_1	SINGLE END LENGTH OF CUT L_2	DOUBLE END LENGTH OF CUT L_2	OVERALL LENGTH L_1	SHANK DIAMETER D_2
1/8	1/2	1/4	1-1/2	1/8
3/16	5/8	3/8	2	3/16
1/4	3/4	1/2	2-1/2	1/4
5/16	13/16	1/2	2-1/2	5/16
3/8	1	9/16	2-1/2	3/8
1/2	1	5/8	3	1/2

Ball End

FRACTIONAL SERIES



For patent information visit
www.ksptpatents.com

DESCRIPTION	EDP NO.			
	UNCOATED	Ti-NAMITE (TiN)	Ti-NAMITE-C (TiCN)	Ti-NAMITE-A (AlTiN)
Series 1B – 4 Flute, Single End	30190	39109	39090	30070
Series 3B – 2 Flute, Single End	30390	39390	39590	30600
Series 5B – 3 Flute, Single End	30590	30900	30944	31169
Series 14B – 4 Flute, Double End	31490	31482	39642	31217
Series 15B – 2 Flute, Double End	31590	31582	39692	31357

2 Flute Square End Stub

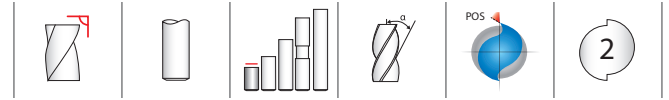

TOLERANCES (mm)

$D_1 = +0,000/-0,050$

$D_2 = h_6$

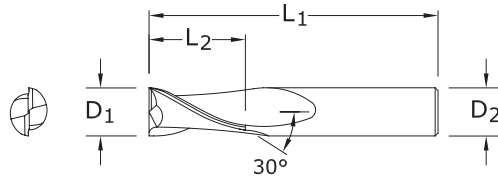

17M
METRIC SERIES

CUTTING DIAMETER D_1	LENGTH OF CUT L_2	OVERALL LENGTH L_1	SHANK DIAMETER D_2	EDP NO.			
				UNCOATED	Ti-NAMITE (TiN)	Ti-NAMITE-C (TiCN)	Ti-NAMITE-A (AlTiN)
1,0	2,0	38,0	3,0	41705	49262	49283	49304
1,5	3,0	38,0	3,0	41709	49263	49284	49305
2,0	4,0	38,0	3,0	41713	49264	49285	49306
2,5	5,0	38,0	3,0	41717	49265	49286	49307
3,0	6,0	38,0	3,0	41721	49266	49287	49308
3,5	7,0	50,0	4,0	41725	49267	49288	49309
4,0	8,0	50,0	4,0	41729	49268	49289	49310
4,5	9,5	50,0	4,5	41733	49269	49290	49311
5,0	10,0	50,0	5,0	41737	49270	49291	49312
6,0	12,0	50,0	6,0	41741	49271	49292	49313
7,0	12,0	50,0	8,0	41745	49272	49293	49314
8,0	12,0	50,0	8,0	41749	49273	49294	49315
9,0	14,0	50,0	9,0	41753	49274	49295	49316
10,0	16,0	50,0	10,0	41757	49275	49296	49317
11,0	19,0	63,0	12,0	41761	49276	49297	49318
12,0	19,0	63,0	12,0	41765	49277	49298	49319

- STEELS
- STAINLESS STEELS
- CAST IRON
- HIGH TEMP ALLOYS
- TITANIUM
- HARDENED STEELS
- NON-FERROUS
- PLASTICS/COMPOSITES

For patent information visit www.ksptpatents.com

METRIC

2 Flute Square End

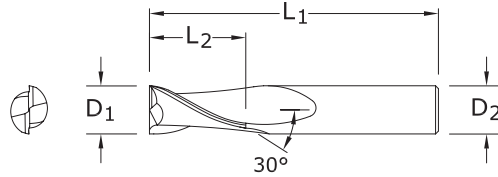
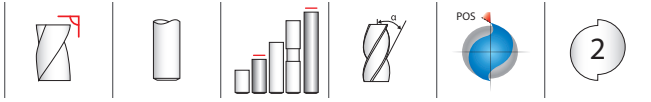

TOLERANCES (mm)

D₁ = +0,000/-0,050

D₂ = h₆

3M•3XLM
METRIC SERIES

- STEELS
- STAINLESS STEELS
- CAST IRON
- HIGH TEMP ALLOYS
- TITANIUM
- HARDENED STEELS
- NON-FERROUS
- PLASTICS/COMPOSITES

For patent information visit www.ksptpatents.com

mm				EDP NO.				SERIES
CUTTING DIAMETER D ₁	LENGTH OF CUT L ₂	OVERALL LENGTH L ₁	SHANK DIAMETER D ₂	UNCOATED	Ti-NAMITE (TiN)	Ti-NAMITE-C (TiCN)	Ti-NAMITE-A (AlTiN)	
1,0	4,0	38,0	3,0	40305	48628	48650	48671	3M
1,5	4,5	38,0	3,0	40309	48629	48651	48672	3M
2,0	6,3	38,0	3,0	40313	48630	48652	48673	3M
2,5	9,5	38,0	3,0	40317	48631	48653	48674	3M
3,0	12,0	38,0	3,0	40321	48632	48654	48675	3M
3,0	25,0	75,0	3,0	43301	49427	49440	49453	3XLM
3,5	12,0	50,0	4,0	40325	48633	48655	48676	3M
4,0	14,0	50,0	4,0	40329	48634	48656	48677	3M
4,0	25,0	75,0	4,0	43303	49428	49441	49454	3XLM
4,5	16,0	50,0	6,0	40333	48635	48657	48678	3M
5,0	16,0	50,0	6,0	40337	48636	48658	48679	3M
5,0	25,0	75,0	5,0	43307	49430	49443	49456	3XLM
6,0	19,0	50,0	6,0	40341	48637	48659	48680	3M
6,0	25,0	75,0	6,0	43305	49429	49442	49455	3XLM
7,0	19,0	63,0	8,0	40345	48638	48660	48681	3M
8,0	20,0	63,0	8,0	40349	48639	48661	48682	3M
8,0	25,0	75,0	8,0	43315	49431	49444	49457	3XLM
9,0	22,0	75,0	10,0	40353	48640	48662	48683	3M
10,0	22,0	75,0	10,0	40357	48641	48663	48684	3M
10,0	38,0	100,0	10,0	43325	49432	49445	49458	3XLM
11,0	25,0	75,0	12,0	40361	48642	48664	48685	3M
12,0	25,0	75,0	12,0	40365	48643	48665	48686	3M
12,0	50,0	100,0	12,0	43335	49433	49446	49459	3XLM
12,0	75,0	150,0	12,0	43345	49434	49447	49460	3XLM
14,0	32,0	89,0	14,0	40369	48644	48666	48687	3M
14,0	75,0	150,0	14,0	43355	49435	49448	49461	3XLM
16,0	32,0	89,0	16,0	40373	48645	48667	48688	3M
16,0	75,0	150,0	16,0	43365	49436	49449	49462	3XLM
18,0	38,0	100,0	18,0	40377	48646	48668	48689	3M
18,0	75,0	150,0	18,0	43375	49437	49450	49463	3XLM
20,0	38,0	100,0	20,0	40381	48647	48669	48690	3M
20,0	75,0	150,0	20,0	43385	49438	49451	49464	3XLM
25,0	38,0	100,0	25,0	40385	48648	48670	48691	3M
25,0	75,0	150,0	25,0	43395	49439	49452	49465	3XLM

2 Flute Square End Long Reach

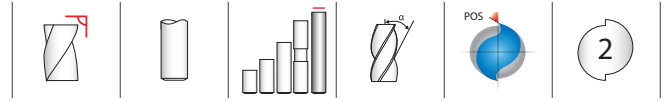

TOLERANCES (mm)

$D_1 = +0,000/-0,050$
 $D_2 = h_6$

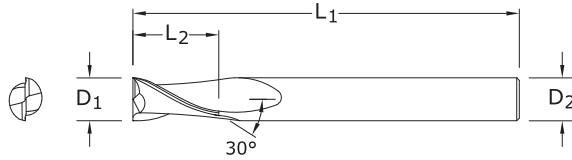

59M
 METRIC SERIES

mm				EDP NO.			
CUTTING DIAMETER D_1	LENGTH OF CUT L_2	OVERALL LENGTH L_1	SHANK DIAMETER D_2	UNCOATED	Ti-NAMITE (TiN)	Ti-NAMITE-C (TiCN)	Ti-NAMITE-A (AlTiN)
3,0	9,0	60,0	6,0	43910	43920	43930	43950
4,0	12,0	70,0	6,0	43911	43921	43931	43951
6,0	15,0	80,0	6,0	43912	43922	43932	43952
8,0	20,0	89,0	8,0	43913	43923	43933	43953
10,0	25,0	100,0	10,0	43914	43924	43934	43954
12,0	30,0	110,0	12,0	43915	43925	43935	43955
14,0	35,0	120,0	16,0	43916	43926	43936	43956
16,0	40,0	120,0	16,0	43917	43927	43937	43957
18,0	40,0	130,0	20,0	43918	43928	43938	43958
20,0	45,0	130,0	20,0	43919	43929	43939	43959

Neck Option Available

- STEELS
- STAINLESS STEELS
- CAST IRON
- HIGH TEMP ALLOYS
- TITANIUM
- HARDENED STEELS
- NON-FERROUS
- PLASTICS/COMPOSITES

For patent information visit www.ksptpatents.com

METRIC

2 Flute Double End Mills

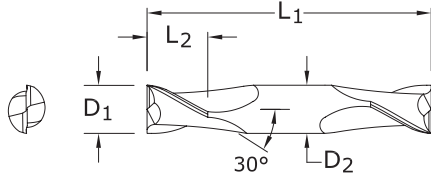
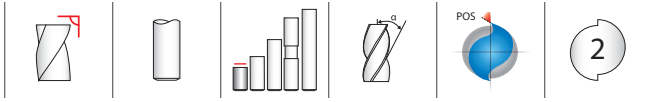

15M
METRIC SERIES

TOLERANCES (mm)

$D_1 = +0,000/-0,050$

$D_2 = h_6$

- STEELS
- STAINLESS STEELS
- CAST IRON
- HIGH TEMP ALLOYS
- TITANIUM
- HARDENED STEELS
- NON-FERROUS
- PLASTICS/COMPOSITES

mm				EDP NO.			
CUTTING DIAMETER D_1	LENGTH OF CUT L_2	OVERALL LENGTH L_1	SHANK DIAMETER D_2	UNCOATED	Ti-NAMITE (TiN)	Ti-NAMITE-C (TiCN)	Ti-NAMITE-A (AlTiN)
1,0	2,0	38,0	3,0	41505	49010	49031	49052
1,5	3,0	38,0	3,0	41509	49011	49032	49053
2,0	4,0	38,0	3,0	41513	49012	49033	49054
2,5	5,0	38,0	3,0	41517	49013	49034	49055
3,0	6,0	38,0	3,0	41521	49014	49035	49056
3,5	7,0	50,0	4,0	41525	49015	49036	49057
4,0	8,0	50,0	4,0	41529	49016	49037	49058
4,5	9,5	63,0	4,5	41533	49017	49038	49059
5,0	10,0	63,0	5,0	41537	49018	49039	49060
6,0	12,0	63,0	6,0	41541	49019	49040	49061
7,0	12,0	63,0	8,0	41545	49020	49041	49062
8,0	12,0	63,0	8,0	41549	49021	49042	49063
9,0	14,0	75,0	9,0	41553	49022	49043	49064
10,0	14,0	75,0	10,0	41557	49023	49044	49065
11,0	14,0	75,0	12,0	41561	49024	49045	49066
12,0	16,0	75,0	12,0	41565	49025	49046	49067

For patent information visit www.ksptpatents.com

2 Flute Ball End

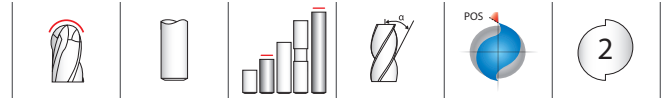

TOLERANCES (mm)

$D_1 = +0,000/-0,050$

$D_2 = h_6$

BALL RADIUS
+0,000/-0,025

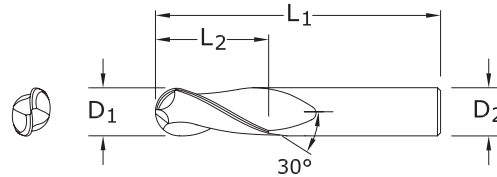

3MB•3XLMB

METRIC SERIES

mm				EDP NO.				SERIES
CUTTING DIAMETER D_1	LENGTH OF CUT L_2	OVERALL LENGTH L_1	SHANK DIAMETER D_2	UNCOATED	Ti-NAMITE (TiN)	Ti-NAMITE-C (TiCN)	Ti-NAMITE-A (AlTiN)	
1,0	4,0	38,0	3,0	40306	48692	48714	48735	3MB
1,5	4,5	38,0	3,0	40310	48693	48715	48736	3MB
2,0	6,3	38,0	3,0	40314	48694	48716	48737	3MB
2,5	9,5	38,0	3,0	40318	48695	48717	48738	3MB
3,0	12,0	38,0	3,0	40322	48696	48718	48739	3MB
3,0	25,0	75,0	3,0	43302	49544	49557	49570	3XLMB
3,5	12,0	50,0	4,0	40326	48697	48719	48740	3MB
4,0	14,0	50,0	4,0	40330	48698	48720	48741	3MB
4,0	25,0	75,0	4,0	43304	49545	49558	49571	3XLMB
4,5	16,0	50,0	6,0	40334	48699	48721	48742	3MB
5,0	16,0	50,0	6,0	40338	48700	48722	48743	3MB
5,0	25,0	75,0	5,0	43308	49547	49560	49573	3XLMB
6,0	19,0	50,0	6,0	40342	48701	48723	48744	3MB
6,0	25,0	75,0	6,0	43306	49546	49559	49572	3XLMB
7,0	19,0	63,0	8,0	40346	48702	48724	48745	3MB
8,0	20,0	63,0	8,0	40350	48703	48725	48746	3MB
8,0	25,0	75,0	8,0	43316	49548	49561	49574	3XLMB
9,0	22,0	75,0	10,0	40354	48704	48726	48747	3MB
10,0	22,0	75,0	10,0	40358	48705	48727	48748	3MB
10,0	38,0	100,0	10,0	43326	49549	49562	49575	3XLMB
11,0	25,0	75,0	12,0	40362	48706	48728	48749	3MB
12,0	25,0	75,0	12,0	40366	48707	48729	48750	3MB
12,0	50,0	100,0	12,0	43336	49550	49563	49576	3XLMB
12,0	75,0	150,0	12,0	43346	49551	49564	49577	3XLMB
14,0	32,0	89,0	14,0	40370	48708	48730	48751	3MB
14,0	75,0	150,0	14,0	43356	49552	49565	49578	3XLMB
16,0	32,0	89,0	16,0	40374	48709	48731	48752	3MB
16,0	75,0	150,0	16,0	43366	49553	49566	49579	3XLMB
18,0	38,0	100,0	18,0	40378	48710	48732	48753	3MB
18,0	75,0	150,0	18,0	43376	49554	49567	49580	3XLMB
20,0	38,0	100,0	20,0	40382	48711	48733	48754	3MB
20,0	75,0	150,0	20,0	43386	49555	49568	49581	3XLMB
25,0	38,0	100,0	25,0	40386	48712	48734	48755	3MB
25,0	75,0	150,0	25,0	43396	49556	49569	49582	3XLMB

- STEELS
- STAINLESS STEELS
- CAST IRON
- HIGH TEMP ALLOYS
- TITANIUM
- HARDENED STEELS
- NON-FERROUS
- PLASTICS/COMPOSITES

For patent information visit www.ksptpatents.com

METRIC

2 Flute Ball End Long Reach

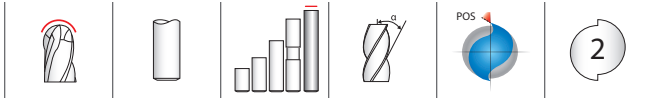

59MB
METRIC SERIES

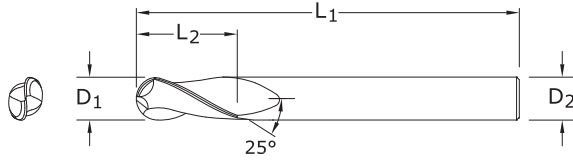

TOLERANCES (mm)

$D_1 = +0,000/-0,050$
 $D_2 = h_6$
BALL RADIUS
 $+0,000/-0,025$

- STEELS
- STAINLESS STEELS
- CAST IRON
- HIGH TEMP ALLOYS
- TITANIUM
- HARDENED STEELS
- NON-FERROUS
- PLASTICS/COMPOSITES

mm				EDP NO.			
CUTTING DIAMETER D_1	LENGTH OF CUT L_2	OVERALL LENGTH L_1	SHANK DIAMETER D_2	UNCOATED	Ti-NAMITE (TiN)	Ti-NAMITE-C (TiCN)	Ti-NAMITE-A (AlTiN)
3,0	9,0	60,0	6,0	43900	49622	49632	49642
4,0	12,0	70,0	6,0	43901	49623	49633	49643
6,0	15,0	80,0	6,0	43902	49624	49634	49644
8,0	20,0	89,0	8,0	43903	49625	49635	49645
10,0	25,0	100,0	10,0	43904	49626	49636	49646
12,0	30,0	110,0	12,0	43905	49627	49637	49647
14,0	35,0	120,0	16,0	43906	49628	49638	49648
16,0	40,0	120,0	16,0	43907	49629	49639	49649
18,0	40,0	130,0	20,0	43908	49630	49640	49650
20,0	45,0	130,0	20,0	43909	49631	49641	49651

Neck Option Available

For patent information visit www.ksptpatents.com

2 Flute Double End Ball End

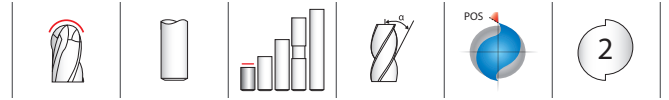

TOLERANCES (mm)

$D_1 = +0,000/-0,050$

$D_2 = h_6$

BALL RADIUS
 $+0,000/-0,025$

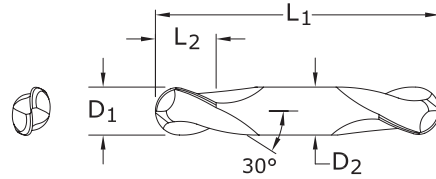

15MB
 METRIC SERIES

mm				EDP NO.			
CUTTING DIAMETER D_1	LENGTH OF CUT L_2	OVERALL LENGTH L_1	SHANK DIAMETER D_2	UNCOATED	Ti-NAMITE (TiN)	Ti-NAMITE-C (TiCN)	Ti-NAMITE-A (AlTiN)
1,0	2,0	38,0	3,0	41506	49073	49094	49115
1,5	3,0	38,0	3,0	41510	49074	49095	49116
2,0	4,0	38,0	3,0	41514	49075	49096	49117
2,5	5,0	38,0	3,0	41518	49076	49097	49118
3,0	6,0	38,0	3,0	41522	49077	49098	49119
3,5	7,0	50,0	4,0	41526	49078	49099	49120
4,0	8,0	50,0	4,0	41530	49079	49100	49121
4,5	9,5	63,0	4,5	41534	49080	49101	49122
5,0	10,0	63,0	5,0	41538	49081	49102	49123
6,0	12,0	63,0	6,0	41542	49082	49103	49124
7,0	12,0	63,0	8,0	41546	49083	49104	49125
8,0	12,0	63,0	8,0	41550	49084	49105	49126
9,0	14,0	75,0	9,0	41554	49085	49106	49127
10,0	14,0	75,0	10,0	41558	49086	49107	49128
11,0	14,0	75,0	12,0	41562	49087	49108	49129
12,0	16,0	75,0	12,0	41566	49088	49109	49130

- STEELS
- STAINLESS STEELS
- CAST IRON
- HIGH TEMP ALLOYS
- TITANIUM
- HARDENED STEELS
- NON-FERROUS
- PLASTICS/COMPOSITES

For patent information visit www.ksptpatents.com

3 Flute Square End

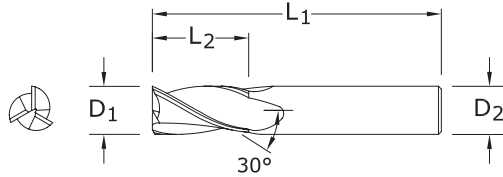
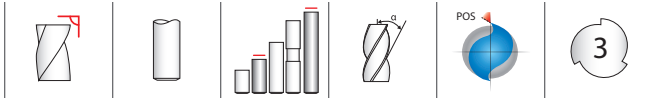

5M•5XLM
METRIC SERIES

TOLERANCES (mm)

D₁ = +0,000/-0,050
D₂ = h₆

- STEELS
- STAINLESS STEELS
- CAST IRON
- HIGH TEMP ALLOYS
- TITANIUM
- HARDENED STEELS
- NON-FERROUS
- PLASTICS/COMPOSITES

For patent information visit www.ksptpatents.com

mm				EDP NO.				SERIES
CUTTING DIAMETER D ₁	LENGTH OF CUT L ₂	OVERALL LENGTH L ₁	SHANK DIAMETER D ₂	UNCOATED	Ti-NAMITE (TiN)	Ti-NAMITE-C (TiCN)	Ti-NAMITE-A (AlTiN)	
1,0	4,0	38,0	3,0	40505	48756	48778	48799	5M
1,5	4,5	38,0	3,0	40509	48757	48779	48800	5M
2,0	6,3	38,0	3,0	40513	48758	48780	48801	5M
2,5	9,5	38,0	3,0	40517	48759	48781	48802	5M
3,0	12,0	38,0	3,0	40521	48760	48782	48803	5M
3,0	25,0	75,0	3,0	43501	49466	49479	49492	5XLM
3,5	12,0	50,0	4,0	40525	48761	48783	48804	5M
4,0	14,0	50,0	4,0	40529	48762	48784	48805	5M
4,0	25,0	75,0	4,0	43503	49467	49480	49493	5XLM
4,5	16,0	50,0	6,0	40533	48763	48785	48806	5M
5,0	16,0	50,0	6,0	40537	48764	48786	48807	5M
5,0	25,0	75,0	5,0	43507	49469	49482	49495	5XLM
6,0	19,0	50,0	6,0	40541	48765	48787	48808	5M
6,0	25,0	75,0	6,0	43505	49468	49481	49494	5XLM
7,0	19,0	63,0	8,0	40545	48766	48788	48809	5M
8,0	20,0	63,0	8,0	40549	48767	48789	48810	5M
8,0	25,0	75,0	8,0	43515	49470	49483	49496	5XLM
9,0	22,0	75,0	10,0	40553	48768	48790	48811	5M
10,0	22,0	75,0	10,0	40557	48769	48791	48812	5M
10,0	38,0	100,0	10,0	43525	49471	49484	49497	5XLM
11,0	25,0	75,0	12,0	40561	48770	48792	48813	5M
12,0	25,0	75,0	12,0	40565	48771	48793	48814	5M
12,0	50,0	100,0	12,0	43535	49472	49485	49498	5XLM
12,0	75,0	150,0	12,0	43545	49473	49486	49499	5XLM
14,0	32,0	89,0	14,0	40569	48772	48794	48815	5M
14,0	75,0	150,0	14,0	43555	49474	49487	49500	5XLM
16,0	32,0	89,0	16,0	40573	48773	48795	48816	5M
16,0	75,0	150,0	16,0	43565	49475	49488	49501	5XLM
18,0	38,0	100,0	18,0	40577	48774	48796	48817	5M
18,0	75,0	150,0	18,0	43575	49476	49489	49502	5XLM
20,0	38,0	100,0	20,0	40581	48775	48797	48818	5M
20,0	75,0	150,0	20,0	43585	49477	49490	49503	5XLM
25,0	38,0	100,0	25,0	40585	48776	48798	48819	5M
25,0	75,0	150,0	25,0	43595	49478	49491	49504	5XLM

3 Flute Ball End

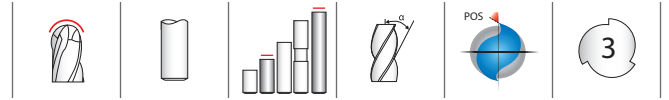

TOLERANCES (mm)

$D_1 = +0,000/-0,050$

$D_2 = h_6$

BALL RADIUS

$+0,000/-0,025$

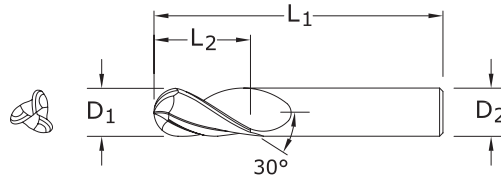

5MB•5XLMB

METRIC SERIES

mm				EDP NO.				SERIES
CUTTING DIAMETER D_1	LENGTH OF CUT L_2	OVERALL LENGTH L_1	SHANK DIAMETER D_2	UNCOATED	Ti-NAMITE (TiN)	Ti-NAMITE-C (TiCN)	Ti-NAMITE-A (AlTiN)	
1,0	4,0	38,0	3,0	40506	48820	48842	48863	5MB
1,5	4,5	38,0	3,0	40510	48821	48843	48864	5MB
2,0	6,3	38,0	3,0	40514	48822	48844	48865	5MB
2,5	9,5	38,0	3,0	40518	48823	48845	48866	5MB
3,0	12,0	38,0	3,0	40522	48824	48846	48867	5MB
3,0	25,0	75,0	3,0	43502	49583	49596	49609	5XLMB
3,5	12,0	50,0	4,0	40526	48825	48847	48868	5MB
4,0	14,0	50,0	4,0	40530	48826	48848	48869	5MB
4,0	25,0	75,0	4,0	43504	49584	49597	49610	5XLMB
4,5	16,0	50,0	6,0	40534	48827	48849	48870	5MB
5,0	16,0	50,0	6,0	40538	48828	48850	48871	5MB
5,0	25,0	75,0	5,0	43508	49586	49599	49612	5XLMB
6,0	19,0	50,0	6,0	40542	48829	48851	48872	5MB
6,0	25,0	75,0	6,0	43506	49585	49598	49611	5XLMB
7,0	19,0	63,0	8,0	40546	48830	48852	48873	5MB
8,0	20,0	63,0	8,0	40550	48831	48853	48874	5MB
8,0	25,0	75,0	8,0	43516	49587	49600	49613	5XLMB
9,0	22,0	75,0	10,0	40554	48832	48854	48875	5MB
10,0	22,0	75,0	10,0	40558	48833	48855	48876	5MB
10,0	38,0	100,0	10,0	43526	49588	49601	49614	5XLMB
11,0	25,0	75,0	12,0	40562	48834	48856	48877	5MB
12,0	25,0	75,0	12,0	40566	48835	48857	48878	5MB
12,0	50,0	100,0	12,0	43536	49589	49602	49615	5XLMB
12,0	75,0	150,0	12,0	43546	49590	49603	49616	5XLMB
14,0	32,0	89,0	14,0	40570	48836	48858	48879	5MB
14,0	75,0	150,0	14,0	43556	49591	49604	49617	5XLMB
16,0	32,0	89,0	16,0	40574	48837	48859	48880	5MB
16,0	75,0	150,0	16,0	43566	49592	49605	49618	5XLMB
18,0	38,0	100,0	18,0	40578	48838	48860	48881	5MB
18,0	75,0	150,0	18,0	43576	49593	49606	49619	5XLMB
20,0	38,0	100,0	20,0	40582	48839	48861	48882	5MB
20,0	75,0	150,0	20,0	43586	49594	49607	49620	5XLMB
25,0	38,0	100,0	25,0	40586	48840	48862	48883	5MB
25,0	75,0	150,0	25,0	43596	49595	49608	49621	5XLMB

- STEELS
- STAINLESS STEELS
- CAST IRON
- HIGH TEMP ALLOYS
- TITANIUM
- HARDENED STEELS
- NON-FERROUS
- PLASTICS/COMPOSITES

For patent information visit www.ksptpatents.com

METRIC

4 Flute Square End Stub

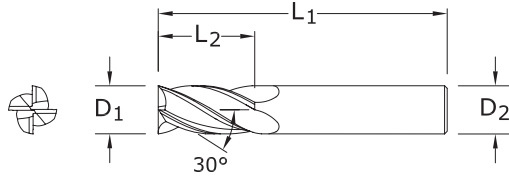
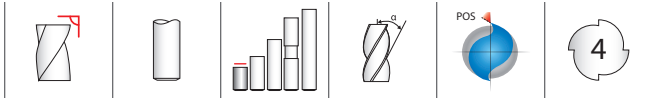

16M
METRIC SERIES

TOLERANCES (mm)

D₁ = +0,000/-0,050

D₂ = h₆

- STEELS
- STAINLESS STEELS
- CAST IRON
- HIGH TEMP ALLOYS
- TITANIUM
- HARDENED STEELS
- NON-FERROUS
- PLASTICS/COMPOSITES

CUTTING DIAMETER D ₁	mm			EDP NO.			
	LENGTH OF CUT L ₂	OVERALL LENGTH L ₁	SHANK DIAMETER D ₂	UNCOATED	Ti-NAMITE (TiN)	Ti-NAMITE-C (TiCN)	Ti-NAMITE-A (AlTiN)
1,0	2,0	38,0	3,0	41605	49136	49157	49178
1,5	3,0	38,0	3,0	41609	49137	49158	49179
2,0	4,0	38,0	3,0	41613	49138	49159	49180
2,5	5,0	38,0	3,0	41617	49139	49160	49181
3,0	6,0	38,0	3,0	41621	49140	49161	49182
3,5	7,0	50,0	4,0	41625	49141	49162	49183
4,0	8,0	50,0	4,0	41629	49142	49163	49184
4,5	9,5	50,0	4,5	41633	49143	49164	49185
5,0	10,0	50,0	5,0	41637	49144	49165	49186
6,0	12,0	50,0	6,0	41641	49145	49166	49187
7,0	12,0	50,0	8,0	41645	49146	49167	49188
8,0	12,0	50,0	8,0	41649	49147	49168	49189
9,0	14,0	50,0	9,0	41653	49148	49169	49190
10,0	16,0	50,0	10,0	41657	49149	49170	49191
11,0	19,0	63,0	12,0	41661	49150	49171	49192
12,0	19,0	63,0	12,0	40165	49151	49172	49193

For patent information visit www.ksptpatents.com

METRIC 4 Flute End Mills

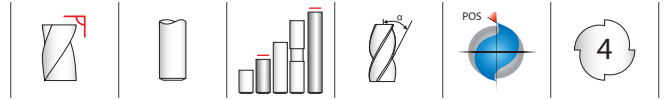

TOLERANCES (mm)

$D_1 = +0,000/-0,050$

$D_2 = h_6$

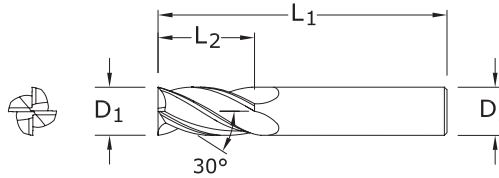

1M • 1XLM

METRIC SERIES

mm				EDP NO.				SERIES
CUTTING DIAMETER D_1	LENGTH OF CUT L_2	OVERALL LENGTH L_1	SHANK DIAMETER D_2	UNCOATED	Ti-NAMITE (TiN)	Ti-NAMITE-C (TiCN)	Ti-NAMITE-A (AlTiN)	
1,0	4,0	38,0	3,0	40105	48500	48522	48543	1M
1,5	4,5	38,0	3,0	40109	48501	48523	48544	1M
2,0	6,3	38,0	3,0	40113	48502	48524	48545	1M
2,5	9,5	38,0	3,0	40117	48503	48525	48546	1M
3,0	12,0	38,0	3,0	40121	48504	48526	48547	1M
3,0	25,0	75,0	3,0	43101	49388	49401	49414	1XLM
3,5	12,0	50,0	4,0	40125	48505	48527	48548	1M
4,0	14,0	50,0	4,0	40129	48506	48528	48549	1M
4,0	25,0	75,0	4,0	43103	49389	49402	49415	1XLM
4,5	16,0	50,0	6,0	40133	48507	48529	48550	1M
5,0	16,0	50,0	6,0	40137	48508	48530	48551	1M
5,0	25,0	75,0	5,0	43107	49391	49404	49417	1XLM
6,0	19,0	50,0	6,0	40141	48509	48531	48552	1M
6,0	25,0	75,0	6,0	43105	49390	49403	49416	1XLM
7,0	19,0	63,0	8,0	40145	48510	48532	48553	1M
8,0	20,0	63,0	8,0	40149	48511	48533	48554	1M
8,0	25,0	75,0	8,0	43115	49392	49405	49418	1XLM
9,0	22,0	75,0	10,0	40153	48512	48534	48555	1M
10,0	22,0	75,0	10,0	40157	48513	48535	48556	1M
10,0	38,0	100,0	10,0	43125	49393	49406	49419	1XLM
11,0	25,0	75,0	12,0	40161	48514	48536	48557	1M
12,0	25,0	75,0	12,0	41665	48515	48537	48558	1M
12,0	50,0	100,0	12,0	43135	49394	49407	49420	1XLM
12,0	75,0	150,0	12,0	43145	49395	49408	49421	1XLM
14,0	32,0	89,0	14,0	40169	48516	48538	48559	1M
14,0	75,0	150,0	14,0	43155	49396	49409	49422	1XLM
16,0	32,0	89,0	16,0	40173	48517	48539	48560	1M
16,0	75,0	150,0	16,0	43165	49397	49410	49423	1XLM
18,0	38,0	100,0	18,0	40177	48518	48540	48561	1M
18,0	75,0	150,0	18,0	43175	49398	49411	49424	1XLM
20,0	38,0	100,0	20,0	40181	48519	48541	48562	1M
20,0	75,0	150,0	20,0	43185	49399	49412	49425	1XLM
25,0	38,0	100,0	25,0	40185	48520	48542	48563	1M
25,0	75,0	150,0	25,0	43195	49400	49413	49426	1XLM

- STEELS
- STAINLESS STEELS
- CAST IRON
- HIGH TEMP ALLOYS
- TITANIUM
- HARDENED STEELS
- NON-FERROUS
- PLASTICS/COMPOSITES

For patent information visit www.ksptpatents.com

METRIC

4 Flute Corner Radius

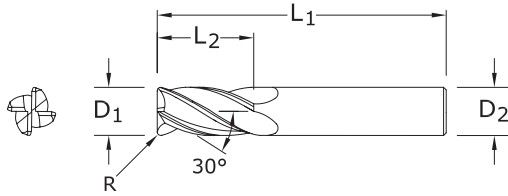
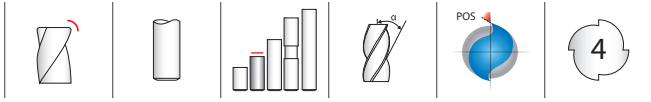

1MCR
METRIC SERIES

TOLERANCES (mm)

$D_1 = +0,000/-0,050$
 $D_2 = h_6$
 $R = +0,000/-0,050$

- STEELS
- STAINLESS STEELS
- CAST IRON
- HIGH TEMP ALLOYS
- TITANIUM
- HARDENED STEELS
- NON-FERROUS
- PLASTICS/COMPOSITES

For patent information visit www.ksptpatents.com

CUTTING DIAMETER D_1	LENGTH OF CUT L_2	mm			SHANK DIAMETER D_2	EDP NO. Ti-NAMITE-A (AITiN)
		OVERALL LENGTH L_1	CORNER RADIUS R			
4,0	14,0	50,0	0,25	4,0	40000	
4,0	14,0	50,0	0,50	4,0	40001	
4,0	14,0	50,0	1,00	4,0	40003	
5,0	16,0	50,0	0,25	6,0	40004	
5,0	16,0	50,0	0,50	6,0	40005	
5,0	16,0	50,0	1,00	6,0	40007	
6,0	19,0	50,0	0,25	6,0	40009	
6,0	19,0	50,0	0,50	6,0	40010	
6,0	19,0	50,0	0,75	6,0	40011	
6,0	19,0	50,0	1,00	6,0	40012	
8,0	20,0	63,0	0,50	8,0	40015	
8,0	20,0	63,0	0,75	8,0	40016	
8,0	20,0	63,0	1,00	8,0	40017	
8,0	20,0	63,0	1,50	8,0	40019	
8,0	20,0	63,0	2,00	8,0	40020	
10,0	22,0	75,0	0,50	10,0	40021	
10,0	22,0	75,0	1,00	10,0	40023	
10,0	22,0	75,0	1,50	10,0	40024	
10,0	22,0	75,0	2,00	10,0	40025	
12,0	25,0	75,0	0,50	12,0	40028	
12,0	25,0	75,0	1,00	12,0	40030	
12,0	25,0	75,0	1,50	12,0	40031	
12,0	25,0	75,0	2,00	12,0	40032	
16,0	32,0	89,0	0,50	16,0	40035	
16,0	32,0	89,0	1,00	16,0	40037	
16,0	32,0	89,0	1,50	16,0	40038	
16,0	32,0	89,0	2,00	16,0	40039	

4 Flute Double End Mills



TOLERANCES (mm)

$D_1 = +0,000/-0,050$

$D_2 = h_6$

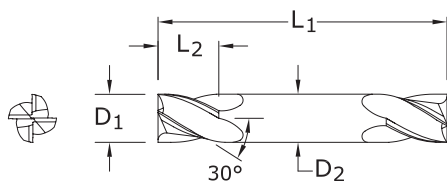

14M
METRIC SERIES

mm				EDP NO.			
CUTTING DIAMETER D_1	LENGTH OF CUT L_2	OVERALL LENGTH L_1	SHANK DIAMETER D_2	UNCOATED	Ti-NAMITE (TiN)	Ti-NAMITE-C (TiCN)	Ti-NAMITE-A (AlTiN)
1,0	2,0	38,0	3,0	41405	48884	48905	48926
1,5	3,0	38,0	3,0	41409	48885	48906	48927
2,0	4,0	38,0	3,0	41413	48886	48907	48928
2,5	5,0	38,0	3,0	41417	48887	48908	48929
3,0	6,0	38,0	3,0	41421	48888	48909	48930
3,5	7,0	50,0	4,0	41425	48889	48910	48931
4,0	8,0	50,0	4,0	41429	48890	48911	48932
4,5	9,5	63,0	4,5	41433	48891	48912	48933
5,0	10,0	63,0	5,0	41437	48892	48913	48934
6,0	12,0	63,0	6,0	41441	48893	48914	48935
7,0	12,0	63,0	8,0	41445	48894	48915	48936
8,0	12,0	63,0	8,0	41449	48895	48916	48937
9,0	14,0	75,0	9,0	41453	48896	48917	48938
10,0	14,0	75,0	10,0	41457	48897	48918	48939
11,0	14,0	75,0	12,0	41461	48898	48919	48940
12,0	16,0	75,0	12,0	41465	48899	48920	48941

- STEELS
- STAINLESS STEELS
- CAST IRON
- HIGH TEMP ALLOYS
- TITANIUM
- HARDENED STEELS
- NON-FERROUS
- PLASTICS/COMPOSITES

For patent information visit www.ksptpatents.com

4 Flute Ball End

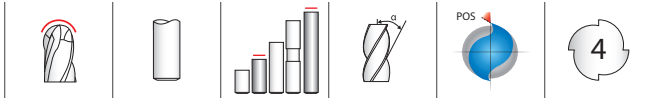

1MB•1XLMB

METRIC SERIES

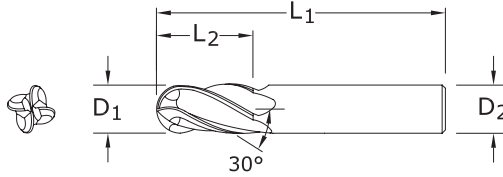

TOLERANCES (mm)

$D_1 = +0,000/-0,050$
 $D_2 = h_6$
BALL RADIUS
 $+0,000/-0,025$

- STEELS
- STAINLESS STEELS
- CAST IRON
- HIGH TEMP ALLOYS
- TITANIUM
- HARDENED STEELS
- NON-FERROUS
- PLASTICS/COMPOSITES

For patent information visit www.ksptpatents.com

mm				EDP NO.				SERIES
CUTTING DIAMETER D_1	LENGTH OF CUT L_2	OVERALL LENGTH L_1	SHANK DIAMETER D_2	UNCOATED	Ti-NAMITE (TiN)	Ti-NAMITE-C (TiCN)	Ti-NAMITE-A (AlTiN)	
1,0	4,0	38,0	3,0	40106	48564	48586	48607	1MB
1,5	4,5	38,0	3,0	40110	48565	48587	48608	1MB
2,0	6,3	38,0	3,0	40114	48566	48588	48609	1MB
2,5	9,5	38,0	3,0	40118	48567	48589	48610	1MB
3,0	12,0	38,0	3,0	40122	48568	48590	48611	1MB
3,0	25,0	75,0	3,0	43102	49505	49518	49531	1XLMB
3,5	12,0	50,0	4,0	40126	48569	48591	48612	1MB
4,0	14,0	50,0	4,0	40130	48570	48592	48613	1MB
4,0	25,0	75,0	4,0	43104	49506	49519	49532	1XLMB
4,5	16,0	50,0	6,0	40134	48571	48593	48614	1MB
5,0	16,0	50,0	6,0	40138	48572	48594	48615	1MB
5,0	25,0	75,0	5,0	43108	49508	49521	49534	1XLMB
6,0	19,0	50,0	6,0	40142	48573	48595	48616	1MB
6,0	25,0	75,0	6,0	43106	49507	49520	49533	1XLMB
7,0	19,0	63,0	8,0	40146	48574	48596	48617	1MB
8,0	20,0	63,0	8,0	40150	48575	48597	48618	1MB
8,0	25,0	75,0	8,0	43116	49509	49522	49535	1XLMB
9,0	22,0	75,0	10,0	40154	48576	48598	48619	1MB
10,0	22,0	75,0	10,0	40158	48577	48599	48620	1MB
10,0	38,0	100,0	10,0	43126	49510	49523	49536	1XLMB
11,0	25,0	75,0	12,0	40162	48578	48600	48621	1MB
12,0	25,0	75,0	12,0	40166	48579	48601	48622	1MB
12,0	50,0	100,0	12,0	43136	49511	49524	49537	1XLMB
12,0	75,0	150,0	12,0	43146	49512	49525	49538	1XLMB
14,0	32,0	89,0	14,0	40170	48580	48602	48623	1MB
14,0	75,0	150,0	14,0	43156	49513	49526	49539	1XLMB
16,0	32,0	89,0	16,0	40174	48581	48603	48624	1MB
16,0	75,0	150,0	16,0	43166	49514	49527	49540	1XLMB
18,0	38,0	100,0	18,0	40178	48582	48604	48625	1MB
18,0	75,0	150,0	18,0	43176	49515	49528	49541	1XLMB
20,0	38,0	100,0	20,0	40182	48583	48605	48626	1MB
20,0	75,0	150,0	20,0	43186	49516	49529	49542	1XLMB
25,0	38,0	100,0	25,0	40186	48584	48606	48627	1MB
25,0	75,0	150,0	25,0	43196	49517	49530	49543	1XLMB

4 Flute Double End Ball End

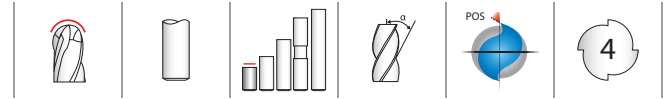

TOLERANCES (mm)

$D_1 = +0,000/-0,050$

$D_2 = h_6$

BALL RADIUS
+0,000/-0,025

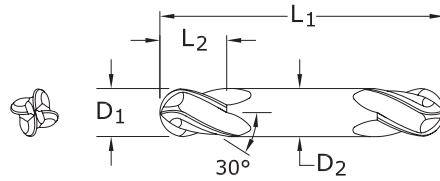

14MB
METRIC SERIES

mm				EDP NO.			
CUTTING DIAMETER D_1	LENGTH OF CUT L_2	OVERALL LENGTH L_1	SHANK DIAMETER D_2	UNCOATED	Ti-NAMITE (TiN)	Ti-NAMITE-C (TiCN)	Ti-NAMITE-A (AlTiN)
1,0	2,0	38,0	3,0	41406	48947	48968	48989
1,5	3,0	38,0	3,0	41410	48948	48969	48990
2,0	4,0	38,0	3,0	41414	48949	48970	48991
2,5	5,0	38,0	3,0	41418	48950	48971	48992
3,0	6,0	38,0	3,0	41422	48951	48972	48993
3,5	7,0	50,0	4,0	41426	48952	48973	48994
4,0	8,0	50,0	4,0	41430	48953	48974	48995
4,5	9,5	63,0	4,5	41434	48954	48975	48996
5,0	10,0	63,0	5,0	41438	48955	48976	48997
6,0	12,0	63,0	6,0	41442	48956	48977	48998
7,0	12,0	63,0	8,0	41446	48957	48978	48999
8,0	12,0	63,0	8,0	41450	48958	48979	49000
9,0	14,0	75,0	9,0	41454	48959	48980	49001
10,0	14,0	75,0	10,0	41458	48960	48981	49002
11,0	14,0	75,0	12,0	41462	48961	48982	49003
12,0	16,0	75,0	12,0	41466	48962	48983	49004

- STEELS
- STAINLESS STEELS
- CAST IRON
- HIGH TEMP ALLOYS
- TITANIUM
- HARDENED STEELS
- NON-FERROUS
- PLASTICS/COMPOSITES

For patent information visit www.ksptpatents.com

METRIC

2 Flute: Square, Double, Stub, Long Reach, Ball

3 Flute: Square, Long Reach, Ball

4 Flute: Square, Double, Stub, Long Reach, Ball, Corner Radius

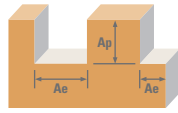

Series	Hardness	Flutes	Ae x D ₁	Ap x D ₁	V _c (m/min)	Diameter (D ₁) (mm)											
						0.4	0.75	1.5	3	6	10	12	20	25			
CARBON STEELS 1018, 1040, 1080, 1090, 10L50, 1140, 1212, 12L15, 1525, 1536	≤ 175 Bhn or ≤ 7 HRC	Profile	2 ≤ 0.50 ≤ 1.5	3 ≤ 0.25 ≤ 1.5	140	RPM	111483	59458	29729	14864	7432	4459	3716	2230	1784		
						Fz	0.0008	0.0015	0.0031	0.007	0.019	0.040	0.048	0.064	0.070		
						Feed (mm/min)	178	178	184	208	282	357	357	285	250		
							268	268	276	312	424	535	535	428	375		
							357	357	369	416	565	713	713	571	499		
						Slot	2 1 ≤ 1	3 1 ≤ 0.5	4 1 ≤ 0.4	102	RPM	81189	43301	21650	10825	5413	3248
		Fz	0.0008	0.0015	0.0031						0.007	0.019	0.040	0.048	0.064	0.070	
		Feed (mm/min)	130	130	134						152	206	260	260	208	182	
			195	195	201						227	309	390	390	312	273	
			260	260	268						303	411	520	520	416	364	
		ALLOY STEELS 4140, 4150, 4320, 5120, 5150, 8630, 86L20, 50100	≤ 275 Bhn or ≤ 28 HRC	Profile	2 ≤ 0.50 ≤ 1.5						3 ≤ 0.25 ≤ 1.5	102	RPM	81189	43301	21650	10825
						Fz	0.0005	0.0012	0.0022	0.006			0.014	0.029	0.036	0.048	0.052
Feed (mm/min)	81					104	95	130	152	188			195	156	135		
	122					156	143	195	227	283			292	234	203		
	162					208	191	260	303	377			390	312	270		
Slot	2 1 ≤ 1					3 1 ≤ 0.5	4 1 ≤ 0.4	75	RPM	59377			31668	15834	7917	3958	2375
				Fz	0.0005				0.0012	0.0022	0.006	0.014	0.029	0.036	0.048	0.052	
				Feed (mm/min)	59				76	70	95	111	138	143	114	99	
					119				152	139	190	222	276	285	228	198	
					119				152	139	190	222	276	285	228	198	
				TOOL STEELS A2, D2, H13, L2, M2, P20, S7, T15, W2	≤ 250 Bhn or ≤ 24 HRC				Profile	2 ≤ 0.50 ≤ 1.5	3 ≤ 0.25 ≤ 1.5	96	RPM	76342	40715	20358	10179
Fz	0.0005					0.0012	0.0022	0.006					0.014	0.029	0.036	0.048	0.052
Feed (mm/min)	76	98	90			122	143	177					183	147	127		
	115	147	134			183	214	266					275	220	191		
	153	195	179			244	285	354					366	293	254		
Slot	2 1 ≤ 1	3 1 ≤ 0.5	4 1 ≤ 0.4			70	RPM	55741					29729	14864	7432	3716	2230
							Fz	0.0005	0.0012	0.0022	0.006	0.014	0.029	0.036	0.048	0.052	
							Feed (mm/min)	56	71	65	89	104	129	134	107	93	
								84	107	98	134	156	194	201	161	139	
								111	143	131	178	208	259	268	214	186	
							CAST IRONS Gray, Malleable, Ductile	≤ 220 Bhn or ≤ 19 HRC	Profile	2 ≤ 0.50 ≤ 1.5	3 ≤ 0.25 ≤ 1.5	102	RPM	81189	43301	21650	10825
Fz	0.0008	0.0015	0.0031			0.007							0.019	0.040	0.048	0.064	0.070
Feed (mm/min)	130	130	134	152	206	260							260	208	182		
	195	195	201	227	309	390							390	312	273		
	260	260	268	303	411	520							520	416	364		
Slot	2 1 ≤ 1	3 1 ≤ 0.5	4 1 ≤ 0.4	75	RPM	59377							31668	15834	7917	3958	2375
					Fz	0.0008			0.0015	0.0031	0.007	0.019	0.040	0.048	0.064	0.070	
					Feed (mm/min)	95			95	98	111	150	190	190	152	133	
						143			143	147	166	226	285	285	228	200	
						190			190	196	222	301	380	380	304	266	
					STAINLESS STEELS (FREE MACHINING) 303, 416, 420F, 430F 440F	≤ 275 Bhn or ≤ 28 HRC			Profile	2 ≤ 0.50 ≤ 1.5	3 ≤ 0.25 ≤ 1.5	113	RPM	89671	47825	23912	11956
Fz	0.0005	0.0012	0.0022	0.006									0.014	0.029	0.036	0.048	0.052
Feed (mm/min)	90	115	105	143			167	208					215	172	149		
	135	172	158	215			251	312					323	258	224		
	179	230	210	287			335	416					430	344	298		
Slot	2 1 ≤ 1	3 1 ≤ 0.5	4 1 ≤ 0.4	82			RPM	65436					34899	17449	8725	4362	2617
							Fz	0.0005	0.0012	0.0022	0.006	0.014	0.029	0.036	0.048	0.052	
							Feed (mm/min)	65	84	77	105	122	152	157	126	109	
								98	126	115	157	183	228	236	188	163	
								131	168	154	209	244	304	314	251	218	
							STAINLESS STEELS (DIFFICULT) 304, 304L, 316, 316L, 17-4 PH, 15-5, 13-4, Custom 450	≤ 275 Bhn or ≤ 28 HRC	Profile	2 ≤ 0.50 ≤ 1.5	3 ≤ 0.25 ≤ 1.5	78	RPM	61800	32960	16480	8240
Fz	0.0005	0.0010	0.0019	0.004									0.012	0.024	0.029	0.037	0.042
Feed (mm/min)	62	66	63	66	99	119							119	91	83		
	93	99	94	99	148	178							179	137	125		
	124	132	125	132	198	237							239	183	166		
Slot	2 1 ≤ 1	3 1 ≤ 0.5	4 1 ≤ 0.4	56	RPM	44836							23912	11956	5978	2989	1793
					Fz	0.0005			0.0010	0.0019	0.004	0.012	0.024	0.029	0.037	0.042	
					Feed (mm/min)	45			48	45	48	72	86	87	66	60	
						67			72	68	72	108	129	130	100	90	
						90			96	91	96	143	172	173	133	121	

continued on next page

2 Flute: Square, Double, Stub, Long Reach, Ball 3 Flute: Square, Long Reach, Ball 4 Flute: Square, Double, Stub, Long Reach, Ball, Corner Radius

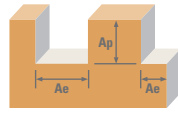

Series
1M, 3M, 5M,
14M, 15M, 16M,
17M, 59M
Metric

Diameter (D₁)
(mm)

Series	Hardness	Flutes	Ae x D ₁	Ap x D ₁	Vc (m/min)	Diameter (D ₁) (mm)											
						0.4	0.75	1.5	3	6	10	12	20	25			
SUPER ALLOYS (NICKEL, COBALT, IRON BASE) Inconel 601, 617, 625, 718, Incoloy 800, Monel 400, Rene, Waspalloy	≤ 300 Bhn or ≤ 32 HRc	Profile	2 ≤ 0.50 ≤ 1.5	3 ≤ 0.25 ≤ 1.5	20	RPM	15753	8402	4201	2100	1050	630	525	315	252		
						Fz	0.0005	0.0007	0.0014	0.004	0.010	0.021	0.024	0.032	0.035		
						Feed (mm/min)	16	12	12	17	21	26	25	20	18		
							24	18	18	25	32	40	38	30	26		
							32	24	24	34	42	53	50	40	35		
						Slot	2 1 ≤ 1	3 1 ≤ 0.5	4 1 ≤ 0.4	14	RPM	10906	5816	2908	1454	727	436
		Fz	0.0005	0.0007	0.0014						0.004	0.010	0.021	0.024	0.032	0.035	
		Feed (mm/min)	11	8	8						12	15	18	17	14	12	
			16	12	12						17	22	27	26	21	18	
			22	16	16						23	29	37	35	28	24	
		TITANIUM ALLOYS Ti6Al4V, Ti6Al2Sn4Zr2Mo, Ti4Al4Mo2Sn0.5Si, Ti10Al2Fe3Al, Ti5Al3Mo3Cr, Ti7Al4Mo, Ti3Al8V6Cr4Zr4Mo, Ti6Al6V6Sn, Ti152 Cr3Sn3Al	≤ 350 Bhn or ≤ 38 HRc	Profile	2 ≤ 0.50 ≤ 1.5						3 ≤ 0.25 ≤ 1.5	55	RPM	43624	23266	11633	5816
						Fz	0.0005	0.0010	0.0019	0.004			0.012	0.024	0.029	0.037	0.042
Feed (mm/min)	44					47	44	47	70	84			84	65	59		
	65					70	66	70	105	126			127	97	88		
	87					93	88	93	140	168			169	129	117		
Slot	2 1 ≤ 1					3 1 ≤ 0.5	4 1 ≤ 0.4	40	RPM	31506			16803	8402	4201	2100	1260
				Fz	0.0005				0.0010	0.0019	0.004	0.012	0.024	0.029	0.037	0.042	
				Feed (mm/min)	32				34	32	34	50	60	61	47	42	
					47				50	48	50	76	91	91	70	64	
					63				67	64	67	101	121	122	93	85	
				ALUMINUM ALLOYS 2017, 2024, 356, 6061, 7075	≤ 150 Bhn or ≤ 7 HRc				Profile	2 ≤ 0.50 ≤ 1.5	3 ≤ 0.25 ≤ 1.5	268	RPM	213272	113745	56872	28436
Fz	0.0015					0.0032	0.0060	0.014					0.038	0.080	0.096	0.128	0.140
Feed (mm/min)	640	728	682			796	1081	1365					1365	1092	955		
	960	1092	1024			1194	1621	2047					2047	1638	1433		
	1280	1456	1365			1592	2161	2730					2730	2184	1911		
Slot	2 1 ≤ 1	3 1 ≤ 0.5	4 1 ≤ 0.4			195	RPM	155107					82724	41362	20681	10340	6204
							Fz	0.0015	0.0032	0.0060	0.014	0.038	0.080	0.096	0.128	0.140	
							Feed (mm/min)	465	529	496	579	786	993	993	794	695	
								698	794	745	869	1179	1489	1489	1191	1042	
								931	1059	993	1158	1572	1985	1985	1588	1390	
							COPPER ALLOYS Alum Bronze, C110, Muntz Brass	≤ 140 Bhn or ≤ 3 HRc	Profile	2 ≤ 0.50 ≤ 1.5	3 ≤ 0.25 ≤ 1.5	148	RPM	117542	62689	31344	15672
Fz	0.0008	0.0015	0.0031			0.007							0.019	0.040	0.048	0.064	0.070
Feed (mm/min)	188	188	194	219	298	376							376	301	263		
	282	282	292	329	447	564							564	451	395		
	376	376	389	439	596	752							752	602	527		
Slot	2 1 ≤ 1	3 1 ≤ 0.5	4 1 ≤ 0.4	195	RPM	84824							45239	22620	11310	5655	3393
					Fz	0.0008			0.0015	0.0031	0.007	0.019	0.040	0.048	0.064	0.070	
					Feed (mm/min)	136			136	140	158	215	271	271	217	190	
						204			204	210	238	322	407	407	326	285	
						271			271	280	317	430	543	543	434	380	
					PLASTICS Polycarbonate, PVC, Polypropylene				Profile	2 ≤ 0.50 ≤ 1.5	3 ≤ 0.25 ≤ 1.5	268	RPM	213272	113745	56872	28436
Fz	0.0015	0.0032	0.0060	0.014									0.038	0.080	0.096	0.128	0.140
Feed (mm/min)	640	728	682	796			1081	1365					1365	1092	955		
	960	1092	1024	1194			1621	2047					2047	1638	1433		
	1280	1456	1365	1592			2161	2730					2730	2184	1911		
Slot	2 1 ≤ 1	3 1 ≤ 0.5	4 1 ≤ 0.4	195			RPM	155107					82724	41362	20681	10340	6204
							Fz	0.0015	0.0032	0.0060	0.014	0.038	0.080	0.096	0.128	0.140	
							Feed (mm/min)	465	529	496	579	786	993	993	794	695	
								698	794	745	869	1179	1489	1489	1191	1042	
								931	1059	993	1158	1572	1985	1985	1588	1390	
							GRAPHITE		Profile	2 ≤ 0.50 ≤ 1.5	3 ≤ 0.25 ≤ 1.5	201	RPM	159954	85309	42654	21327
Fz	0.0015	0.0032	0.0060	0.014									0.038	0.080	0.096	0.128	0.140
Feed (mm/min)	480	546	512	597	810	1024							1024	819	717		
	720	819	768	896	1216	1536							1536	1228	1075		
	960	1092	1024	1194	1621	2047							2047	1638	1433		
Slot	2 1 ≤ 1	3 1 ≤ 0.5	4 1 ≤ 0.4	146	RPM	116330							62043	31021	15511	7755	4653
					Fz	0.0015			0.0032	0.0060	0.014	0.038	0.080	0.096	0.128	0.140	
					Feed (mm/min)	349			397	372	434	589	745	745	596	521	
						523			596	558	651	884	1117	1117	893	782	
						698			794	745	869	1179	1489	1489	1191	1042	

Bhn (Brinell) HRc (Rockwell C)
rpm = (Vc x 1000) / (D₁ x 3.14)
mm/min = Fz x number of flutes x rpm
reduce speed and feed for materials harder than listed

limit cut depths of long and extra long flute mills to .05 x D₁ when slotting or profiling
reduce feed and Ae when finish milling (.02 x D₁ maximum)
refer to the KYOCERA SGS Tool Wizard® for complete technical information
(www.kyocera-sgstool.com)

METRIC

Single End Roughers (Fine Pitch)

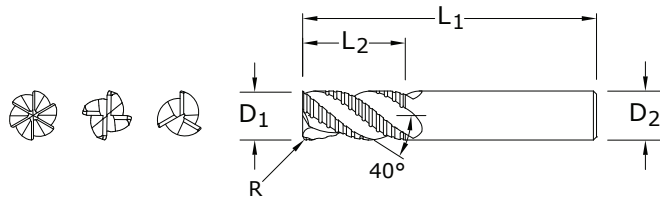

62M
METRIC SERIES

TOLERANCES h10 (mm)

$D_1 = +0,000 / -0,100$

$D_2 = h_6$

$R = +0,127 / -0,127$

CUTTING DIAMETER D_1	LENGTH OF CUT L_2	mm				NO. OF FLUTES	EDP NO.		
		OVERALL LENGTH L_1	SHANK DIAMETER D_2	CORNER RADIUS R	Ti-NAMITE (TiN)		Ti-NAMITE-C (TiCN)	Ti-NAMITE-A (AlTiN)	
6,0	19,0	63,0	6,0	1,14	3	46207	46206	46210	
8,0	19,0	63,0	8,0	1,14	3	46209	46208	46211	
10,0	22,0	72,0	10,0	1,52	3	46213	46212	46214	
12,0	26,0	83,0	12,0	1,52	4	46217	46216	46218	
16,0	32,0	92,0	16,0	1,52	4	46221	46220	46222	
20,0	38,0	104,0	20,0	1,52	4	46229	46228	46232	
25,0	44,0	104,0	25,0	1,52	6	46231	46230	46233	

STAINLESS STEELS





HIGH TEMP ALLOYS

TITANIUM

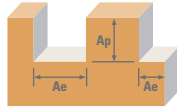
For patent information visit www.ksptpatents.com

Single End Roughers (Fine Pitch)



Series 62M Metric	Hardness	Ae x D ₁	Ap x D ₁	Vc (m/min)	Diameter (D ₁) (mm)								
					6	10	12	20	25				
M	STAINLESS STEELS (FREE MACHINING) 303, 416, 420F, 430F, 440F	≤ 275 Bhn or ≤ 28 HRc	Profile 	≤ 0.5 ≤ 1.5	123	RPM	6544	3926	3272	1963	1570		
					(99-148)	Fz	0.014	0.029	0.036	0.051	0.053		
						Feed (mm/min)	283	345	471	398	495		
					99	RPM	5251	3151	2626	1575	1260		
					(79-119)	Fz	0.014	0.029	0.036	0.051	0.053		
						Feed (mm/min)	227	277	378	319	397		
			STAINLESS STEELS (DIFFICULT) 304, 304L, 316, 316L, 17-4PH, 15-5PH, 13-4PH, Custom 450	≤ 275 Bhn or ≤ 28 HRc	Slot 	1 ≤ 1	85	RPM	4524	2714	2262	1357	1086
							(68-102)	Fz	0.012	0.024	0.029	0.040	0.043
								Feed (mm/min)	163	195	261	217	277
							69	RPM	3635	2181	1818	1091	872
(55-82)	Fz	0.012					0.024	0.029	0.040	0.043			
	Feed (mm/min)	131					157	209	174	222			
S	SUPER ALLOYS (NICKEL, COBALT, IRON BASE) Inconel 601, 617, 625, Incoloy 800, Monel 400, Rene, Waspalloy	≤ 300 Bhn or ≤ 32 HRc	Profile 	≤ 0.5 ≤ 1.5	21	RPM	1131	679	565	339	271		
					(17-26)	Fz	0.010	0.021	0.024	0.035	0.035		
						Feed (mm/min)	33	43	54	47	57		
					17	RPM	905	543	452	271	217		
					(14-20)	Fz	0.010	0.021	0.024	0.035	0.035		
						Feed (mm/min)	26	35	43	38	46		
			TITANIUM ALLOYS Ti6Al4V, Ti6Al2Sn4Zr2Mo, Ti4Al4Mo2Sn0.5Si, Ti10Al2Fe3Al, Ti5Al3Mo3Cr, Ti7Al4Mo, Ti3Al8V6Cr4Zr4Mo, Ti6Al6V6Sn, Ti152 Cr3Sn3Al	≤ 350 Bhn or ≤ 38 HRc	Slot 	1 ≤ 1	47	RPM	2504	1503	1252	751	601
							(38-57)	Fz	0.012	0.024	0.029	0.040	0.043
								Feed (mm/min)	90	108	144	120	153
							59	RPM	3151	1890	1575	945	756
(48-71)	Fz	0.012					0.024	0.029	0.040	0.043			
	Feed (mm/min)	113					136	181	151	193			

Bhn (Brinell) HRc (Rockwell C)
 rpm = (Vc x 1000) / (D₁ x 3.14)
 mm/min = Fz x number of flutes x rpm
 reduce speed and feed for materials harder than listed
 refer to the KYOCERA SGS Tool Wizard® for complete technical information (www.kyocera-sgstool.com)

METRIC

Single End Roughers (Coarse Pitch)

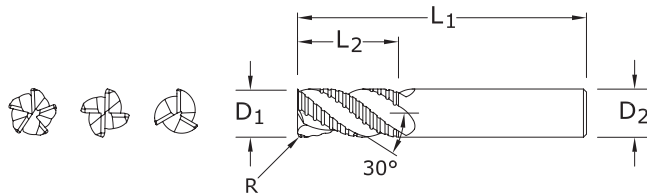

61M
METRIC SERIES

TOLERANCES h10 (mm)

$D_1 = +0,000 / -0,100$

$D_2 = h_6$

$R = +0,127 / -0,127$







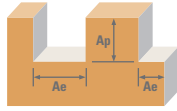

mm						EDP NO.		
CUTTING DIAMETER D_1	LENGTH OF CUT L_2	OVERALL LENGTH L_1	SHANK DIAMETER D_2	CORNER RADIUS R	NO. OF FLUTES	Ti-NAMITE (TiN)	Ti-NAMITE-C (TiCN)	Ti-NAMITE-A (AlTiN)
6,0	19,0	63,0	6,0	1,14	3	46107	46106	46110
8,0	19,0	63,0	8,0	1,14	3	46109	46108	46111
10,0	22,0	72,0	10,0	1,52	3	46113	46112	46114
12,0	26,0	83,0	12,0	1,52	4	46117	46116	46118
16,0	32,0	92,0	16,0	1,52	4	46121	46120	46122
20,0	38,0	104,0	20,0	1,52	4	46129	46128	46132
25,0	44,0	104,0	25,0	1,52	5	46131	46130	46133

- STEELS
- CAST IRON
- HARDENED STEELS

For patent information visit
www.ksptpatents.com

Single End Roughers (Coarse Pitch)



Series 61M Metric	Hardness	Ae x D ₁	Ap x D ₁	Vc (m/min)	Diameter (D ₁) (mm)							
					6	10	12	20	25			
P	CARBON STEELS 1018, 1040, 1080, 1090, 10L50, 1140, 1212, 12L15, 1525, 1536	≤ 175 Bhn or ≤ 7 HRc	Profile 	≤ 0.5	≤ 1.5	152	RPM	8078	4847	4039	2424	1939
						(122-183)	Fz	0.014	0.029	0.034	0.045	0.050
						Feed (mm/min)	339	422	549	436	485	
			Slot 	1	≤ 1	122	RPM	6463	3878	3231	1939	1551
						(98-146)	Fz	0.014	0.029	0.034	0.045	0.050
						Feed (mm/min)	271	337	439	349	388	
	ALLOY STEELS 4140, 4150, 4320, 5120, 5150, 8630, 86L20, 50100	≤ 275 Bhn or ≤ 28 HR	Profile 	≤ 0.5	≤ 1.5	111	RPM	5897	3538	2949	1769	1415
						(89-134)	Fz	0.010	0.021	0.026	0.035	0.038
						Feed (mm/min)	177	223	307	248	269	
			Slot 	1	≤ 1	90	RPM	4766	2860	2383	1430	1144
						(72-108)	Fz	0.010	0.021	0.026	0.035	0.038
						Feed (mm/min)	143	180	248	200	217	
H	≤ 250 Bhn or ≤ 24 HRc	Profile 	≤ 0.5	≤ 1.5	105	RPM	5574	3344	2787	1672	1338	
					(84-126)	Fz	0.014	0.024	0.036	0.048	0.053	
					Feed (mm/min)	234	241	401	321	355		
		Slot 	1	≤ 1	84	RPM	4443	2666	2222	1333	1066	
					(67-101)	Fz	0.014	0.024	0.036	0.048	0.053	
					Feed (mm/min)	187	192	320	256	283		
K	≤ 220 Bhn or ≤ 19 HRc	Profile 	≤ 0.5	≤ 1.5	111	RPM	5897	3538	2949	1769	1415	
					(89-134)	Fz	0.019	0.040	0.048	0.064	0.070	
					Feed (mm/min)	336	425	566	453	495		
		Slot 	1	≤ 1	90	RPM	4766	2860	2383	1430	1144	
					(72-108)	Fz	0.019	0.040	0.048	0.064	0.070	
					Feed (mm/min)	272	343	458	366	400		

Bhn (Brinell) HRc (Rockwell C)
 rpm = (Vc x 1000) / (D₁ x 3.14)
 mm/min = Fz x number of flutes x rpm
 reduce speed and feed for materials harder than listed
 refer to the KYOCERA SGS Tool Wizard® for complete technical information (www.kyocera-sgstool.com)

METRIC

2 Flute High Shear End Mills

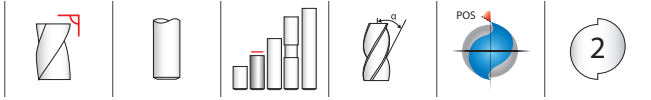

52M
METRIC SERIES

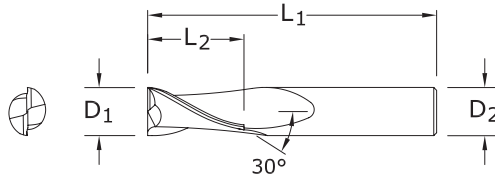

TOLERANCES (mm)

$D_1 = +0,000/-0,050$

$D_2 = h_6$

CUTTING DIAMETER D_1	LENGTH OF CUT L_2	OVERALL LENGTH L_1	SHANK DIAMETER D_2	EDP NO.	
				UNCOATED	Ti-NAMITE-C (TiCN)
3,0	7,0	38,0	3,0	45277	49829
3,5	7,0	57,0	6,0	45279	49830
4,0	8,0	57,0	6,0	45281	49831
4,5	8,0	57,0	6,0	45283	49832
5,0	10,0	57,0	6,0	45285	49833
6,0	10,0	57,0	6,0	45287	49834
8,0	16,0	63,0	8,0	45289	49835
10,0	19,0	72,0	10,0	45291	49836
12,0	22,0	83,0	12,0	45293	49837
14,0	22,0	83,0	14,0	45295	49838
16,0	26,0	92,0	16,0	45297	49839
20,0	32,0	104,0	20,0	45299	49840

NON-FERROUS

PLASTICS/COMPOSITES

For patent information visit www.ksptpatents.com

4 Flute High Shear End Mills



TOLERANCES (mm)

$D_1 = +0,000/-0,050$

$D_2 = h_6$

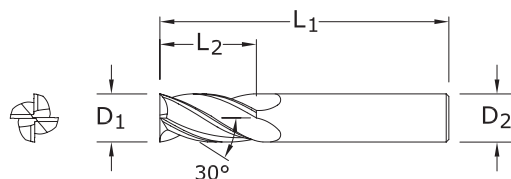

54M
METRIC SERIES

CUTTING DIAMETER D_1	LENGTH OF CUT L_2	OVERALL LENGTH L_1	SHANK DIAMETER D_2	EDP NO.	
				UNCOATED	Ti-NAMITE-C (TiCN)
3,0	8,0	38,0	3,0	45477	45478
3,5	10,0	57,0	6,0	45479	45480
4,0	11,0	57,0	6,0	45481	45482
4,5	11,0	57,0	6,0	45483	45484
5,0	13,0	57,0	6,0	45485	45486
6,0	13,0	57,0	6,0	45487	45488
8,0	19,0	63,0	8,0	45489	45490
10,0	22,0	72,0	10,0	45491	45492
12,0	26,0	83,0	12,0	45493	45494
14,0	26,0	83,0	14,0	45495	45496
16,0	32,0	92,0	16,0	45497	45498
20,0	38,0	104,0	20,0	45499	45500

- NON-FERROUS
- PLASTICS/COMPOSITES

For patent information visit www.ksptpatents.com

2 Flute: High Shear End Mills

4 Flute: High Shear End Mills

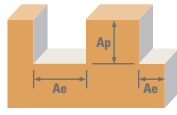





Series 52M, 54M Metric	Hardness	Flutes	Ae x D ₁	Ap x D ₁	V _c (m/min)	Diameter (D ₁) (mm)							
						3	6	10	12	20	25		
ALUMINUM ALLOYS 2024, 5052, 5086, 6061, 6063, 7075	≤ 150 Bhn or ≤ 7 HRc	Profile 	2	≤ 0.3	≤ 1.5	415	RPM	43947	21973	13184	10987	6592	5274
						(332-497)	Fz	0.0166	0.043	0.091	0.110	0.147	0.160
							Feed (mm/min)	1459	1890	2399	2417	1938	1688
		4	≤ 0.3	≤ 1.5	332	RPM	35222	17611	10567	8806	5283	4227	
					(266-399)	Fz	0.0151	0.041	0.085	0.101	0.133	0.148	
						Feed (mm/min)	1064	1444	1796	1779	1405	1251	
	Slot 	2	1	≤ 1	125	RPM	16480	8240	4944	4120	2472	1978	
						(100-150)	Fz	0.0166	0.043	0.091	0.110	0.147	0.160
							Feed (mm/min)	547	709	900	906	727	633
		4	1	≤ 0.25	125	RPM	13249	6624	3975	3312	1987	1590	
						(100-150)	Fz	0.0151	0.041	0.085	0.101	0.133	0.148
							Feed (mm/min)	400	543	676	669	529	471
ALUMINUM DIE CAST ALLOYS (HIGH SILICON) A-390, A-392, B-390	≤ 125 Bhn or ≤ 77 HRb	Profile 	2	≤ 0.3	≤ 1.5	155	RPM	16480	8240	4944	4120	2472	1978
						(124-187)	Fz	0.0166	0.043	0.091	0.110	0.147	0.160
							Feed (mm/min)	547	709	900	906	727	633
		4	≤ 0.3	≤ 1.5	125	RPM	13249	6624	3975	3312	1987	1590	
						(100-150)	Fz	0.0151	0.041	0.085	0.101	0.133	0.148
							Feed (mm/min)	400	543	676	669	529	471
	Slot 	2	1	≤ 1	180	RPM	19065	9533	5720	4766	2860	2288	
						(144-216)	Fz	0.0094	0.024	0.053	0.062	0.083	0.093
							Feed (mm/min)	358	458	606	591	475	426
		4	≤ 0.3	≤ 1.5	145	RPM	15349	7675	4605	3837	2302	1842	
						(116-174)	Fz	0.0086	0.024	0.048	0.058	0.077	0.085
							Feed (mm/min)	264	368	442	445	355	313
Slot 	2	1	≤ 1	72	RPM	7594	3797	2278	1898	1139	911		
					(57-86)	Fz	0.0094	0.024	0.053	0.062	0.083	0.093	
						Feed (mm/min)	143	182	241	235	189	169	
	4	≤ 0.3	≤ 1.5	58	RPM	6140	3070	1842	1535	921	737		
					(46-69)	Fz	0.0086	0.024	0.048	0.058	0.077	0.085	
						Feed (mm/min)	106	147	177	178	142	125	
Slot 	2	1	≤ 1	58	RPM	6140	3070	1842	1535	921	737		
					(46-69)	Fz	0.0086	0.024	0.048	0.058	0.077	0.085	
						Feed (mm/min)	106	147	177	178	142	125	
	4	1	≤ 0.25	58	RPM	6140	3070	1842	1535	921	737		
					(46-69)	Fz	0.0086	0.024	0.048	0.058	0.077	0.085	
						Feed (mm/min)	106	147	177	178	142	125	

continued on next page

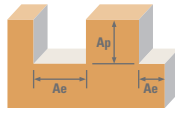
2 Flute: High Shear End Mills

4 Flute: High Shear End Mills



Series 52M, 54M Metric	Hardness	Flutes	Ae x D ₁	Ap x D ₁	Vc (m/min)	Diameter (D ₁) (mm)								
						3	6	10	12	20	25			
N	PLASTICS ABS, Polycarbonate, PVC, Polypropylene	Profile 			488	RPM	51702	25851	15511	12926	7755	6204		
					(390-585)	Fz	0.0264	0.072	0.149	0.178	0.237	0.250		
				2	≤ 0.3	≤ 1.5	Feed (mm/min)	2730	3723	4622	4601	3676	3102	
				4	≤ 0.3	≤ 1.5	Feed (mm/min)	5460	7445	9244	9203	7352	6204	
						390	RPM	41362	20681	12409	10340	6204	4963	
						(312-468)	Fz	0.0240	0.065	0.136	0.163	0.210	0.238	
			Slot 			390	RPM	41362	20681	12409	10340	6204	4963	
				2	1	≤ 1	Feed (mm/min)	1985	2689	3375	3371	2606	2363	
					4	1	≤ 0.25	Feed (mm/min)	3971	5377	6750	6742	5212	4725
			PLASTICS Fiberglass, Glass Filled			219	RPM	23266	11633	6980	5816	3490	2792	
				(176-263)	Fz	0.0197	0.053	0.109	0.132	0.173	0.190			
				2	≤ 0.3	≤ 1.5	Feed (mm/min)	917	1233	1522	1536	1208	1061	
				4	≤ 0.3	≤ 1.5	Feed (mm/min)	1833	2466	3043	3071	2415	2122	
				175	RPM	18580	9290	5574	4645	2787	2230			
				(140-210)	Fz	0.0180	0.048	0.101	0.120	0.160	0.175			
		Slot 			175	RPM	18580	9290	5574	4645	2787	2230		
			2	1	≤ 1	Feed (mm/min)	669	892	1126	1115	892	780		
				4	1	≤ 0.25	Feed (mm/min)	1338	1784	2252	2230	1784	1561	

Bhn (Brinell) HRc (Rockwell C) HRb (Rockwell B)

rpm = (Vc x 1000) / (D₁ x 3.14)

mm/min = Fz x number of flutes x rpm

reduce speed and feed for materials harder than listed

reduce feed and Ae when finish milling (.02 x D₁ maximum)

refer to the KYOCERA SGS Tool Wizard® for complete technical information (www.kyocera-sgstool.com)



High Performance Drills



Hole Making

HIGH PERFORMANCE DRILLS	SERIES	DESCRIPTION	PAGE
Hi-PerCarb	135 (3xD)	2 Flute External Coolant Double Margin 3xD	245
	135 (5xD)	2 Flute External Coolant Double Margin 5xD	254
	131N (3xD)	3 Flute External Coolant Triple Margin 3xD	264
	131N (5xD)	3 Flute External Coolant Triple Margin 5xD	268
	141K (5xD)	3 Flute Internal Coolant Triple Margin 5xD	274
Ice-Carb®	140 (5xD)	2 Flute Internal Coolant 5xD	280
	140 (8xD)	2 Flute Internal Coolant 8xD	288
CFRP 8 Facet	120	2 Flute External Coolant Double Margin CFRP	296

Speed & Feed Recommendations listed after each series

Taladrado

TALADROS DE ALTO RENDIMIENTO	SERIE	DESCRIPCIÓN	PÁGINA
Hi-PerCarb	135 (3xD)	2 filos, refrigerante externo, doble margen, 3xD	245
	135 (5xD)	2 filos, refrigerante externo, doble margen, 5xD	254
	131N (3xD)	3 filos, refrigerante externo, triple margen, 3xD	264
	131N (5xD)	3 filos, refrigerante externo, triple margen, 5xD	268
	141K (5xD)	3 filos, refrigerante interno, triple margen, 5xD	274
Ice-Carb®	140 (5xD)	2 filos, refrigerante interno, 5xD	280
	140 (8xD)	2 filos, refrigerante interno, 8xD	288
De 8 caras CFRP	120	2 filos, refrigerante externo, doble margen, CFRP	296

Recomendaciones de velocidades y avances mostradas tras cada serie

Outils de perçage

FORETS HAUTE PERFORMANCE	SÉRIES	DESCRIPTION	PAGE
Hi-PerCarb	135 (3xD)	2 dents refroidissement externe à double listel 3xD	245
	135 (5xD)	2 dents refroidissement externe à double listel 5xD	254
	131N (3xD)	3 dents refroidissement externe à triple listel 3xD	264
	131N (5xD)	3 dents refroidissement externe à triple listel 5xD	268
	141K (5xD)	3 dents refroidissement interne à triple listel 5xD	274
Ice-Carb®	140 (5xD)	2 dents refroidissement interne 5xD	280
	140 (8xD)	2 dents refroidissement interne 8xD	288
CFRP à 8 facettes	120	2 dents refroidissement externe à double listel CFRP	296

Recommandations de vitesse et avance indiquées après chaque série

Bohren

HOCHLEISTUNGS-BOHRER	SERIE	BESCHREIBUNG	SEITE
Hi-PerCarb	135 (3xD)	Doppelfasenbohrer 3xD mit 2 Schneidekanten und Außenkühlung	245
	135 (5xD)	Doppelfasenbohrer 5xD mit 2 Schneidekanten und Außenkühlung	254
	131N (3xD)	Dreifasenbohrer 3xD mit 3 Schneidekanten und Außenkühlung	264
	131N (5xD)	Dreifasenbohrer 5xD mit 3 Schneidekanten und Außenkühlung	268
	141K (5xD)	Dreifasenbohrer 5xD mit 3 Schneidekanten und Innenkühlung	274
Ice-Carb®	140 (5xD)	Bohrer 5xD mit 2 Schneidekanten und Innenkühlung	280
	140 (8xD)	Bohrer 8xD mit 2 Schneidekanten und Innenkühlung	288
CFRP 8 Facet	120	Doppelfasenbohrer CFRP mit 2 Schneidekanten und Außenkühlung	296

Empfehlungen für Drehzahl & Vorschub im Anhang zu jeder Serie

Drilling Operations Coolant Recommendations

- Coolant works to mobilize chips away from the cut zone, reduce the heat created during the cutting process and minimize friction.
- It is important to optimize the coolant pressure and position in order to gain the full benefits coolant offers the cutting process.
- Proper coolant application promotes greater operating parameters, greater material removal rates, improved surface finishes, predictable tool life, reduced power consumption and reduced cycle times.
- Pressure is important, but more importantly is consistency of the pressure and application onto the tool; intermittent cooling of carbide leads to thermal stressing of the material and the formation of “microcracks.”
- Proper cleanliness and filtration of coolants is important in order for the coolant to maintain its beneficial properties, and also to avoid a reduction in coolant pressure or the possibility of clogging the coolant channels in coolant through drills.

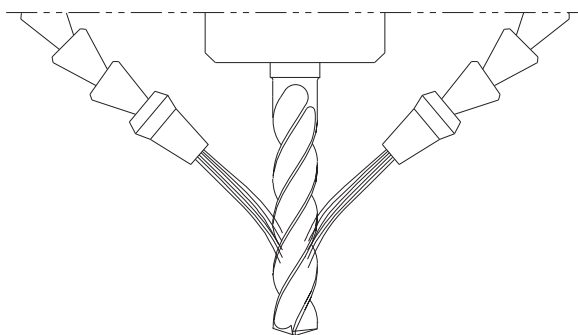
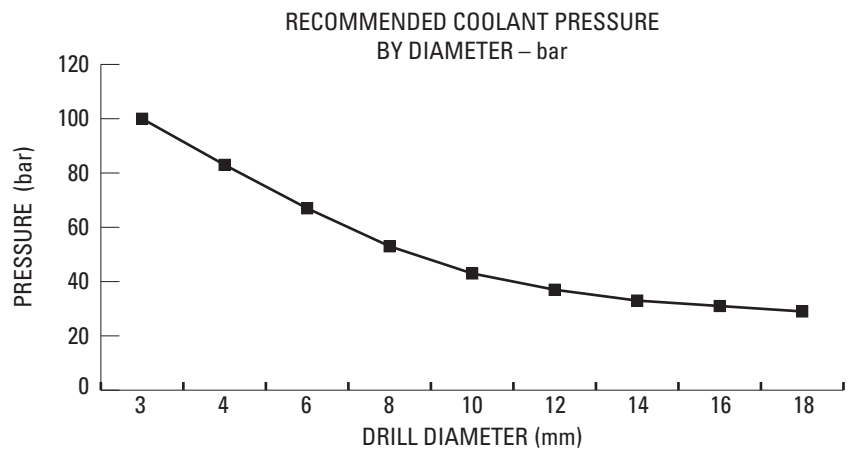
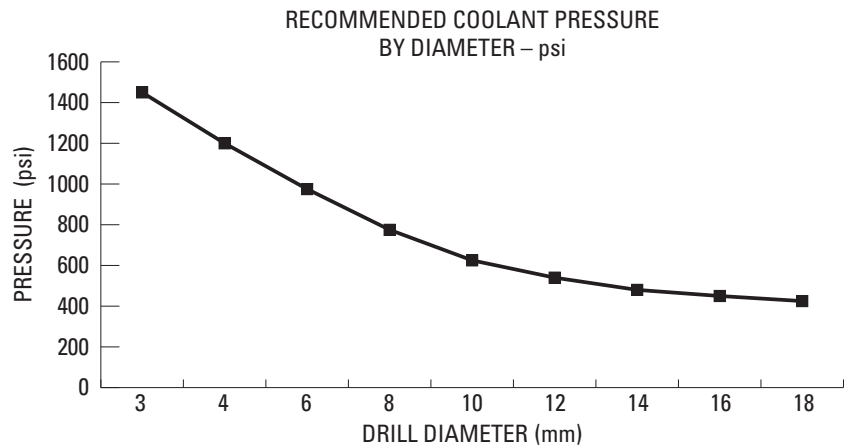

LARGE TIP – LOW VELOCITY
NO COVERAGE AT MAXIMUM DEPTH

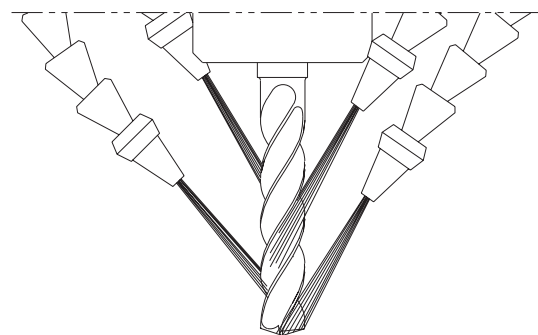

SMALL TIP – HIGH VELOCITY
COMPLETE COVERAGE

- Reducing the nozzle size helps maximize the cooling benefits of the unique double margin design on the Hi-PerCarb drill by increasing velocity. Aim the nozzles in line with the secondary flute located between the two margins as well as the flute for best results.

Operaciones de taladrado

Refrigerantes recomendados

- El líquido refrigerante actúa movilizandando las virutas fuera de la zona de corte, disminuyendo el calor generado durante el proceso de corte y minimizando la fricción.
- Es importante optimizar la presión del refrigerante y la posición para poder obtener todos los beneficios del refrigerante durante el proceso de corte.
- Una aplicación apropiada del refrigerante fomenta mayores parámetros de operación, mayores índices de eliminación de material, acabados de superficie mejorados, una duración de la herramienta más predecible, bajo consumo de energía y un tiempo de ciclo reducido.
- La presión es importante pero lo es más la estabilidad de la presión y la aplicación en la herramienta; la refrigeración intermitente del carburo conlleva un estrés térmico del material y la formación de "microfisuras".
- La limpieza adecuada y la filtración de refrigerantes es importante para que el mismo mantenga sus propiedades beneficiosas, y también para evitar una reducción en la presión o la posibilidad de obstruir los canales del refrigerante del taladro.

PRESIÓN DE REFRIGERANTE RECOMENDADA POR DIÁMETRO – psi

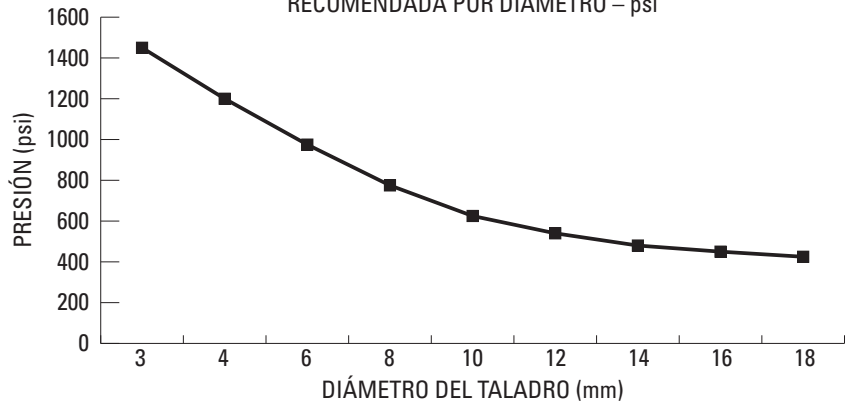

PRESIÓN DE REFRIGERANTE RECOMENDADA POR DIÁMETRO – bar

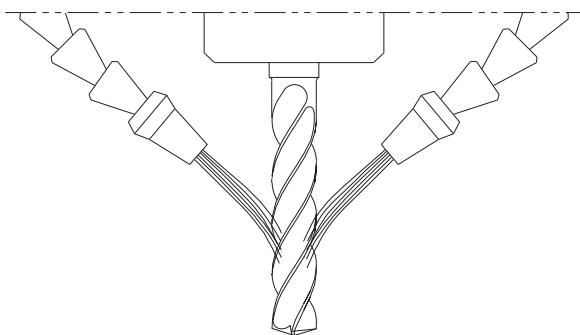
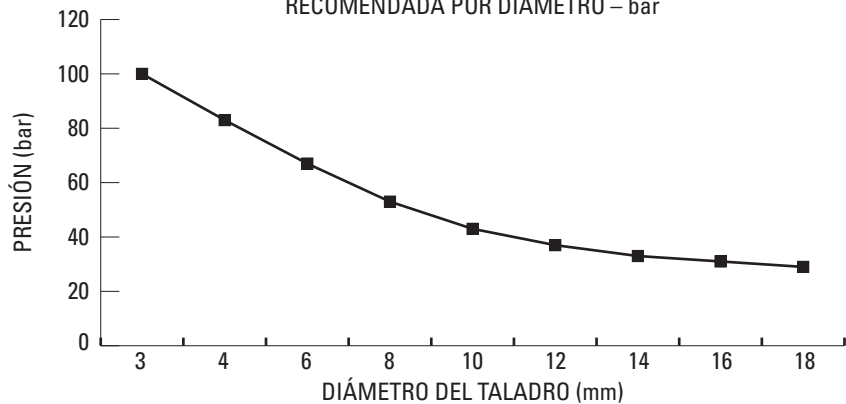

PUNTA GRANDE – BAJA VELOCIDAD
SIN ALCANCE A PROFUNDIDAD MÁXIMA

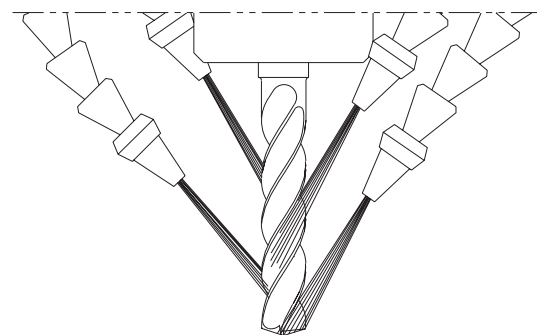

PUNTA PEQUEÑA – ALTA VELOCIDAD
COMPLETO ALCANCE

- Reducir el tamaño de la boquilla ayuda a maximizar los beneficios de refrigeración del exclusivo diseño de doble margen del taladro Hi-PerCarb aumentando la velocidad. Coloque las boquillas en línea con el segundo filo que se encuentra entre los dos márgenes y también el filo para obtener mejores resultados.

Opérations de forage

Recommandations en matière de refroidissement

- Le réfrigérant sert à éloigner les copeaux de la zone de coupe, à réduire la chaleur dégagée durant la coupe et à minimiser la friction.
- Il est important d'optimiser la pression et la position du réfrigérant pour en retirer les bénéfices maximums durant la coupe.
- L'application adéquate de réfrigérant se traduit par des paramètres opératoires supérieurs, des taux d'élimination supérieurs des matériaux, de plus belles finitions des surfaces, une durée de vie des outils prévisible, moins de consommation d'énergie et des temps de cycle réduits.
- La pression est importante, mais une pression régulière et l'application sur l'outil sont des facteurs encore plus importants ; le refroidissement intermittent du carbure se traduit par des contraintes thermiques pour le matériau et la formation de microfissures.
- La propreté et le filtrage adéquats des réfrigérants sont importants pour qu'ils conservent leur propriétés, mais aussi pour éviter la réduction de pression du réfrigérant ou le risque d'obturation des conduits à réfrigérant dans les perceuses à réfrigérant intégré.

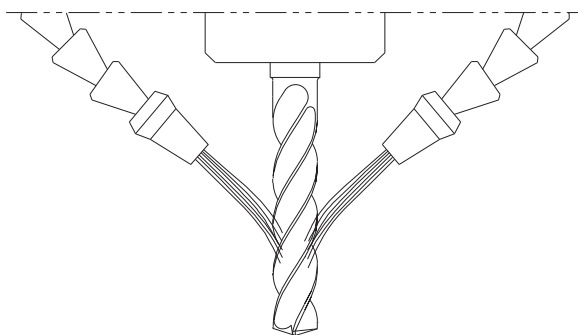
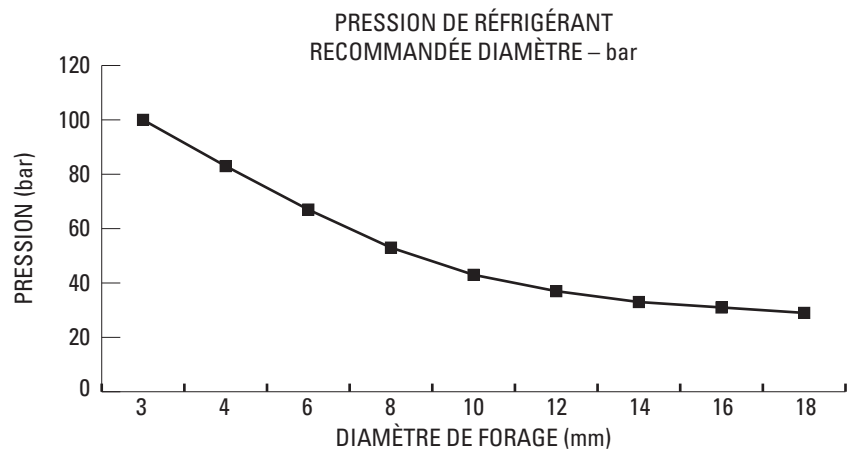
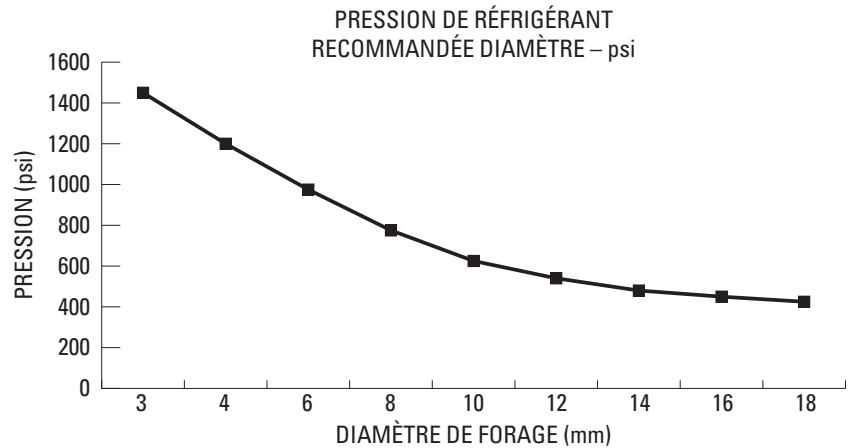

POINTE LARGE – BASSE VITESSE
PAS DE COUVERTURE À LA PROFONDEUR MAXIMUM

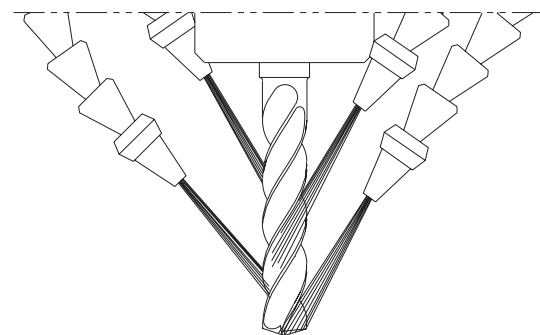

POINTE FINE – GRANDE VITESSE
COUVERTURE COMPLÈTE

- La réduction de la taille de l'embout permet de maximiser les bienfaits du refroidissement du concept à double listel original de la perceuse Hi-PerCarb en augmentant la vitesse. Pour les meilleurs résultats, orientez les embouts dans l'axe de la goujure secondaire située entre les deux listels, de même que la goujure primaire.

Bohrarbeiten

Kühlmittelempfehlungen

- Kühlmittel dienen dazu, die Späne aus dem Schneidenbereich zu entfernen, die beim Schneiden erzeugte Wärme abzutransportieren und die Reibung zu verringern.
- Es kommt darauf an, den Kühlschmiermitteldruck und die Zufuhr zu optimieren, um alle Vorteile beim Bohren nutzen zu können.
- Der richtige Kühlschmiermitteleinsatz ermöglicht höhere Schnittparameter, höheren Materialabtrag, geringere Oberflächenrauheit, vorhersehbare Standzeiten und geringere Leitungsaufnahme und Zykluszeiten.
- Der Druck ist wichtig, aber wichtiger ist dessen Konstanz und die Zufuhr zum Werkzeug. Unterbrochene Kühlung des Hartmetalls führt zur thermischen Belastung und Bildung von "Mikrorissen".
- Kühlmitteln sind sauber zu halten und zu filtern, damit die Qualität des Kühlmittels erhalten bleibt und der Kühlmitteldruck durch Verstopfung der Kühlmittelkanäle im Bohrer nicht absinkt.

EMPFOHLENER KÜHLSCHMIERMITTELDRUCK
NACH DURCHMESSER – psi

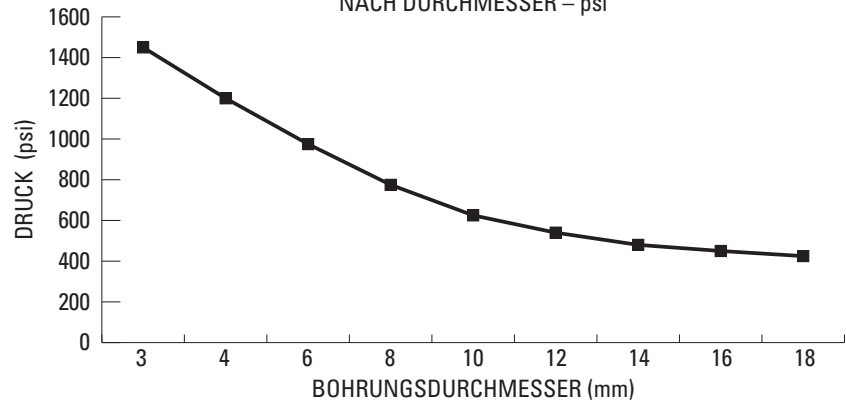

EMPFOHLENER KÜHLMITTELDRUCK
NACH DURCHMESSER – bar

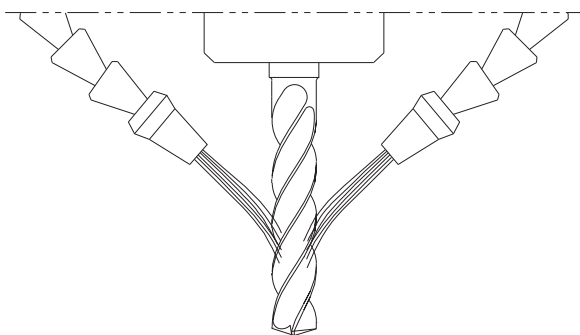
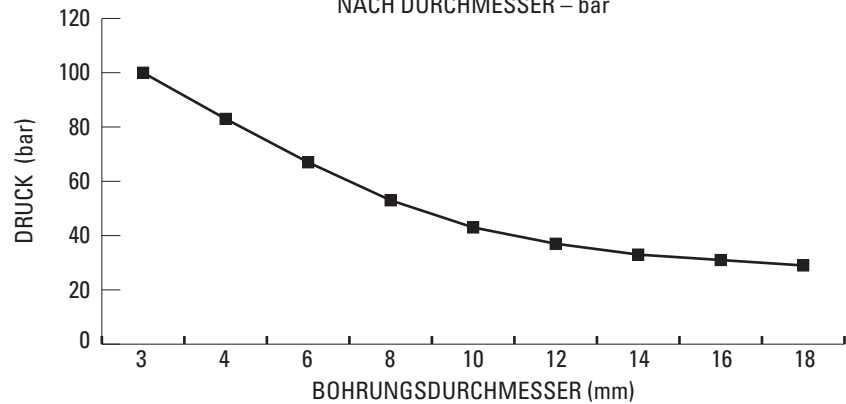

BREITE QUERSCHNEIDE – GERINGE DREHZAHL
KEINE VOLLSTÄNDIGE BENETZUNG BEI MAX. BOHRUNGSTIEFE

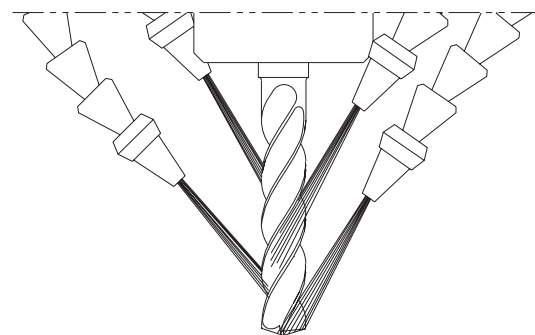

SCHMALE QUERSCHNEIDE – HOHE DREHZAHL
VOLLSTÄNDIGE BENETZUNG

- Durch Verringern der Düsengröße können die vorteilhaften Eigenschaften der Doppelfase genutzt werden, um die Drehzahl des Hi-PerCarb-Bohrers zu steigern. Richten Sie die Düsen auf die Nebennut zwischen beiden Fasen sowie auf die Schneidkante aus, um beste Ergebnisse zu erzielen.



3xD



2

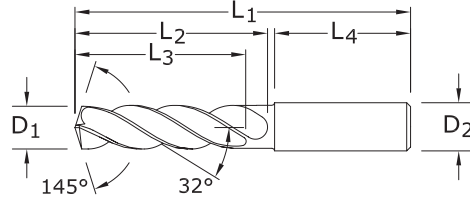

TOLERANCES (inch)

≤.1181 DIAMETER

D₁ = +.00008/+0.00047

D₂ = h₆

>.1181-.2362 DIAMETER

D₁ = +.00016/+0.00063

D₂ = h₆

>.2362-.3937 DIAMETER

D₁ = +.00024/+0.00083

D₂ = h₆

>.3937-.7087 DIAMETER

D₁ = +.00028/+0.00098

D₂ = h₆

>.7087-1.1811 DIAMETER

D₁ = +.00031/+0.00114

D₂ = h₆

TOLERANCES (mm)

≤3 DIAMETER

D₁ = +0,002/+0,012

D₂ = h₆

>3-6 DIAMETER

D₁ = +0,004/+0,016

D₂ = h₆

>6-10 DIAMETER

D₁ = +0,006/+0,021

D₂ = h₆

>10-18 DIAMETER

D₁ = +0,007/+0,025

D₂ = h₆

>18-30 DIAMETER

D₁ = +0,008/+0,029

D₂ = h₆

STEELS

STAINLESS STEELS

CAST IRON

HIGH TEMP ALLOYS

TITANIUM

NON-FERROUS

HARDENED STEELS

For patent information visit
www.ksptpatents.com

CUTTING DIAMETER	DECIMAL EQUIV.	METRIC EQUIV.	TAP SIZE REFERENCE ONLY	SHANK DIAMETER	OVERALL LENGTH	FLUTE LENGTH	CLEARED LENGTH	SHANK LENGTH	Ti-NAMITE-A (AITiN)	EDP NO.
D ₁				D ₂	L ₁	L ₂	L ₃	L ₄		
1/64	0.0156	0.40		1/8	1-1/2	1/8	5/64	1		51752*
1/32	0.0312	0.79		1/8	1-1/2	1/4	3/16	1		51269*
3/64	0.0469	1.19	1/16-64	1/8	1-1/2	3/8	5/16	1		51270*
1,25 mm	0.0492			3,0	38,0	9,5	8,0	25,0		64500*
1,45 mm	0.0571			3,0	38,0	9,5	8,0	25,0		64501*
#53	0.0595	1.51		1/8	1-1/2	3/8	5/16	1		64502*
1/16	0.0625	1.59	5/64-60	1/8	2	7/16	3/8	1-1/4		51271*
1,6 mm	0.0630			3,0	50,0	11,0	9,0	32,0		64503*
1,75 mm	0.0689			3,0	50,0	11,0	9,0	32,0		64504*
#50	0.0700	1.78		1/8	2	7/16	3/8	1-1/4		64505*
5/64	0.0781	1.98		1/8	2	1/2	7/16	1-1/4		51272*
#47	0.0785	1.99		1/8	2	1/2	7/16	1-1/4		64506*
2,05 mm	0.0807			3,0	50,0	12,0	11,0	32,0		64507*
#46	0.0810	2.06		1/8	2	1/2	7/16	1-1/4		64508*
#43	0.0890	2.26		1/8	2	1/2	7/16	1-1/4		64509*
#42	0.0935	2.37		1/8	2	1/2	7/16	1-1/4		64510*
3/32	0.0938	2.38	1/8-32	1/8	2	1/2	7/16	1-1/4		51273
#40	0.0980	2.49		1/8	2	9/16	1/2	1-1/4		51274
2,5 mm	0.0984			3,0	50,0	14,0	12,0	32,0		64511
#39	0.0995	2.53		1/8	2	9/16	1/2	1-1/4		51753
#38	0.1015	2.58	5-40	1/8	2	9/16	1/2	1-1/4		51754
#37	0.1040	2.64	5-44	1/8	2	9/16	1/2	1-1/4		51755
#36	0.1065	2.71	6-32	1/8	2	9/16	1/2	1-1/4		51756
7/64	0.1094	2.78		1/8	2	5/8	9/16	1-1/4		51275
#35	0.1100	2.79		1/8	2	5/8	9/16	1-1/4		51276
#34	0.1110	2.82		1/8	2	5/8	9/16	1-1/4		51277
#33	0.1130	2.87	6-40	1/8	2	5/8	9/16	1-1/4		51757
2,9 mm	0.1142			3,0	50,0	16,0	14,0	32,0		64512
#32	0.1160	2.95		1/8	2	5/8	9/16	1-1/4		51758
3,0 mm	0.1181			6,0	62,0	20,0	17,0	36,0		63155
#31	0.1200	3.05		1/8	2	5/8	9/16	1-1/4		51759
3,1 mm	0.1220			6,0	62,0	20,0	17,0	36,0		63741
1/8	0.1250	3.18		1/4	2-1/2	3/4	21/32	1-7/16		51330
3,2 mm	0.1260		M3,5 X 0,35	6,0	62,0	20,0	17,0	36,0		63156
#30	0.1285	3.26		1/4	2-1/2	3/4	21/32	1-7/16		51278
3,3 mm	0.1299		M4 X 0,7	6,0	62,0	20,0	17,0	36,0		63157
3,4 mm	0.1339			6,0	62,0	20,0	17,0	36,0		63158
#29	0.1360	3.45	8-32,8-36	1/4	2-1/2	3/4	21/32	1-7/16		51331
3,5 mm	0.1378		M4 X 0,5	6,0	62,0	20,0	17,0	36,0		63159
#28	0.1405	3.57	8-40	1/4	2-1/2	3/4	21/32	1-7/16		51760
9/64	0.1406	3.57		1/4	2-1/2	3/4	21/32	1-7/16		51332
3,6 mm	0.1417		M4 X 0,35	6,0	62,0	20,0	17,0	36,0		63160
#27	0.1440	3.66		1/4	2-1/2	3/4	21/32	1-7/16		51761
3,7 mm	0.1457		M4.5 X 0,75	6,0	62,0	20,0	17,0	36,0		63161
#26	0.1470	3.73	3/16-24	1/4	2-1/2	3/4	21/32	1-7/16		51762
#25	0.1495	3.80	10-24	1/4	2-5/8	7/8	23/32	1-7/16		51333

*Single Margin

continued on next page

135 3xD
FRACTIONAL & METRIC SERIES

- Double margin design improves accuracy and surface finish along with increased strength for aggressive drilling
- Specialized self-centering notched point eliminates the need for spot drilling decreasing thrust and deflection
- Engineered edge protection improves edge strength and reduces edge fatigue allowing for increased feed rates
- Recommended for materials ≤ 56 HRC (≤ 577 Bhn)

Hi-PerCarb



3xD



135 3xD

FRACTIONAL & METRIC SERIES

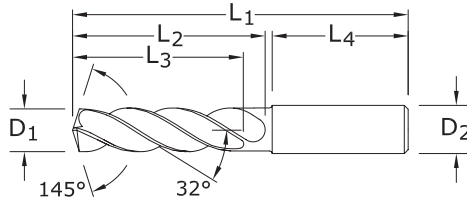

- Double margin design improves accuracy and surface finish along with increased strength for aggressive drilling
- Specialized self-centering notched point eliminates the need for spot drilling decreasing thrust and deflection
- Engineered edge protection improves edge strength and reduces edge fatigue allowing for increased feed rates
- Recommended for materials ≤ 56 HRc (≤ 577 Bhn)

CUTTING DIAMETER	DECIMAL EQUIV.	METRIC EQUIV.	TAP SIZE REFERENCE ONLY	SHANK DIAMETER	OVERALL LENGTH	FLUTE LENGTH	CLEARED LENGTH	SHANK LENGTH	Ti-NAMITE-A (AITiN)
D ₁				D ₂	L ₁	L ₂	L ₃	L ₄	EDP NO.
3,8 mm	0.1496			6,0	66,0	24,0	21,0	36,0	63742
#24	0.1520	3.86	10-28	1/4	2-5/8	7/8	23/32	1-7/16	51763
3,9 mm	0.1535			6,0	66,0	24,0	21,0	36,0	63743
#23	0.1540	3.91		1/4	2-5/8	7/8	23/32	1-7/16	51764
5/32	0.1562	3.97		1/4	2-5/8	7/8	23/32	1-7/16	51334
#22	0.1570	3.99	10-30	1/4	2-5/8	7/8	23/32	1-7/16	51765
4,0 mm	0.1575		M4,5 X 0,5	6,0	66,0	24,0	21,0	36,0	63162
#21	0.1590	4.04	10-32	1/4	2-5/8	7/8	23/32	1-7/16	51335
#20	0.1610	4.09	13/64-24	1/4	2-5/8	7/8	23/32	1-7/16	51279
4,1 mm	0.1614			6,0	66,0	24,0	21,0	36,0	63744
4,2 mm	0.1654		M5 / M5 X 0,75	6,0	66,0	24,0	21,0	36,0	63163
#19	0.1660	4.22		1/4	2-5/8	7/8	23/32	1-7/16	51766
4,3 mm	0.1693			6,0	66,0	24,0	21,0	36,0	63164
#18	0.1695	4.31		1/4	2-5/8	7/8	23/32	1-7/16	51767
11/64	0.1719	4.37		1/4	2-5/8	7/8	23/32	1-7/16	51336
#17	0.1730	4.39		1/4	2-5/8	7/8	23/32	1-7/16	51768
4,4 mm	0.1732			6,0	66,0	24,0	21,0	36,0	63745
#16	0.1770	4.50	12-24	1/4	2-5/8	7/8	23/32	1-7/16	51769
4,5 mm	0.1772		M5 X 0,5	6,0	66,0	24,0	21,0	36,0	63165
#15	0.1800	4.57		1/4	2-5/8	7/8	23/32	1-7/16	51770
4,6 mm	0.1811		12-28	6,0	66,0	24,0	21,0	36,0	63166
#14	0.1820	4.62		1/4	2-5/8	7/8	23/32	1-7/16	51771
#13	0.1850	4.70	12-32	1/4	2-5/8	7/8	23/32	1-7/16	51772
4,7 mm	0.1850			6,0	66,0	24,0	21,0	36,0	63746
3/16	0.1875	4.76		1/4	2-5/8	1	53/64	1-7/16	51337
#12	0.1890	4.80	7/32-32	1/4	2-5/8	1	53/64	1-7/16	51773
4,8 mm	0.1890			6,0	66,0	28,0	24,0	36,0	63167
#11	0.1910	4.85		1/4	2-5/8	1	53/64	1-7/16	51774
4,9 mm	0.1929			6,0	66,0	28,0	24,0	36,0	63747
#10	0.1935	4.91	14-20	1/4	2-5/8	1	53/64	1-7/16	51775
#9	0.1960	4.98		1/4	2-5/8	1	53/64	1-7/16	51776
5,0 mm	0.1969		M6 X 1	6,0	66,0	28,0	24,0	36,0	63168
#8	0.1990	5.05		1/4	2-5/8	1	53/64	1-7/16	51777
5,1 mm	0.2008			6,0	66,0	28,0	24,0	36,0	63748
#7	0.2010	5.11	1/4-20	1/4	2-5/8	1	53/64	1-7/16	51338
13/64	0.2031	5.16		1/4	2-5/8	1	53/64	1-7/16	51339
#6	0.2040	5.18		1/4	2-5/8	1	53/64	1-7/16	51778
5,2 mm	0.2047		M6 X 0,75	6,0	66,0	28,0	24,0	36,0	63749
#5	0.2055	5.22		1/4	2-5/8	1	53/64	1-7/16	51779
5,25 mm	0.2067			6,0	66,0	28,0	24,0	36,0	63169
5,3 mm	0.2087			6,0	66,0	28,0	24,0	36,0	63170
#4	0.2090	5.31	1/4-24	1/4	2-5/8	1	53/64	1-7/16	51780
5,4 mm	0.2126			6,0	66,0	28,0	24,0	36,0	63750
#3	0.2130	5.41	1/4-28	1/4	2-5/8	1	53/64	1-7/16	51340
5,5 mm	0.2165		M6 X 0,5	6,0	66,0	28,0	24,0	36,0	63171
7/32	0.2188	5.56	1/4-32	1/4	2-5/8	1	53/64	1-7/16	51341

TOLERANCES (inch)

$\leq .1181$ DIAMETER
 $D_1 = +.00008/+0.00047$
 $D_2 = h_6$

$>.1181-.2362$ DIAMETER
 $D_1 = +.00016/+0.00063$
 $D_2 = h_6$

$>.2362-.3937$ DIAMETER
 $D_1 = +.00024/+0.00083$
 $D_2 = h_6$

$>.3937-.7087$ DIAMETER
 $D_1 = +.00028/+0.00098$
 $D_2 = h_6$

$>.7087-1.1811$ DIAMETER
 $D_1 = +.00031/+0.0114$
 $D_2 = h_6$

TOLERANCES (mm)

≤ 3 DIAMETER
 $D_1 = +0,002/+0,012$
 $D_2 = h_6$

$>3-6$ DIAMETER
 $D_1 = +0,004/+0,016$
 $D_2 = h_6$

$>6-10$ DIAMETER
 $D_1 = +0,006/+0,021$
 $D_2 = h_6$

$>10-18$ DIAMETER
 $D_1 = +0,007/+0,025$
 $D_2 = h_6$

$>18-30$ DIAMETER
 $D_1 = +0,008/+0,029$
 $D_2 = h_6$

- STEELS
- STAINLESS STEELS
- CAST IRON
- HIGH TEMP ALLOYS
- TITANIUM
- NON-FERROUS
- HARDENED STEELS

For patent information visit www.ksptpatents.com

continued on next page



135 3xD

FRACTIONAL & METRIC SERIES

CUTTING DIAMETER	DECIMAL EQUIV.	METRIC EQUIV.	TAP SIZE REFERENCE ONLY	SHANK DIAMETER	OVERALL LENGTH	FLUTE LENGTH	CLEARED LENGTH	SHANK LENGTH	Ti-NAMITE-A (AITiN)
D ₁				D ₂	L ₁	L ₂	L ₃	L ₄	EDP NO.
5,6 mm	0.2205			6,0	66,0	28,0	24,0	36,0	63751
#2	0.2210	5.61		1/4	2-5/8	1	53/64	1-7/16	51781
5,7 mm	0.2244			6,0	66,0	28,0	24,0	36,0	63752
#1	0.2280	5.79		1/4	2-5/8	1	53/64	1-7/16	51782
5,8 mm	0.2283			6,0	66,0	28,0	24,0	36,0	63172
5,9 mm	0.2323			6,0	66,0	28,0	24,0	36,0	63753
A	0.2340	5.94		1/4	2-5/8	1	53/64	1-7/16	51601
15/64	0.2344	5.95		1/4	2-5/8	1	53/64	1-7/16	51342
6,0	0.2362	6.00	M7 X 1	6,0	66,0	28,0	24,0	36,0	63173
B	0.2380	6.05		1/4	3-1/8	1-5/16	1-3/64	1-7/16	51602
6,1 mm	0.2402			8,0	79,0	34,0	28,0	36,0	63754
C	0.2420	6.15		1/4	3-1/8	1-5/16	1-3/64	1-7/16	51603
6,2 mm	0.2441			8,0	79,0	34,0	28,0	36,0	63755
D	0.2460	6.25		1/4	3-1/8	1-5/16	1-3/64	1-7/16	51604
6,25 mm	0.2461		M7 X 0,75	8,0	79,0	34,0	28,0	36,0	63174
6,3 mm	0.2480			8,0	79,0	34,0	28,0	36,0	63756
1/4	0.2500	6.35		1/4	3-1/8	1-5/16	1-3/64	1-7/16	51343
E	0.2500	6.35		1/4	3-1/8	1-5/16	1-3/64	1-7/16	51605
6,4 mm	0.2520			8,0	79,0	34,0	28,0	36,0	63175
6,5 mm	0.2559			8,0	79,0	34,0	28,0	36,0	63213
F	0.2570	6.53	5/16-18	5/16	3-1/8	1-5/16	1-3/64	1-7/16	51344
6,6 mm	0.2598			8,0	79,0	34,0	28,0	36,0	63757
G	0.2610	6.63		5/16	3-1/8	1-5/16	1-3/64	1-7/16	51606
6,7 mm	0.2638			8,0	79,0	34,0	28,0	36,0	63758
17/64	0.2656	6.75	5/16-20	5/16	3-1/8	1-5/16	1-3/64	1-7/16	51345
H	0.2660	6.76		5/16	3-1/8	1-5/16	1-3/64	1-7/16	51607
6,8 mm	0.2677		M8 X 1,25	8,0	79,0	34,0	28,0	36,0	63176
6,9 mm	0.2717			8,0	79,0	34,0	28,0	36,0	63759
I	0.2720	6.91	5/16-24	5/16	3-1/8	1-5/16	1-3/64	1-7/16	51346
7,0 mm	0.2756		M8 X 1	8,0	79,0	34,0	28,0	36,0	63177
J	0.2770	7.04		5/16	3-1/8	1-5/16	1-3/64	1-7/16	51608
7,1 mm	0.2795			8,0	79,0	41,0	34,0	36,0	63760
K	0.2810	7.14		5/16	3-1/8	1-9/16	1-3/16	1-7/16	51609
9/32	0.2812	7.14	5/16-32	5/16	3-1/8	1-9/16	1-3/16	1-7/16	51347
7,2 mm	0.2835			8,0	79,0	41,0	34,0	36,0	63761
7,25 mm	0.2854		M8 X 0,75	8,0	79,0	41,0	34,0	36,0	63178
7,3 mm	0.2874			8,0	79,0	41,0	34,0	36,0	63762
L	0.2900	7.37		5/16	3-1/8	1-9/16	1-3/16	1-7/16	51610
7,4 mm	0.2913			8,0	79,0	41,0	34,0	36,0	63763
M	0.2950	7.49		5/16	3-1/8	1-9/16	1-3/16	1-7/16	51611
7,5 mm	0.2953		M8 X 0,5	8,0	79,0	41,0	34,0	36,0	63179
19/64	0.2969	7.54		5/16	3-1/8	1-9/16	1-3/16	1-7/16	51348
7,6 mm	0.2992			8,0	79,0	41,0	34,0	36,0	63764
N	0.3020	7.67		5/16	3-1/8	1-9/16	1-3/16	1-7/16	51612
7,7 mm	0.3031			8,0	79,0	41,0	34,0	36,0	63765
7,8 mm	0.3071		M9 X 1,25	8,0	79,0	41,0	34,0	36,0	63180
7,9 mm	0.3110			8,0	79,0	41,0	34,0	36,0	63766
5/16	0.3125	7.94	3/8-16	5/16	3-1/8	1-9/16	1-3/16	1-7/16	51349
8,0 mm	0.3150		M9 x 1	8,0	79,0	41,0	34,0	36,0	63181
O	0.3160	8.03		3/8	3-1/2	1-27/32	1-37/64	1-9/16	51613
8,1 mm	0.3189			10,0	89,0	47,0	40,0	40,0	63767
8,2 mm	0.3228			10,0	89,0	47,0	40,0	40,0	63768
P	0.3230	8.20		3/8	3-1/2	1-27/32	1-37/64	1-9/16	51614
8,3 mm	0.3268			10,0	89,0	47,0	40,0	40,0	63769
21/64	0.3281	8.33	3/8-20	3/8	3-1/2	1-27/32	1-37/64	1-9/16	51350
8,4 mm	0.3307			10,0	89,0	47,0	40,0	40,0	63182
Q	0.3320	8.43	3/8-24	3/8	3-1/2	1-27/32	1-37/64	1-9/16	51351
8,5 mm	0.3346		M10 X 1,5	10,0	89,0	47,0	40,0	40,0	63183

CONTINUED

continued on next page

Hi-PerCarb



3xD



135 3xD

FRACTIONAL & METRIC SERIES

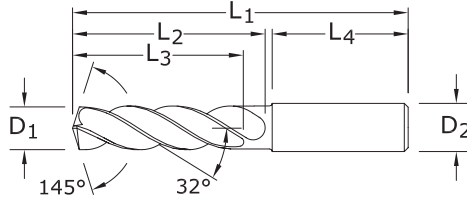

- Double margin design improves accuracy and surface finish along with increased strength for aggressive drilling
- Specialized self-centering notched point eliminates the need for spot drilling decreasing thrust and deflection
- Engineered edge protection improves edge strength and reduces edge fatigue allowing for increased feed rates
- Recommended for materials ≤ 56 HRc (≤ 577 Bhn)

CUTTING DIAMETER	DECIMAL EQUIV.	METRIC EQUIV.	TAP SIZE REFERENCE ONLY	SHANK DIAMETER	OVERALL LENGTH	FLUTE LENGTH	CLEARED LENGTH	SHANK LENGTH	Ti-NAMITE-A (AITiN)
D ₁				D ₂	L ₁	L ₂	L ₃	L ₄	EDP NO.
8,6 mm	0.3386			10,0	89,0	47,0	40,0	40,0	63770
R	0.3390	8.61		3/8	3-1/2	1-27/32	1-37/64	1-9/16	51615
8,7 mm	0.3425			10,0	89,0	47,0	40,0	40,0	63771
11/32	0.3438	8.73	3/8-32	3/8	3-1/2	1-27/32	1-37/64	1-9/16	51352
8,8 mm	0.3465		M10 X 1,25	10,0	89,0	47,0	40,0	40,0	63184
S	0.3480	8.84		3/8	3-1/2	1-27/32	1-37/64	1-9/16	51616
8,9 mm	0.3504			10,0	89,0	47,0	40,0	40,0	63772
9,0 mm	0.3543		M10 X 1	10,0	89,0	47,0	40,0	40,0	63185
T	0.3580	9.09		3/8	3-1/2	1-27/32	1-37/64	1-9/16	51617
9,1 mm	0.3583			10,0	89,0	47,0	40,0	40,0	63773
23/64	0.3594	9.13		3/8	3-1/2	1-27/32	1-37/64	1-9/16	51353
9,2 mm	0.3622		M10 X 0,75	10,0	89,0	47,0	40,0	40,0	63774
9,25 mm	0.3642	9.25		10,0	89,0	47,0	40,0	40,0	63186
9,3 mm	0.3661			10,0	89,0	47,0	40,0	40,0	63775
U	0.3680	9.35	7/16-14	3/8	3-1/2	1-27/32	1-37/64	1-9/16	51354
9,4 mm	0.3701			10,0	89,0	47,0	40,0	40,0	63776
9,5 mm	0.3740		M10 X 0,5	10,0	89,0	47,0	40,0	40,0	63187
3/8	0.3750	9.53		3/8	3-1/2	1-27/32	1-37/64	1-9/16	51355
V	0.3770	9.58		1/2	3-1/2	1-27/32	1-37/64	1-9/16	51618
9,6 mm	0.3780			10,0	89,0	47,0	40,0	40,0	63777
9,7 mm	0.3819			10,0	89,0	47,0	40,0	40,0	63778
9,8 mm	0.3858			10,0	89,0	47,0	40,0	40,0	63779
W	0.3860			1/2	3-1/2	1-27/32	1-37/64	1-9/16	51619
9,9 mm	0.3898			10,0	89,0	47,0	40,0	40,0	63780
25/64	0.3906	9.92	7/16-20	1/2	3-1/2	1-27/32	1-37/64	1-9/16	51356
10,0 mm	0.3937			10,0	89,0	47,0	40,0	40,0	63188
X	0.3970	10.08	7/16-24	1/2	4-1/16	2-3/16	1-51/64	1-49/64	51620
10,1 mm	0.3976			12,0	102,0	55,0	45,0	45,0	63781
10,2 mm	0.4016		M12 X 1,75	12,0	102,0	55,0	45,0	45,0	63189
Y	0.4040	10.26	7/16-28	1/2	4-1/16	2-3/16	1-51/64	1-49/64	51621
10,3 mm	0.4055			12,0	102,0	55,0	45,0	45,0	63782
13/32	0.4062	10.32		1/2	4-1/16	2-3/16	1-51/64	1-49/64	51357
10,4 mm	0.4094			12,0	102,0	55,0	45,0	45,0	63783
Z	0.4130	10.49		1/2	4-1/16	2-3/16	1-51/64	1-49/64	51622
10,5 mm	0.4134		M12 X 1,5	12,0	102,0	55,0	45,0	45,0	63190
10,6 mm	0.4173			12,0	102,0	55,0	45,0	45,0	63784
10,7 mm	0.4213			12,0	102,0	55,0	45,0	45,0	63785
27/64	0.4219	10.72	1/2-13	1/2	4-1/16	2-3/16	1-51/64	1-49/64	51358
10,8 mm	0.4252		M12 X 1,25	12,0	102,0	55,0	45,0	45,0	63191
10,9 mm	0.4291			12,0	102,0	55,0	45,0	45,0	63786
11,0 mm	0.4331		M12 X 1	12,0	102,0	55,0	45,0	45,0	63192
11,1 mm	0.4370			12,0	102,0	55,0	45,0	45,0	63787
7/16	0.4375	11.11	1/4-18 NPT	1/2	4-1/16	2-3/16	1-51/64	1-49/64	51359
11,2 mm	0.4409			12,0	102,0	55,0	45,0	45,0	63788
11,25 mm	0.4429			12,0	102,0	55,0	45,0	45,0	63193
11,3 mm	0.4449			12,0	102,0	55,0	45,0	45,0	63789
11,4 mm	0.4488			12,0	102,0	55,0	45,0	45,0	63790

TOLERANCES (inch)

- $\leq .1181$ DIAMETER
D₁ = +.0008/+0.0047
D₂ = h₆
- $>.1181-.2362$ DIAMETER
D₁ = +.00016/+0.00063
D₂ = h₆
- $>.2362-.3937$ DIAMETER
D₁ = +.00024/+0.00083
D₂ = h₆
- $>.3937-.7087$ DIAMETER
D₁ = +.00028/+0.00098
D₂ = h₆
- $>.7087-1.1811$ DIAMETER
D₁ = +.00031/+0.00114
D₂ = h₆

TOLERANCES (mm)

- ≤ 3 DIAMETER
D₁ = +0,002/+0,012
D₂ = h₆
- $>3-6$ DIAMETER
D₁ = +0,004/+0,016
D₂ = h₆
- $>6-10$ DIAMETER
D₁ = +0,006/+0,021
D₂ = h₆
- $>10-18$ DIAMETER
D₁ = +0,007/+0,025
D₂ = h₆
- $>18-30$ DIAMETER
D₁ = +0,008/+0,029
D₂ = h₆

- STEELS
- STAINLESS STEELS
- CAST IRON
- HIGH TEMP ALLOYS
- TITANIUM
- NON-FERROUS
- HARDENED STEELS

For patent information visit www.ksptpatents.com

continued on next page



135 3xD

FRACTIONAL & METRIC SERIES

CUTTING DIAMETER	DECIMAL EQUIV.	METRIC EQUIV.	TAP SIZE REFERENCE ONLY	SHANK DIAMETER	OVERALL LENGTH	FLUTE LENGTH	CLEARED LENGTH	SHANK LENGTH	Ti-NAMITE-A (AITIN)
D ₁				D ₂	L ₁	L ₂	L ₃	L ₄	EDP NO.
11,5 mm	0.4528		M12 X 0,5	12,0	102,0	55,0	45,0	45,0	63194
29/64	0.4531	11.51	1/2-20	1/2	4-1/16	2-3/16	1-51/64	1-49/64	51360
11,6 mm	0.4567			12,0	102,0	55,0	45,0	45,0	63791
11,7 mm	0.4606			12,0	102,0	55,0	45,0	45,0	63792
11,8 mm	0.4646			12,0	102,0	55,0	45,0	45,0	63793
11,9 mm	0.4685			12,0	102,0	55,0	45,0	45,0	63794
15/32	0.4688	11.91	1/2-28	1/2	4-1/16	2-3/16	1-51/64	1-49/64	51361
12,0 mm	0.4724		M14 X 2	12,0	102,0	55,0	45,0	45,0	63195
31/64	0.4844	12.30	9/16-12	1/2	4-1/4	2-5/16	1-7/8	1-49/64	51362
12,5 mm	0.4921		M14 X 1,5	14,0	107,0	60,0	49,0	45,0	63196
1/2	0.5000	12.70		1/2	4-1/4	2-5/16	1-7/8	1-49/64	51363
12,8 mm	0.5039		M14 X 1,25	14,0	107,0	60,0	49,0	45,0	63197
13,0 mm	0.5118		M14 X 1	14,0	107,0	60,0	49,0	45,0	63198
33/64	0.5156	13.10	9/16-18	5/8	4-1/4	2-5/16	1-7/8	1-49/64	51364
17/32	0.5312	13.49	5/8-11	5/8	4-1/4	2-5/16	1-7/8	1-49/64	51365
13,5 mm	0.5315			14,0	107,0	60,0	49,0	45,0	63199
35/64	0.5469	13.89	5/8-12	5/8	4-1/4	2-5/16	1-7/8	1-49/64	51783
14,0 mm	0.5512		M16 X 2	14,0	107,0	60,0	49,0	45,0	63200
9/16	0.5625	14.29		5/8	4-9/16	2-1/2	2	1-57/64	51366
14,5 mm	0.5709		M16 X 1,5	16,0	115,0	65,0	51,0	48,0	63201
37/64	0.5781	14.68	5/8-18	5/8	4-9/16	2-1/2	2	1-57/64	51367
15,0 mm	0.5906		M16 X 1	16,0	115,0	65,0	51,0	48,0	63202
19/32	0.5938	15.08	11/16-11	5/8	4-9/16	2-1/2	2	1-57/64	51784
39/64	0.6094	15.48	11/16-12	5/8	4-9/16	2-1/2	2	1-57/64	51785
15,5 mm	0.6102		M18 X 2,5	16,0	115,0	65,0	51,0	48,0	63203
5/8	0.6250	15.88	11/16-16	5/8	4-9/16	2-1/2	2	1-57/64	51368
16,0 mm	0.6299			16,0	115,0	65,0	51,0	48,0	63204
41/64	0.6406	16.27	11/16-24	3/4	4-7/8	2-3/4	2-5/16	1-57/64	51786
16,5 mm	0.6496		M18 X 1,5	18,0	123,0	73,0	58,0	48,0	63205
21/32	0.6562	16.67	3/4-10	3/4	4-7/8	2-3/4	2-5/16	1-57/64	51369
17,0 mm	0.6693			18,0	123,0	73,0	58,0	48,0	63206
43/64	0.6719	17.07	3/4-12	3/4	4-7/8	2-3/4	2-5/16	1-57/64	51787
11/16	0.6875	17.46	3/4-16	3/4	4-7/8	2-3/4	2-5/16	1-57/64	51370
17,5 mm	0.6890		M20 X 2,5	18,0	123,0	73,0	58,0	48,0	63207
45/64	0.7031	17.86	3/4-20, 1/2-14 NPT	3/4	4-7/8	2-3/4	2-5/16	1-57/64	51788
18,0 mm	0.7087			18,0	123,0	73,0	58,0	48,0	63208
23/32	0.7188	18.26		3/4	4-7/8	2-3/4	2-5/16	1-57/64	51789
18,5 mm	0.7283		M20 X 1,5	20,0	131,0	79,0	63,0	50,0	63209
47/64	0.7344	18.65	13/16-12	3/4	4-7/8	2-3/4	2-5/16	1-57/64	51790
19,0 mm	0.7480			20,0	131,0	79,0	63,0	50,0	63210
3/4	0.7500	19.05	13/16-16	3/4	5-1/4	3-1/16	2-7/16	1-31/32	51371
49/64	0.7656	19.45	7/8-9	7/8	5-1/4	3-1/16	2-7/16	1-31/32	51372
19,5 mm	0.7677		M22 X 2,5	20,0	131,0	79,0	63,0	50,0	63211
25/32	0.7812	19.84		7/8	6	3-11/16	2-11/16	2-1/8	51791
20,0 mm	0.7874			20,0	131,0	79,0	63,0	50,0	63212
51/64	0.7969	20.24	7/8-12	7/8	6	3-11/16	2-11/16	2-1/8	51792
20,5 mm	0.8071			22,0	150,0	93,0	73,0	53,0	64513
13/16	0.8125	20.64	7/8-14	7/8	6	3-11/16	2-11/16	2-1/8	51373
21,0 mm	0.8268			22,0	150,0	93,0	73,0	53,0	64514
22,0 mm	0.8661			22,0	150,0	93,0	73,0	53,0	64515
7/8	0.8750	22.23	15/16-16, 1-8	7/8	6	3-11/16	2-11/16	2-1/8	51374
59/64	0.9219	23.42	1-12	1	6	3-11/16	2-11/16	2-1/8	51375

CONTINUED

FRACTIONAL Hi-PerCarb

Series 135 3D Fractional	Hardness	Vc (sfm)	Diameter (D ₁) (inch)								
			1/32	1/8	1/4	3/8	1/2	5/8	7/8		
P CARBON STEELS 1018, 1040, 1080, 1090, 10L50, 1140, 1212, 12L15, 1525, 1536	≤ 175 Bhn or ≤ 7 HRc	385	RPM	47062	11766	5883	3922	2941	2353	1681	
		(308-462)	Fr	0.0010	0.0038	0.0076	0.0115	0.0153	0.0191	0.0268	
			Feed (ipm)	45.0	45.0	45.0	45.0	45.0	45.0	45.0	
	≤ 275 Bhn or ≤ 28 HRc	350	RPM	42784	10696	5348	3565	2674	2139	1528	
		(280-420)	Fr	0.0009	0.0036	0.0071	0.0107	0.0142	0.0178	0.0249	
			Feed (ipm)	38.0	38.0	38.0	38.0	38.0	38.0	38.0	
	≤ 425 Bhn or ≤ 45 HRc	200	RPM	24448	6112	3056	2037	1528	1222	873	
		(160-240)	Fr	0.0007	0.0029	0.0059	0.0088	0.0118	0.0147	0.0206	
			Feed (ipm)	18.0	18.0	18.0	18.0	18.0	18.0	18.0	
	H ALLOY STEELS 4140, 4150, 4320, 5120, 5150, 8630, 86L20, 50100	≤ 275 Bhn or ≤ 28 HRc	300	RPM	36672	9168	4584	3056	2292	1834	1310
			(240-360)	Fr	0.0007	0.0029	0.0059	0.0088	0.0118	0.0147	0.0206
				Feed (ipm)	27.0	27.0	27.0	27.0	27.0	27.0	27.0
≤ 375 Bhn or ≤ 40 HRc		185	RPM	22614	5654	2827	1885	1413	1131	808	
		(148-222)	Fr	0.0006	0.0026	0.0051	0.0077	0.0103	0.0128	0.0180	
			Feed (ipm)	14.5	14.5	14.5	14.5	14.5	14.5	14.5	
≤ 450 Bhn or ≤ 48 HRc		130	RPM	15891	3973	1986	1324	993	795	568	
		(104-156)	Fr	0.0004	0.0018	0.0035	0.0053	0.0070	0.0088	0.0123	
			Feed (ipm)	7.0	7.0	7.0	7.0	7.0	7.0	7.0	
K TOOL STEELS A2, D2, H13, L2, M2, P20, S7, T15, W2		≤ 200 Bhn or ≤ 13 HRc	130	RPM	15891	3973	1986	1324	993	795	568
			(104-156)	Fr	0.0007	0.0026	0.0053	0.0079	0.0106	0.0132	0.0185
				Feed (ipm)	10.5	10.5	10.5	10.5	10.5	10.5	10.5
	≤ 375 Bhn or ≤ 40 HRc	90	RPM	11002	2750	1375	917	688	550	393	
		(72-108)	Fr	0.0003	0.0012	0.0023	0.0035	0.0047	0.0058	0.0081	
			Feed (ipm)	3.2	3.2	3.2	3.2	3.2	3.2	3.2	
	≤ 475 Bhn or ≤ 50 HRc	75	RPM	9168	2292	1146	764	573	458	327	
		(60-90)	Fr	0.0002	0.0008	0.0016	0.0024	0.0031	0.0039	0.0055	
			Feed (ipm)	1.8	1.8	1.8	1.8	1.8	1.8	1.8	
	M CAST IRONS Gray, Malleable, Ductile	≤ 220 Bhn or ≤ 19 HRc	320	RPM	39117	9779	4890	3260	2445	1956	1397
			(256-384)	Fr	0.0012	0.0046	0.0092	0.0138	0.0184	0.0230	0.0322
				Feed (ipm)	45.0	45.0	45.0	45.0	45.0	45.0	45.0
≤ 260 Bhn or ≤ 26 HRc		285	RPM	34838	8710	4355	2903	2177	1742	1244	
		(228-342)	Fr	0.0011	0.0046	0.0092	0.0138	0.0184	0.0230	0.0321	
			Feed (ipm)	40.0	40.0	40.0	40.0	40.0	40.0	40.0	
M STAINLESS STEELS (FREE MACHINING) 303, 416, 420F, 430F, 440F		≤ 185 Bhn or ≤ 9 HRc	275	RPM	33616	8404	4202	2801	2101	1681	1201
			(220-330)	Fr	0.0006	0.0026	0.0051	0.0077	0.0102	0.0128	0.0179
				Feed (ipm)	21.5	21.5	21.5	21.5	21.5	21.5	21.5
		≤ 275 Bhn or ≤ 28 HRc	170	RPM	20781	5195	2598	1732	1299	1039	742
			(136-204)	Fr	0.0005	0.0020	0.0040	0.0061	0.0081	0.0101	0.0141
				Feed (ipm)	10.5	10.5	10.5	10.5	10.5	10.5	10.5
	≤ 275 Bhn or ≤ 28 HRc	90	RPM	11002	2750	1375	917	688	550	393	
		(72-108)	Fr	0.0005	0.0020	0.0040	0.0060	0.0080	0.0100	0.0140	
			Feed (ipm)	5.5	5.5	5.5	5.5	5.5	5.5	5.5	
	≤ 375 Bhn or ≤ 40 HRc	65	RPM	7946	1986	993	662	497	397	284	
		(52-78)	Fr	0.0004	0.0018	0.0035	0.0053	0.0070	0.0088	0.0123	
			Feed (ipm)	3.5	3.5	3.5	3.5	3.5	3.5	3.5	

continued on next page

Series 135 3D Fractional	Hardness	Vc (sfm)	Diameter (D ₁) (inch)								
			1/32	1/8	1/4	3/8	1/2	5/8	7/8		
S SUPER ALLOYS (NICKEL, COBALT, IRON BASE) Inconel 601, 617, 625, Incoloy, Monel 400, Rene, Waspaloy	≤ 300 Bhn or ≤ 32 HRc	55	RPM	6723	1681	840	560	420	336	240	
		(44-66)	Fr	0.0002	0.0008	0.0015	0.0023	0.0031	0.0039	0.0054	
			Feed (ipm)	1.3	1.3	1.3	1.3	1.3	1.3	1.3	
	≤ 400 Bhn or ≤ 43 HRc	30	RPM	3667	917	458	306	229	183	131	
		(24-36)	Fr	0.0002	0.0007	0.0013	0.0020	0.0026	0.0033	0.0046	
			Feed (ipm)	0.6	0.6	0.6	0.6	0.6	0.6	0.6	
	TITANIUM ALLOYS Pure Titanium, Ti6Al4V, Ti6Al2Sn4Zr2Mo, Ti4Al4Mo2Sn0.5Si, Ti-6Al4V	≤ 275 Bhn or ≤ 28 HRc	135	RPM	16502	4126	2063	1375	1031	825	589
			(108-162)	Fr	0.0004	0.0018	0.0035	0.0053	0.0071	0.0088	0.0124
				Feed (ipm)	7.3	7.3	7.3	7.3	7.3	7.3	7.3
		≤ 350 Bhn or ≤ 38 HRc	100	RPM	12224	3056	1528	1019	764	611	437
			(80-120)	Fr	0.0004	0.0016	0.0033	0.0049	0.0065	0.0082	0.0115
				Feed (ipm)	5.0	5.0	5.0	5.0	5.0	5.0	5.0
≤ 440 Bhn or ≤ 47 HRc		55	RPM	6723	1681	840	560	420	336	240	
		(44-66)	Fr	0.0003	0.0012	0.0024	0.0036	0.0048	0.0059	0.0083	
			Feed (ipm)	2.0	2.0	2.0	2.0	2.0	2.0	2.0	
N ALUMINUM ALLOYS 2017, 2024, 356, 6061, 7075		≤ 80 Bhn or ≤ 47 HRb	700	RPM	85568	21392	10696	7131	5348	4278	3056
			(560-840)	Fr	0.0012	0.0049	0.0098	0.0147	0.0196	0.0245	0.0344
				Feed (ipm)	105.0	105.0	105.0	105.0	105.0	105.0	105.0
	≤ 150 Bhn or ≤ 7 HRc	600	RPM	73344	18336	9168	6112	4584	3667	2619	
		(480-720)	Fr	0.0012	0.0050	0.0099	0.0149	0.0199	0.0248	0.0347	
			Feed (ipm)	91.0	91.0	91.0	91.0	91.0	91.0	91.0	
	COPPER ALLOYS Alum Bronze, C110, Muntz Brass	≤ 140 Bhn or ≤ 3 HRc	500	RPM	61120	15280	7640	5093	3820	3056	2183
			(400-600)	Fr	0.0005	0.0020	0.0039	0.0059	0.0079	0.0098	0.0137
				Feed (ipm)	30.0	30.0	30.0	30.0	30.0	30.0	30.0
		≤ 200 Bhn or ≤ 23 HRc	400	RPM	48896	12224	6112	4075	3056	2445	1746
			(320-480)	Fr	0.0005	0.0020	0.0040	0.0060	0.0080	0.0100	0.0140
				Feed (ipm)	24.5	24.5	24.5	24.5	24.5	24.5	24.5

Bhn (Brinell) HRc (Rockwell C) HRb (Rockwell B)

$rpm = Vc \times 3.82 / D_1$

$ipm = Fr \times rpm$

reduce speed and feed for materials harder than listed

refer to the KYOCERA SGS Tool Wizard® for complete technical information (www.kyocera-sgstool.com)

Hi-PerCarb

Series 135 3D Metric	Hardness	Vc (m/min)	Diameter (D ₁) (inch)									
			1.5	3	6	8	10	12	16	20		
P CARBON STEELS 1018, 1040, 1080, 1090, 10L50, 1140, 1212, 12L15, 1525, 1536	≤ 175 Bhn or ≤ 7 HRc	117	RPM	24882	12441	6220	4665	3732	3110	2333	1866	
		(94-141)	Fr	0.047	0.094	0.189	0.252	0.315	0.378	0.504	0.630	
			Feed (mm/min)	1175	1175	1175	1175	1175	1175	1175	1175	1175
	≤ 275 Bhn or ≤ 28 HRc	107	RPM	22620	11310	5655	4241	3393	2827	2121	1696	
		(85-128)	Fr	0.043	0.086	0.172	0.229	0.286	0.343	0.457	0.572	
			Feed (mm/min)	970	970	970	970	970	970	970	970	970
	≤ 475 Bhn or ≤ 45 HRc	61	RPM	12926	6463	3231	2424	1939	1616	1212	969	
		(49-73)	Fr	0.036	0.071	0.142	0.190	0.237	0.285	0.380	0.475	
			Feed (mm/min)	460	460	460	460	460	460	460	460	460
	H ALLOY STEELS 4140, 4150, 4320, 5120, 5150, 8630, 86L20, 50100	≤ 275 Bhn or ≤ 28 HRc	91	RPM	19388	9694	4847	3635	2908	2424	1818	1454
			(73-110)	Fr	0.036	0.071	0.142	0.190	0.237	0.285	0.380	0.475
				Feed (mm/min)	690	690	690	690	690	690	690	690
≤ 375 Bhn or ≤ 40 HRc		56	RPM	11956	5978	2989	2242	1793	1495	1121	897	
		(45-68)	Fr	0.031	0.061	0.122	0.163	0.204	0.244	0.326	0.407	
			Feed (mm/min)	365	365	365	365	365	365	365	365	365
≤ 450 Bhn or ≤ 48 HRc		40	RPM	8402	4201	2100	1575	1260	1050	788	630	
		(32-48)	Fr	0.021	0.042	0.083	0.111	0.139	0.167	0.222	0.278	
			Feed (mm/min)	175	175	175	175	175	175	175	175	175
K TOOL STEELS A2, D2, H13, L2, M2, P20, S7, T15, W2		≤ 200 Bhn or ≤ 13 HRc	40	RPM	8402	4201	2100	1575	1260	1050	788	630
			(32-48)	Fr	0.032	0.063	0.126	0.168	0.210	0.252	0.336	0.421
				Feed (mm/min)	265	265	265	265	265	265	265	265
	≤ 375 Bhn or ≤ 40 HRc	27	RPM	5816	2908	1454	1091	872	727	545	436	
		(22-33)	Fr	0.014	0.028	0.055	0.073	0.092	0.110	0.147	0.183	
			Feed (mm/min)	80	80	80	80	80	80	80	80	80
	≤ 475 Bhn or ≤ 50 HRc	23	RPM	4847	2424	1212	909	727	606	454	364	
		(18-27)	Fr	0.009	0.019	0.037	0.050	0.062	0.074	0.099	0.124	
			Feed (mm/min)	45	45	45	45	45	45	45	45	45
	M CAST IRONS Gray, Malleable, Ductile	≤ 220 Bhn or ≤ 19 HRc	98	RPM	20681	10340	5170	3878	3102	2585	1939	1551
			(78-117)	Fr	0.055	0.110	0.220	0.293	0.366	0.439	0.585	0.732
				Feed (mm/min)	1135	1135	1135	1135	1135	1135	1135	1135
≤ 260 Bhn or ≤ 26 HRc		87	RPM	18419	9209	4605	3454	2763	2302	1727	1381	
		(69-104)	Fr	0.055	0.110	0.219	0.292	0.366	0.439	0.585	0.731	
			Feed (mm/min)	1010	1010	1010	1010	1010	1010	1010	1010	1010
M STAINLESS STEELS (FREE MACHINING) 303, 416, 420F, 430F, 440F	≤ 185 Bhn or ≤ 9 HRc	84	RPM	17773	8886	4443	3332	2666	2222	1666	1333	
		(67-101)	Fr	0.031	0.061	0.123	0.164	0.204	0.245	0.327	0.409	
			Feed (mm/min)	545	545	545	545	545	545	545	545	545
	≤ 275 Bhn or ≤ 28 HRc	52	RPM	10987	5493	2747	2060	1648	1373	1030	824	
		(41-62)	Fr	0.024	0.047	0.095	0.126	0.158	0.189	0.252	0.316	
			Feed (mm/min)	260	260	260	260	260	260	260	260	260
	M STAINLESS STEELS (DIFFICULT) 304, 316, 321, 13-8 PH, 15-5PH, 17-4 PH, Custom 450	≤ 275 Bhn or ≤ 28 HRc	27	RPM	5816	2908	1454	1091	872	727	545	436
			(22-33)	Fr	0.023	0.046	0.093	0.124	0.155	0.186	0.248	0.309
				Feed (mm/min)	135	135	135	135	135	135	135	135
		≤ 375 Bhn or ≤ 40 HRc	20	RPM	4201	2100	1050	788	630	525	394	315
			(16-24)	Fr	0.020	0.040	0.081	0.108	0.135	0.162	0.216	0.270
				Feed (mm/min)	85	85	85	85	85	85	85	85

continued on next page

Series 135 3D Metric	Hardness	Vc (m/min)	Diameter (D ₁) (inch)									
			1.5	3	6	8	10	12	16	20		
SUPER ALLOYS (NICKEL, COBALT, IRON BASE) Inconel 601, 617, 625, Incoloy, Monel 400, Rene, Waspaloy	≤ 300 Bhn or ≤ 32 HRc	17	RPM	3555	1777	889	666	533	444	333	267	
		(13-20)	Fr	0.010	0.020	0.039	0.053	0.066	0.079	0.105	0.131	
			Feed (mm/min)	35	35	35	35	35	35	35	35	
	≤ 400 Bhn or ≤ 43 HRc	9	RPM	1939	969	485	364	291	242	182	145	
		(7-11)	Fr	0.008	0.015	0.031	0.041	0.052	0.062	0.083	0.103	
			Feed (mm/min)	15	15	15	15	15	15	15	15	
	TITANIUM ALLOYS Pure Titanium, Ti6Al4V, Ti6Al2Sn4Zr2Mo, Ti4Al4Mo2Sn0.5Si, Ti-6Al4V	≤ 275 Bhn or ≤ 28 HRc	41	RPM	8725	4362	2181	1636	1309	1091	818	654
			(33-49)	Fr	0.021	0.042	0.085	0.113	0.141	0.170	0.226	0.283
				Feed (mm/min)	185	185	185	185	185	185	185	185
		≤ 350 Bhn or ≤ 38 HRc	30	RPM	6463	3231	1616	1212	969	808	606	485
			(24-37)	Fr	0.019	0.039	0.077	0.103	0.129	0.155	0.206	0.258
				Feed (mm/min)	125	125	125	125	125	125	125	125
≤ 440 Bhn or ≤ 47 HRc		17	RPM	3555	1777	889	666	533	444	333	267	
		(13-20)	Fr	0.014	0.028	0.056	0.075	0.094	0.113	0.150	0.188	
			Feed (mm/min)	50	50	50	50	50	50	50	50	
ALUMINUM ALLOYS 2017, 2024, 356, 6061, 7075		≤ 80 Bhn or ≤ 47 HRb	213	RPM	45239	22620	11310	8482	6786	5655	4241	3393
			(171-256)	Fr	0.059	0.119	0.238	0.317	0.396	0.476	0.634	0.793
				Feed (mm/min)	2690	2690	2690	2690	2690	2690	2690	2690
	≤ 150 Bhn or ≤ 7 HRc	183	RPM	38777	19388	9694	7271	5816	4847	3635	2908	
		(146-219)	Fr	0.060	0.120	0.240	0.320	0.400	0.480	0.640	0.799	
			Feed (mm/min)	2325	2325	2325	2325	2325	2325	2325	2325	
	COPPER ALLOYS Alum Bronze, C110, Muntz Brass	≤ 140 Bhn or ≤ 3 HRc	152	RPM	32314	16157	8078	6059	4847	4039	3029	2424
			(122-183)	Fr	0.024	0.048	0.096	0.128	0.160	0.192	0.256	0.320
				Feed (mm/min)	776	776	776	776	776	776	776	776
		≤ 200 Bhn or ≤ 23 HRc	122	RPM	25851	12926	6463	4847	3878	3231	2424	1939
			(98-146)	Fr	0.024	0.049	0.097	0.130	0.162	0.195	0.260	0.325
				Feed (mm/min)	630	630	630	630	630	630	630	630

Bhn (Brinell) HRc (Rockwell C) HRb (Rockwell B)
 $rpm = (Vc \times 1000) / (D_1 \times 3.14)$
 $mm/min = Fr \times rpm$
 reduce speed and feed for materials harder than listed
 refer to the KYOCERA SGS Tool Wizard® for complete technical information (www.kyocera-sgstool.com)

Hi-PerCarb



5xD



2

135 5xD

FRACTIONAL & METRIC SERIES

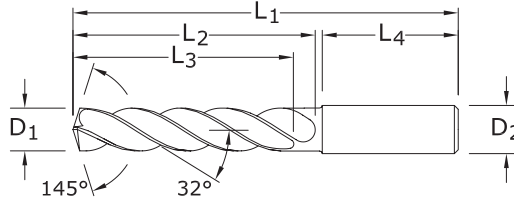

- Double margin design improves accuracy and surface finish along with increased strength for aggressive drilling
- Specialized self-centering notched point eliminates the need for spot drilling decreasing thrust and deflection
- Engineered edge protection improves edge strength and reduces edge fatigue allowing for increased feed rates
- Recommended for materials ≤ 56 HRc (≤ 577 Bhn)

CUTTING DIAMETER	DECIMAL EQUIV.	METRIC EQUIV.	TAP SIZE REFERENCE ONLY	SHANK DIAMETER	OVERALL LENGTH	FLUTE LENGTH	CLEARED LENGTH	SHANK LENGTH	Ti-NAMITE-A (AlTiN)
D ₁				D ₂	L ₁	L ₂	L ₃	L ₄	EDP NO.
1/64	0.0156	0.40		1/8	1 1/2	5/32	7/64	1	52300*
1/32	0.0312	0.79		1/8	1 1/2	5/16	7/32	1	52301*
3/64	0.0469	1.19	1/16-64	1/8	1 1/2	25/64	19/64	1	52302*
1,25 mm	0.0492			3,0	38,0	10,0	7,5	25,0	64520*
1,45 mm	0.0571			3,0	38,0	10,0	7,5	25,0	64521*
#53	0.0595	1.51		1/8	1-1/2	25/64	19/64	1	64522*
1/16	0.0625	1.59	5/64-60	1/8	2	15/32	23/64	1-1/4	52303*
1,6 mm	0.0630			3,0	50,0	12,0	9,0	32,0	64523*
1,75 mm	0.0689			3,0	50,0	12,0	9,0	32,0	64524*
#50	0.0700	1.78		1/8	2	15/32	23/64	1-1/4	64525*
5/64	0.0781	1.98		1/8	2	35/64	27/64	1-1/4	52304*
#47	0.0785	1.99		1/8	2	35/64	27/64	1-1/4	64526*
2,05 mm	0.0807			3,0	50,0	14,0	11,0	32,0	64527*
#46	0.0810	2.06		1/8	2	35/64	27/64	1-1/4	64528*
#43	0.0890	2.26		1/8	2	19/32	15/32	1-1/4	64529*
#42	0.0935	2.37		1/8	2	5/8	1/2	1-1/4	64530*
3/32	0.0938	2.38	1/8-32	1/8	2	5/8	1/2	1-1/4	52305
#40	0.0980	2.49		1/8	2	43/64	17/32	1-1/4	52306
2,5 mm	0.0984			3,0	50,0	17,0	13,0	32,0	64531
#39	0.0995	2.53		1/8	2	43/64	17/32	1-1/4	52307
#38	0.1015	2.58	5-40	1/8	2	43/64	17/32	1-1/4	52308
#37	0.1040	2.64	5-44	1/8	2	45/64	9/16	1-1/4	52309
#36	0.1065	2.71	6-32	1/8	2	45/64	9/16	1-1/4	52310
7/64	0.1094	2.78		1/8	2	3/4	19/32	1-1/4	52311
#35	0.1100	2.79		1/8	2	3/4	19/32	1-1/4	52312
#34	0.1110	2.82		1/8	2	3/4	19/32	1-1/4	52313
#33	0.1130	2.87	6-40	1/8	2	3/4	19/32	1-1/4	52314
2,9 mm	0.1142			3,0	50,0	19,0	15,0	32,0	64532
#32	0.1160	2.95		1/8	2	3/4	39/64	1-1/4	52315
3,0 mm	0.1181			6,0	66,0	28,0	23,0	36,0	64100
#31	0.1200	3.05		1/8	2	3/4	39/64	1-1/4	52316
3,1 mm	0.1220			6,0	66,0	28,0	23,0	36,0	64101
1/8	0.1250	3.18		1/4	3	1	53/64	1-7/16	51580
3,2 mm	0.1260		M3,5 X 0,35	6,0	66,0	28,0	23,0	36,0	64102
#30	0.1285	3.26		1/4	3	1	53/64	1-7/16	51581
3,3 mm	0.1299		M4 X 0,7	6,0	66,0	28,0	23,0	36,0	64103
3,4 mm	0.1339		8-32,8-36	6,0	66,0	28,0	23,0	36,0	64104
#29	0.1360	3.45		1/4	3	1	53/64	1-7/16	51582

*Single Margin

continued on next page

TOLERANCES (inch)

$\leq .1181$ DIAMETER

D₁ = +.0008/+0.0047

D₂ = h₆

>.1181-.2362 DIAMETER

D₁ = +.00016/+0.0063

D₂ = h₆

>.2362-.3937 DIAMETER

D₁ = +.00024/+0.0083

D₂ = h₆

>.3937-.7087 DIAMETER

D₁ = +.00028/+0.0098

D₂ = h₆

>.7087-1.1811 DIAMETER

D₁ = +.00031/+0.0114

D₂ = h₆

TOLERANCES (mm)

≤ 3 DIAMETER

D₁ = +0,002/+0,012

D₂ = h₆

>3-6 DIAMETER

D₁ = +0,004/+0,016

D₂ = h₆

>6-10 DIAMETER

D₁ = +0,006/+0,021

D₂ = h₆

>10-18 DIAMETER

D₁ = +0,007/+0,025

D₂ = h₆

>18-30 DIAMETER

D₁ = +0,008/+0,029

D₂ = h₆

STEELS

STAINLESS STEELS

CAST IRON

HIGH TEMP ALLOYS

TITANIUM

NON-FERROUS

HARDENED STEELS

For patent information visit www.ksptpatents.com



135 5xD

FRACTIONAL & METRIC SERIES

CUTTING DIAMETER	DECIMAL EQUIV.	METRIC EQUIV.	TAP SIZE REFERENCE ONLY	SHANK DIAMETER	OVERALL LENGTH	FLUTE LENGTH	CLEARED LENGTH	SHANK LENGTH	Ti-NAMITE-A (AITIN)
D ₁				D ₂	L ₁	L ₂	L ₃	L ₄	EDP NO.
3,5 mm	0.1378			6,0	66,0	28,0	23,0	36,0	64105
#28	0.1405	3.57	8-40	1/4	3	1	53/64	1-7/16	52317
9/64	0.1406	3.57		1/4	3	1	53/64	1-7/16	51583
3,6 mm	0.1417		M4 X 0,35	6,0	66,0	28,0	23,0	36,0	64106
#27	0.1440	3.66		1/4	3	1	53/64	1-7/16	52318
3,7 mm	0.1457		M4.5 X 0,75	6,0	66,0	28,0	23,0	36,0	64107
#26	0.1470	3.73	3/16-24	1/4	3	1	53/64	1-7/16	52319
#25	0.1495	3.80	10-24	1/4	3-1/4	1-1/4	1-5/64	1-7/16	51584
3,8 mm	0.1496			6,0	74,0	36,0	29,0	36,0	64108
#24	0.1520	3.86	10-28	1/4	3-1/4	1-1/4	1-5/64	1-7/16	52321
3,9 mm	0.1535			6,0	74,0	36,0	29,0	36,0	64109
#23	0.1540	3.91		1/4	3-1/4	1-1/4	1-5/64	1-7/16	52322
5/32	0.1562	3.97		1/4	3-1/4	1-1/4	1-5/64	1-7/16	51585
#22	0.1570	3.99	10-30	1/4	3-1/4	1-1/4	1-5/64	1-7/16	52323
4,0 mm	0.1575		M4,5 X 0,5	6,0	74,0	36,0	29,0	36,0	64110
#21	0.1590	4.04	10-32	1/4	3-1/4	1-1/4	1-5/64	1-7/16	51586
#20	0.1610	4.09	13/64-24	1/4	3-1/4	1-1/4	1-5/64	1-7/16	51587
4,1 mm	0.1614			6,0	74,0	36,0	29,0	36,0	64111
4,2 mm	0.1654		M5 / M5 X 0,75	6,0	74,0	36,0	29,0	36,0	64112
#19	0.1660	4.22		1/4	3-1/4	1-1/4	1-5/64	1-7/16	52324
4,3 mm	0.1693			6,0	74,0	36,0	29,0	36,0	64113
#18	0.1695	4.31		1/4	3-1/4	1-1/4	1-5/64	1-7/16	52325
11/64	0.1719	4.37		1/4	3-1/4	1-1/4	1-5/64	1-7/16	51588
#17	0.1730	4.39		1/4	3-1/4	1-1/4	1-5/64	1-7/16	52326
4,4 mm	0.1732			6,0	74,0	36,0	29,0	36,0	64114
4,5 mm	0.1772		M5 X 0,5	6,0	74,0	36,0	29,0	36,0	64115
#15	0.1800	4.57		1/4	3-1/4	1-1/4	1-5/64	1-7/16	52327
4,6 mm	0.1811		12-28	6,0	74,0	36,0	29,0	36,0	64116
#14	0.1820	4.62		1/4	3-1/4	1-1/4	1-5/64	1-7/16	52328
#13	0.1850	4.70	12-32	1/4	3-1/4	1-1/4	1-5/64	1-7/16	52329
4,7 mm	0.1850			6,0	74,0	36,0	29,0	36,0	64117
3/16	0.1875	4.76		1/4	3-1/4	1-3/4	1-37/64	1-7/16	51589
#12	0.1890	4.80	7/32-32	1/4	3-1/4	1-3/4	1-37/64	1-7/16	52330
4,8 mm	0.1890			6,0	82,0	44,0	35,0	36,0	64118
4,9 mm	0.1929			6,0	82,0	44,0	35,0	36,0	64119
#10	0.1935	4.91	14-20	1/4	3-1/4	1-3/4	1-37/64	1-7/16	52331
#9	0.1960	4.98		1/4	3-1/4	1-3/4	1-37/64	1-7/16	52332
5,0 mm	0.1969		M6 X 1	6,0	82,0	44,0	35,0	36,0	64120
#8	0.1990	5.05		1/4	3-1/4	1-3/4	1-37/64	1-7/16	52333
5,1 mm	0.2008			6,0	82,0	44,0	35,0	36,0	64121
#7	0.2010	5.11	1/4-20	1/4	3-1/4	1-3/4	1-37/64	1-7/16	51506
13/64	0.2031	5.16		1/4	3-1/4	1-3/4	1-37/64	1-7/16	51507
#6	0.2040	5.18		1/4	3 1/4	1 3/4	1 37/64	1 7/16	52334
5,2 mm	0.2047		M6 X 0,75	6,0	82,0	44,0	35,0	36,0	64122
#5	0.2055	5.22		1/4	3-1/4	1-3/4	1-37/64	1-7/16	51590
5,25 mm	0.2067			6,0	82,0	44,0	35,0	36,0	64123
5,3 mm	0.2087			6,0	82,0	44,0	35,0	36,0	64124
#4	0.2090	5.31	1/4-24	1/4	3-1/4	1-3/4	1-37/64	1-7/16	51508

CONTINUED

continued on next page

Hi-PerCarb



5xD



2

135 5xD

FRACTIONAL & METRIC SERIES

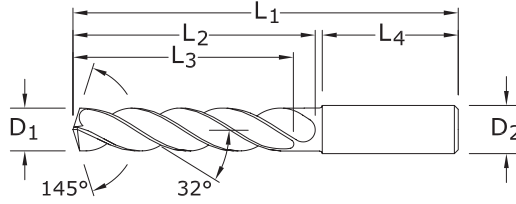

- Double margin design improves accuracy and surface finish along with increased strength for aggressive drilling
- Specialized self-centering notched point eliminates the need for spot drilling decreasing thrust and deflection
- Engineered edge protection improves edge strength and reduces edge fatigue allowing for increased feed rates
- Recommended for materials ≤ 56 HRc (≤ 577 Bhn)

CUTTING DIAMETER	DECIMAL EQUIV.	METRIC EQUIV.	TAP SIZE REFERENCE ONLY	SHANK DIAMETER	OVERALL LENGTH	FLUTE LENGTH	CLEARED LENGTH	SHANK LENGTH	Ti-NAMITE-A (AITiN)
D ₁				D ₂	L ₁	L ₂	L ₃	L ₄	EDP NO.
5,4 mm	0.2126			6,0	82,0	44,0	35,0	36,0	64125
#3	0.2130	5.41	1/4-28	1/4	3-1/4	1-3/4	1-37/64	1-7/16	51509
5,5 mm	0.2165		M6 X 0,5	6,0	82,0	44,0	35,0	36,0	64126
7/32	0.2188	5.56	1/4-32	1/4	3-1/4	1-3/4	1-37/64	1-7/16	51510
5,6 mm	0.2205			6,0	82,0	44,0	35,0	36,0	64127
#2	0.2210	5.61		1/4	3-1/4	1-3/4	1-37/64	1-7/16	52335
5,7 mm	0.2244			6,0	82,0	44,0	35,0	36,0	64128
#1	0.2280	5.79		1/4	3-1/4	1-3/4	1-37/64	1-7/16	52336
5,8 mm	0.2283			6,0	82,0	44,0	35,0	36,0	64129
A	0.2340	5.94		1/4	3-1/4	1-3/4	1-37/64	1-7/16	52337
15/64	0.2344	5.95		1/4	3-1/4	1-3/4	1-37/64	1-7/16	51591
6,0 mm	0.2362		M7 X 1	6,0	82,0	44,0	35,0	36,0	64131
B	0.2380	6.05		1/4	3 5/8	2-5/64	1-51/64	1-7/16	52338
6,1 mm	0.2402			8,0	91,0	53,0	43,0	36,0	64132
C	0.2420	6.15		1/4	3 5/8	2-5/64	1-51/64	1-7/16	52339
6,2 mm	0.2441			8,0	91,0	53,0	43,0	36,0	64133
D	0.2460	6.25		1/4	3 5/8	2-5/64	1-51/64	1-7/16	52340
6,25 mm	0.2461		M7 X 0,75	8,0	91,0	53,0	43,0	36,0	64134
6,3 mm	0.2480			8,0	91,0	53,0	43,0	36,0	64135
1/4	0.2500	6.35		1/4	3-5/8	2-5/64	1-51/64	1-7/16	51511
6,4 mm	0.2520			8,0	91,0	53,0	43,0	36,0	64136
6,5 mm	0.2559			8,0	91,0	53,0	43,0	36,0	64137
F	0.2570	6.53	5/16-18	5/16	3-5/8	2-5/64	1-51/64	1-7/16	51512
6,6 mm	0.2598			8,0	91,0	53,0	43,0	36,0	64138
G	0.2610	6.63		5/16	3 5/8	2 5/64	1 51/64	1 7/16	52341
6,7 mm	0.2638			8,0	91,0	53,0	43,0	36,0	64139
17/64	0.2656	6.75	5/16-20	5/16	3-5/8	2-5/64	1-51/64	1-7/16	51513
H	0.2660	6.76		5/16	3-5/8	2-5/64	1-51/64	1-7/16	52342
6,8 mm	0.2677		M8 X 1,25	8,0	91,0	53,0	43,0	36,0	64140
6,9 mm	0.2717			8,0	91,0	53,0	43,0	36,0	64141
I	0.2720	6.91	5/16-24	5/16	3-5/8	2-5/64	1-51/64	1-7/16	51514
7,0 mm	0.2756		M8 X 1	8,0	91,0	53,0	43,0	36,0	64142
J	0.2770	7.04		5/16	3 5/8	2-5/64	1-51/64	1-7/16	52343
7,1 mm	0.2795			8,0	91,0	53,0	43,0	36,0	64143
K	0.2810	7.14		5/16	3 5/8	2-5/64	1-51/64	1-7/16	52344
9/32	0.2812	7.14	5/16-32	5/16	3-5/8	2-5/64	1-51/64	1-7/16	51515
7,2 mm	0.2835			8,0	91,0	53,0	43,0	36,0	64144

TOLERANCES (inch)

$\leq .1181$ DIAMETER

D₁ = +.00008/+0.00047

D₂ = h₆

>.1181-.2362 DIAMETER

D₁ = +.00016/+0.00063

D₂ = h₆

>.2362-.3937 DIAMETER

D₁ = +.00024/+0.00083

D₂ = h₆

>.3937-.7087 DIAMETER

D₁ = +.00028/+0.00098

D₂ = h₆

>.7087-1.1811 DIAMETER

D₁ = +.00031/+0.0114

D₂ = h₆

TOLERANCES (mm)

≤ 3 DIAMETER

D₁ = +0,002/+0,012

D₂ = h₆

>3-6 DIAMETER

D₁ = +0,004/+0,016

D₂ = h₆

>6-10 DIAMETER

D₁ = +0,006/+0,021

D₂ = h₆

>10-18 DIAMETER

D₁ = +0,007/+0,025

D₂ = h₆

>18-30 DIAMETER

D₁ = +0,008/+0,029

D₂ = h₆

STEELS

STAINLESS STEELS

CAST IRON

HIGH TEMP ALLOYS

TITANIUM

NON-FERROUS

HARDENED STEELS

For patent information visit www.ksptpatents.com

continued on next page



135 5xD

FRACTIONAL & METRIC SERIES

CUTTING DIAMETER	DECIMAL EQUIV.	METRIC EQUIV.	TAP SIZE REFERENCE ONLY	SHANK DIAMETER	OVERALL LENGTH	FLUTE LENGTH	CLEARED LENGTH	SHANK LENGTH	Ti-NAMITE-A (AITIN)
D ₁				D ₂	L ₁	L ₂	L ₃	L ₄	EDP NO.
7,25 mm	0.2854		M8 X 0,75	8,0	91,0	53,0	43,0	36,0	64145
7,3 mm	0.2874			8,0	91,0	53,0	43,0	36,0	64146
L	0.2900	7.37		5/16	3-5/8	2-5/64	1-51/64	1-7/16	52345
7,4 mm	0.2913			8,0	91,0	53,0	43,0	36,0	64147
M	0.2950	7.49		5/16	3-5/8	2-5/64	1-51/64	1-7/16	52346
7,5 mm	0.2953		M8 X 0,5	8,0	91,0	53,0	43,0	36,0	64148
19/64	0.2969	7.54		5/16	3-5/8	2-5/64	1-51/64	1-7/16	51516
7,6 mm	0.2992			8,0	91,0	53,0	43,0	36,0	64149
N	0.3020	7.67		5/16	3-5/8	2-5/64	1-51/64	1-7/16	52347
7,7 mm	0.3031			8,0	91,0	53,0	43,0	36,0	64150
7,8 mm	0.3071		M9 X 1,25	8,0	91,0	53,0	43,0	36,0	64151
7,9 mm	0.3110			8,0	91,0	53,0	43,0	36,0	64152
5/16	0.3125	7.94	3/8-16	5/16	3-5/8	2-5/64	1-51/64	1-7/16	51517
8,0 mm	0.3150		M9 X 1	8,0	91,0	53,0	43,0	36,0	64153
O	0.3160	8.03		3/8	4	2-13/32	2-1/8	1-9/16	52348
8,1 mm	0.3189			10,0	103,0	61,0	49,0	40,0	64154
8,2 mm	0.3228			10,0	103,0	61,0	49,0	40,0	64155
P	0.3230	8.20		3/8	4	2-13/32	2-1/8	1-9/16	51518
8,3 mm	0.3268			10,0	103,0	61,0	49,0	40,0	64156
21/64	0.3281	8.33	3/8-20	3/8	4	2-13/32	2-1/8	1-9/16	51519
8,4 mm	0.3307			10,0	103,0	61,0	49,0	40,0	64157
Q	0.3320	8.43	3/8-24	3/8	4	2-13/32	2-1/8	1-9/16	51520
8,5 mm	0.3346		M10 X 1,5	10,0	103,0	61,0	49,0	40,0	64158
8,6 mm	0.3386			10,0	103,0	61,0	49,0	40,0	64159
R	0.3390	8.61	3/8-32	3/8	4	2-13/32	2-1/8	1-9/16	52349
8,7 mm	0.3425		M10 X 1,25	10,0	103,0	61,0	49,0	40,0	64160
11/32	0.3438	8.73		3/8	4	2-13/32	2-1/8	1-9/16	51521
8,8 mm	0.3465			10,0	103,0	61,0	49,0	40,0	64161
S	0.3480	8.84		3/8	4	2-13/32	2-1/8	1-9/16	51522
8,9 mm	0.3504			10,0	103,0	61,0	49,0	40,0	64162
9,0 mm	0.3543		M10 X 1	10,0	103,0	61,0	49,0	40,0	64163
T	0.3580	9.09		3/8	4	2 13/32	2 1/8	1 9/16	52350
9,1 mm	0.3583			10,0	103,0	61,0	49,0	40,0	64164
23/64	0.3594	9.13		3/8	4	2-13/32	2-1/8	1-9/16	51523
9,2 mm	0.3622		M10 X 0,75	10,0	103,0	61,0	49,0	40,0	64165
9,25 mm	0.3642			10,0	103,0	61,0	49,0	40,0	64166
9,3 mm	0.3661			10,0	103,0	61,0	49,0	40,0	64167
U	0.3680	9.35	7/16-14	3/8	4	2-13/32	2-1/8	1-9/16	51524
9,4 mm	0.3701			10,0	103,0	61,0	49,0	40,0	64168
9,5 mm	0.3740		M10 X 0,5	10,0	103,0	61,0	49,0	40,0	64169
3/8	0.3750	9.53		3/8	4	2-13/32	2-1/8	1-9/16	51525
V	0.3770	9.58		1/2	4	2-13/32	2-1/8	1-9/16	52351
9,6 mm	0.3780			10,0	103,0	61,0	49,0	40,0	64170
9,7 mm	0.3819			10,0	103,0	61,0	49,0	40,0	64171
9,8 mm	0.3858			10,0	103,0	61,0	49,0	40,0	64172
W	0.3860	9.80		1/2	4	2-13/32	2-1/8	1-9/16	51526
9,9 mm	0.3898			10,0	103,0	61,0	49,0	40,0	64173
25/64	0.3906	9.92	7/16-20	1/2	4	2-13/32	2-1/8	1-9/16	51527

CONTINUED

continued on next page

Hi-PerCarb



5xD



2

135 5xD

FRACTIONAL & METRIC SERIES

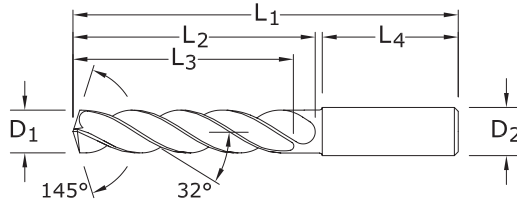

- Double margin design improves accuracy and surface finish along with increased strength for aggressive drilling
- Specialized self-centering notched point eliminates the need for spot drilling decreasing thrust and deflection
- Engineered edge protection improves edge strength and reduces edge fatigue allowing for increased feed rates
- Recommended for materials ≤ 56 HRc (≤ 577 Bhn)

CUTTING DIAMETER	DECIMAL EQUIV.	METRIC EQUIV.	TAP SIZE REFERENCE ONLY	SHANK DIAMETER	OVERALL LENGTH	FLUTE LENGTH	CLEARED LENGTH	SHANK LENGTH	Ti-NAMITE-A (AlTiN)
D ₁				D ₂	L ₁	L ₂	L ₃	L ₄	EDP NO.
10,0 mm	0.3937			10,0	103,0	61,0	49,0	40,0	64174
X	0.3970	10.08	7/16-24	1/2	4-11/16	2-3/4	2-23/64	1-49/64	52352
10,1 mm	0.3976			12,0	118,0	71,0	56,0	45,0	64175
10,2 mm	0.4016			12,0	118,0	71,0	56,0	45,0	64176
Y	0.4040	10.26	7/16-28	1/2	4-11/16	2-3/4	2-23/64	1-49/64	52353
10,3 mm	0.4055			12,0	118,0	71,0	56,0	45,0	64177
13/32	0.4062	10.32		1/2	4-11/16	2-3/4	2-23/64	1-49/64	51528
10,4 mm	0.4095			12,0	118,0	71,0	56,0	45,0	64178
Z	0.4130	10.49		1/2	4-11/16	2-3/4	2-23/64	1-49/64	52354
10,5 mm	0.4134		M12 X 1,5	12,0	118,0	71,0	56,0	45,0	64179
10,6 mm	0.4173			12,0	118,0	71,0	56,0	45,0	64180
10,7 mm	0.4213			12,0	118,0	71,0	56,0	45,0	64181
27/64	0.4219	10.72	1/2-13	1/2	4-11/16	2-3/4	2-23/64	1-49/64	51529
10,8 mm	0.4252		M12 X 1,25	12,0	118,0	71,0	56,0	45,0	64182
10,9 mm	0.4291			12,0	118,0	71,0	56,0	45,0	64183
11,0 mm	0.4331			12,0	118,0	71,0	56,0	45,0	64184
11,1 mm	0.4370		M12 X 1	12,0	118,0	71,0	56,0	45,0	64185
7/16	0.4375	11.11	1/4-18 NPT	1/2	4-11/16	2-3/4	2-23/64	1-49/64	51530
11,2 mm	0.4409			12,0	118,0	71,0	56,0	45,0	64186
11,25 mm	0.4429			12,0	118,0	71,0	56,0	45,0	64187
11,3 mm	0.4449			12,0	118,0	71,0	56,0	45,0	64188
11,4 mm	0.4488			12,0	118,0	71,0	56,0	45,0	64189
11,5 mm	0.4528		M12 X 0,5	12,0	118,0	71,0	56,0	45,0	64190
29/64	0.4531	11.51	1/2-20	1/2	4-11/16	2-3/4	2-23/64	1-49/64	51531
11,6 mm	0.4567			12,0	118,0	71,0	56,0	45,0	64191
11,7 mm	0.4606			12,0	118,0	71,0	56,0	45,0	64192
11,8 mm	0.4646			12,0	118,0	71,0	56,0	45,0	64193
11,9 mm	0.4685			12,0	118,0	71,0	56,0	45,0	64194
15/32	0.4688	11.91	1/2-28	1/2	4-11/16	2-3/4	2-23/64	1-49/64	51532
12,0 mm	0.4724		M14 X 2	12,0	118,0	71,0	56,0	45,0	64195
31/64	0.4844	12.30	9/16-12	1/2	4-7/8	3-1/32	2-19/32	1-49/64	51533
12,5 mm	0.4921		M14 X 1,5	14,0	124,0	77,0	60,0	45,0	64196
1/2	0.5000	12.70		1/2	4-7/8	3-1/32	2-19/32	1-49/64	51534
12,8 mm	0.5039		M14 X 1,25	14,0	124,0	77,0	60,0	45,0	64197
13,0 mm	0.5118		M14 X 1	14,0	124,0	77,0	60,0	45,0	64198
33/64	0.5156	13.10	9/16-18	5/8	4-7/8	3-1/32	2-19/32	1-49/64	51535
17/32	0.5312	13.49	5/8-11	5/8	4-7/8	3-1/32	2-19/32	1-49/64	51536
13,5 mm	0.5315			14,0	124,0	77,0	60,0	45,0	64199

TOLERANCES (inch)

- $\leq .1181$ DIAMETER
D₁ = +.0008/+0.0047
D₂ = h₆
- $>.1181-.2362$ DIAMETER
D₁ = +.00016/+0.00063
D₂ = h₆
- $>.2362-.3937$ DIAMETER
D₁ = +.00024/+0.00083
D₂ = h₆
- $>.3937-.7087$ DIAMETER
D₁ = +.00028/+0.00098
D₂ = h₆
- $>.7087-1.1811$ DIAMETER
D₁ = +.00031/+0.0114
D₂ = h₆

TOLERANCES (mm)

- ≤ 3 DIAMETER
D₁ = +0,002/+0,012
D₂ = h₆
- $>3-6$ DIAMETER
D₁ = +0,004/+0,016
D₂ = h₆
- $>6-10$ DIAMETER
D₁ = +0,006/+0,021
D₂ = h₆
- $>10-18$ DIAMETER
D₁ = +0,007/+0,025
D₂ = h₆
- $>18-30$ DIAMETER
D₁ = +0,008/+0,029
D₂ = h₆

- STEELS
- STAINLESS STEELS
- CAST IRON
- HIGH TEMP ALLOYS
- TITANIUM
- NON-FERROUS
- HARDENED STEELS

For patent information visit www.ksptpatents.com

continued on next page



135 5xD

FRACTIONAL & METRIC SERIES

CUTTING DIAMETER	DECIMAL EQUIV.	METRIC EQUIV.	TAP SIZE REFERENCE ONLY	SHANK DIAMETER	OVERALL LENGTH	FLUTE LENGTH	CLEARED LENGTH	SHANK LENGTH	Ti-NAMITE-A (AITIN)
D ₁				D ₂	L ₁	L ₂	L ₃	L ₄	EDP NO.
35/64	0.5469	13.89	5/8-12	5/8	4-7/8	3-1/32	2-19/32	1-49/64	51537
14,0 mm	0.5512		M16 X 2	14,0	124,0	77,0	60,0	45,0	64200
9/16	0.5625	14.29		5/8	5-1/4	3-1/4	2-3/4	1-57/64	51538
14,5 mm	0.5709		M16 X 1,5	16,0	133,0	83,0	63,0	48,0	64201
37/64	0.5781	14.68	5/8-18	5/8	5-1/4	3-1/4	2-3/4	1-57/64	51539
15,0 mm	0.5906		M16 X 1	16,0	133,0	83,0	63,0	48,0	64202
19/32	0.5938	15.08	11/16-11	5/8	5-1/4	3-1/4	2-3/4	1-57/64	51592
39/64	0.6094	15.48	11/16-12	5/8	5-1/4	3-1/4	2-3/4	1-57/64	51593
15,5 mm	0.6102		M18 X 2,5	16,0	133,0	83,0	63,0	48,0	64203
5/8	0.6250	15.88	11/16-16	5/8	5-1/4	3-1/4	2-3/4	1-57/64	51540
16,0 mm	0.6299			16,0	133,0	83,0	63,0	48,0	64204
41/64	0.6406	16.27	11/16-24	3/4	5-5/8	3-5/8	3-3/16	1-57/64	51594
16,5 mm	0.6496		M18 X 1,5	18,0	143,0	93,0	71,0	48,0	64205
21/32	0.6562	16.67	3/4-10	3/4	5-5/8	3-5/8	3-3/16	1-57/64	51541
17,0 mm	0.6693			18,0	143,0	93,0	71,0	48,0	64206
43/64	0.6719	17.07	3/4-12	3/4	5-5/8	3-5/8	3-3/16	1-57/64	51595
11/16	0.6875	17.46	3/4-16	3/4	5-5/8	3-5/8	3-3/16	1-57/64	51542
17,5 mm	0.6890		M20 X 2,5	18,0	143,0	93,0	71,0	48,0	64207
45/64	0.7031	17.86	3/4-20, 1/2-14 NPT	3/4	5-5/8	3-5/8	3-3/16	1-57/64	51543
18,0 mm	0.7087			18,0	143,0	93,0	71,0	48,0	64208
23/32	0.7188	18.26		3/4	6	4	3-3/8	1-31/32	51596
18,5 mm	0.7283		M20 X 1,5	20,0	153,0	101,0	77,0	50,0	64209
47/64	0.7344	18.65	13/16-12	3/4	6	4	3-3/8	1-31/32	51544
19,0 mm	0.7480			20,0	153,0	101,0	77,0	50,0	64210
3/4	0.7500	19.05	13/16-16	3/4	6	4	3-3/8	1-31/32	51545
49/64	0.7656	19.45	7/8-9	7/8	6	4	3-3/8	1-31/32	52355
19,5 mm	0.7677		M22 X 2,5	20,0	153,0	101,0	77,0	50,0	64211
25/32	0.7812	19.84		7/8	6	4	3-3/8	1-31/32	52356
20,0 mm	0.7874			20,0	153,0	101,0	77,0	50,0	64212
51/64	0.7969	20.24	7/8-12	7/8	6	4	3-3/8	1-31/32	52357
20,5 mm	0.8071			22,0	153,0	101,0	77,0	50,0	64533
13/16	0.8125	20.64	7/8-14	7/8	6-1/2	4-1/2	3-7/8	1-31/32	52358
21,0 mm	0.8268			22,0	153,0	101,0	77,0	50,0	64534
22,0 mm	0.8661			22,0	178,0	127,0	108,0	50,0	64535
7/8	0.8750	22.23	15/16-16, 1-8	7/8	6-1/2	4-1/2	3-7/8	1-31/32	52359
59/64	0.9219	23.42	1-12	1	7	5	4-3/8	2-1/8	52360

CONTINUED

FRACTIONAL Hi-PerCarb

Series 135 5D Fractional	Hardness	Vc (sfm)	Diameter (D ₁) (inch)								
			1/32	1/8	1/4	3/8	1/2	5/8	7/8		
P CARBON STEELS 1018, 1040, 1080, 1090, 10L50, 1140, 1212, 12L15, 1525, 1536	≤ 175 Bhn or ≤ 7 HRc	345	RPM	42173	10543	5272	3514	2636	2109	1506	
		(276-414)	Fr	0.0010	0.0040	0.0080	0.0120	0.0159	0.0199	0.0279	
			Feed (ipm)	42.0	42.0	42.0	42.0	42.0	42.0	42.0	
	≤ 275 Bhn or ≤ 28 HRc	310	RPM	37894	9474	4737	3158	2368	1895	1353	
		(248-372)	Fr	0.0009	0.0036	0.0072	0.0108	0.0144	0.0179	0.0251	
			Feed (ipm)	34.0	34.0	34.0	34.0	34.0	34.0	34.0	
	≤ 425 Bhn or ≤ 45 HRc	180	RPM	22003	5501	2750	1834	1375	1100	786	
		(144-216)	Fr	0.0007	0.0030	0.0060	0.0090	0.0120	0.0150	0.0210	
			Feed (ipm)	16.5	16.5	16.5	16.5	16.5	16.5	16.5	
	H ALLOY STEELS 4140, 4150, 4320, 5120, 5150, 8630, 86L20, 50100	≤ 275 Bhn or ≤ 28 HRc	270	RPM	33005	8251	4126	2750	2063	1650	1179
			(216-324)	Fr	0.0008	0.0030	0.0061	0.0091	0.0121	0.0151	0.0212
				Feed (ipm)	25.0	25.0	25.0	25.0	25.0	25.0	25.0
≤ 375 Bhn or ≤ 40 HRc		165	RPM	20170	5042	2521	1681	1261	1008	720	
		(132-198)	Fr	0.0006	0.0026	0.0052	0.0077	0.0103	0.0129	0.0180	
			Feed (ipm)	13.0	13.0	13.0	13.0	13.0	13.0	13.0	
≤ 450 Bhn or ≤ 48 HRc		115	RPM	14058	3514	1757	1171	879	703	502	
		(92-138)	Fr	0.0004	0.0018	0.0035	0.0053	0.0071	0.0088	0.0123	
			Feed (ipm)	6.2	6.2	6.2	6.2	6.2	6.2	6.2	
K TOOL STEELS A2, D2, H13, L2, M2, P20, S7, T15, W2		≤ 200 Bhn or ≤ 13 HRc	120	RPM	14669	3667	1834	1222	917	733	524
			(96-144)	Fr	0.0006	0.0026	0.0051	0.0077	0.0103	0.0128	0.0179
				Feed (ipm)	9.4	9.4	9.4	9.4	9.4	9.4	9.4
	≤ 375 Bhn or ≤ 40 HRc	80	RPM	9779	2445	1222	815	611	489	349	
		(64-96)	Fr	0.0003	0.0012	0.0024	0.0036	0.0047	0.0059	0.0083	
			Feed (ipm)	2.9	2.9	2.9	2.9	2.9	2.9	2.9	
	≤ 475 Bhn or ≤ 50 HRc	70	RPM	8557	2139	1070	713	535	428	306	
		(56-84)	Fr	0.0002	0.0008	0.0016	0.0024	0.0032	0.0040	0.0056	
			Feed (ipm)	1.7	1.7	1.7	1.7	1.7	1.7	1.7	
	M CAST IRONS Gray, Malleable, Ductile	≤ 220 Bhn or ≤ 19 HRc	300	RPM	36672	9168	4584	3056	2292	1834	1310
			(240-360)	Fr	0.0011	0.0045	0.0089	0.0134	0.0179	0.0224	0.0313
				Feed (ipm)	41.0	41.0	41.0	41.0	41.0	41.0	41.0
≤ 260 Bhn or ≤ 26 HRc		265	RPM	32394	8098	4049	2699	2025	1620	1157	
		(212-318)	Fr	0.0011	0.0046	0.0091	0.0137	0.0183	0.0228	0.0320	
			Feed (ipm)	37.0	37.0	37.0	37.0	37.0	37.0	37.0	
M STAINLESS STEELS (FREE MACHINING) 303, 416, 420F, 430F, 440F		≤ 185 Bhn or ≤ 9 HRc	250	RPM	30560	7640	3820	2547	1910	1528	1091
			(200-300)	Fr	0.0006	0.0026	0.0051	0.0077	0.0102	0.0128	0.0179
				Feed (ipm)	19.5	19.5	19.5	19.5	19.5	19.5	19.5
		≤ 275 Bhn or ≤ 28 HRc	150	RPM	18336	4584	2292	1528	1146	917	655
			(120-180)	Fr	0.0005	0.0020	0.0039	0.0059	0.0079	0.0098	0.0137
				Feed (ipm)	9.0	9.0	9.0	9.0	9.0	9.0	9.0
	M STAINLESS STEELS (DIFFICULT) 304, 316, 321, 13-8 PH, 15-5PH, 17-4 PH, Custom 450	≤ 275 Bhn or ≤ 28 HRc	80	RPM	9779	2445	1222	815	611	489	349
			(64-96)	Fr	0.0005	0.0020	0.0039	0.0059	0.0079	0.0098	0.0137
				Feed (ipm)	4.8	4.8	4.8	4.8	4.8	4.8	4.8
		≤ 375 Bhn or ≤ 40 HRc	55	RPM	6723	1681	840	560	420	336	240
			(44-66)	Fr	0.0004	0.0018	0.0036	0.0054	0.0071	0.0089	0.0125
				Feed (ipm)	3.0	3.0	3.0	3.0	3.0	3.0	3.0

continued on next page

Series 135 5D Fractional	Hardness	Vc (sfm)	Diameter (D ₁) (inch)								
			1/32	1/8	1/4	3/8	1/2	5/8	7/8		
S SUPER ALLOYS (Nickel , Cobalt, Iron Base) Inconel 601, 617, 625, Incoloy, Monel 400, Rene, Waspaloy	≤ 300 Bhn or ≤ 32 HRc	40	RPM	4890	1222	611	407	306	244	175	
		(32-48)	Fr	0.0002	0.0008	0.0016	0.0025	0.0033	0.0041	0.0057	
			Feed (ipm)	1.0	1.0	1.0	1.0	1.0	1.0	1.0	
	≤ 400 Bhn or ≤ 43 HRc	20	RPM	2445	611	306	204	153	122	87	
		(16-24)	Fr	0.0002	0.0007	0.0013	0.0020	0.0026	0.0033	0.0046	
			Feed (ipm)	0.4	0.4	0.4	0.4	0.4	0.4	0.4	
	TITANIUM ALLOYS Pure Titanium, Ti6Al4V, Ti6Al2Sn4Zr2Mo, Ti4Al4Mo2Sn0.5Si, Ti-6Al4V	≤ 275 Bhn or ≤ 28 HRc	105	RPM	12835	3209	1604	1070	802	642	458
			(84-126)	Fr	0.0005	0.0018	0.0036	0.0054	0.0072	0.0090	0.0127
				Feed (ipm)	5.8	5.8	5.8	5.8	5.8	5.8	5.8
		≤ 350 Bhn or ≤ 38 HRc	80	RPM	9779	2445	1222	815	611	489	349
			(64-96)	Fr	0.0004	0.0016	0.0032	0.0048	0.0064	0.0080	0.0112
				Feed (ipm)	3.9	3.9	3.9	3.9	3.9	3.9	3.9
≤ 440 Bhn or ≤ 47 HRc		42	RPM	5134	1284	642	428	321	257	183	
		(34-50)	Fr	0.0003	0.0012	0.0025	0.0037	0.0050	0.0062	0.0087	
			Feed (ipm)	1.6	1.6	1.6	1.6	1.6	1.6	1.6	
N ALUMINUM ALLOYS 2017, 2024, 356, 6061, 7075		≤ 80 Bhn or ≤ 47 HRb	635	RPM	77622	19406	9703	6469	4851	3881	2772
			(508-762)	Fr	0.0012	0.0049	0.0099	0.0148	0.0198	0.0247	0.0346
				Feed (ipm)	96.0	96.0	96.0	96.0	96.0	96.0	96.0
	≤ 150 Bhn or ≤ 7 HRc	540	RPM	66010	16502	8251	5501	4126	3300	2357	
		(432-648)	Fr	0.0012	0.0050	0.0099	0.0149	0.0199	0.0248	0.0348	
			Feed (ipm)	82.0	82.0	82.0	82.0	82.0	82.0	82.0	
	COPPER ALLOYS Alum Bronze, C110, Muntz Brass	≤ 140 Bhn or ≤ 3 HRc	450	RPM	55008	13752	6876	4584	3438	2750	1965
			(360-540)	Fr	0.0005	0.0020	0.0040	0.0060	0.0080	0.0100	0.0140
				Feed (ipm)	27.5	27.5	27.5	27.5	27.5	27.5	27.5
		≤ 200 Bhn or ≤ 23 HRc	360	RPM	44006	11002	5501	3667	2750	2200	1572
			(288-432)	Fr	0.0005	0.0020	0.0040	0.0060	0.0080	0.0100	0.0140
				Feed (ipm)	22.0	22.0	22.0	22.0	22.0	22.0	22.0

Bhn (Brinell) HRc (Rockwell C) HRb (Rockwell B)

$rpm = Vc \times 3.82 / D_1$

$ipm = Fr \times rpm$

reduce speed and feed for materials harder than listed

refer to the KYOCERA SGS Tool Wizard® for complete technical information (www.kyocera-sgstool.com)

Hi-PerCarb

Series 135M 5D Metric	Hardness	Vc (m/min)	Diameter (D ₁) (mm)									
			1.5	3	6	8	10	12	16	20		
P CARBON STEELS 1018, 1040, 1080, 1090, 10L50, 1140, 1212, 12L15, 1525, 1536	≤ 175 Bhn or ≤ 7 HRc	105	RPM	22297	11148	5574	4181	3344	2787	2090	1672	
		(84-126)	Fr	0.048	0.095	0.190	0.254	0.317	0.380	0.507	0.634	
			Feed (mm/min)	1060	1060	1060	1060	1060	1060	1060	1060	
	≤ 275 Bhn or ≤ 28 HRc	94	RPM	20035	10017	5009	3756	3005	2504	1878	1503	
		(76-113)	Fr	0.043	0.085	0.171	0.228	0.285	0.341	0.455	0.569	
			Feed (mm/min)	855	855	855	855	855	855	855	855	
	≤ 425 Bhn or ≤ 45 HRc	55	RPM	11633	5816	2908	2181	1745	1454	1091	872	
		(44-66)	Fr	0.036	0.071	0.143	0.190	0.238	0.285	0.381	0.476	
			Feed (mm/min)	415	415	415	415	415	415	415	415	
	H ALLOY STEELS 4140, 4150, 4320, 5120, 5150, 8630, 86L20, 50100	≤ 275 Bhn or ≤ 28 HRc	82	RPM	17449	8725	4362	3272	2617	2181	1636	1309
			(66-99)	Fr	0.036	0.072	0.143	0.191	0.239	0.287	0.382	0.478
				Feed (mm/min)	625	625	625	625	625	625	625	625
≤ 375 Bhn or ≤ 40 HRc		50	RPM	10664	5332	2666	1999	1600	1333	1000	800	
		(40-60)	Fr	0.031	0.062	0.124	0.165	0.206	0.248	0.330	0.413	
			Feed (mm/min)	330	330	330	330	330	330	330	330	
≤ 450 Bhn or ≤ 48 HRc		35	RPM	7432	3716	1858	1394	1115	929	697	557	
		(28-42)	Fr	0.022	0.043	0.086	0.115	0.144	0.172	0.230	0.287	
			Feed (mm/min)	160	160	160	160	160	160	160	160	
K TOOL STEELS A2, D2, H13, L2, M2, P20, S7, T15, W2		≤ 200 Bhn or ≤ 13 HRc	37	RPM	7755	3878	1939	1454	1163	969	727	582
			(29-44)	Fr	0.031	0.062	0.124	0.165	0.206	0.248	0.330	0.413
				Feed (mm/min)	240	240	240	240	240	240	240	240
	≤ 375 Bhn or ≤ 40 HRc	24	RPM	5170	2585	1293	969	776	646	485	388	
		(20-29)	Fr	0.015	0.029	0.058	0.077	0.097	0.116	0.155	0.193	
			Feed (mm/min)	75	75	75	75	75	75	75	75	
	≤ 475 Bhn or ≤ 50 HRc	21	RPM	4524	2262	1131	848	679	565	424	339	
		(17-26)	Fr	0.010	0.020	0.040	0.053	0.066	0.080	0.106	0.133	
			Feed (mm/min)	45	45	45	45	45	45	45	45	
	M CAST IRONS Gray, Malleable, Ductile	≤ 220 Bhn or ≤ 19 HRc	91	RPM	19388	9694	4847	3635	2908	2424	1818	1454
			(73-110)	Fr	0.054	0.108	0.217	0.289	0.361	0.433	0.578	0.722
				Feed (mm/min)	1050	1050	1050	1050	1050	1050	1050	1050
≤ 260 Bhn or ≤ 26 HRc		81	RPM	17126	8563	4282	3211	2569	2141	1606	1284	
		(65-97)	Fr	0.055	0.109	0.218	0.291	0.364	0.437	0.582	0.728	
			Feed (mm/min)	935	935	935	935	935	935	935	935	
M STAINLESS STEELS (FREE MACHINING) 303, 416, 420F, 430F, 440F	≤ 185 Bhn or ≤ 9 HRc	76	RPM	16157	8078	4039	3029	2424	2020	1515	1212	
		(61-91)	Fr	0.031	0.061	0.123	0.163	0.204	0.245	0.327	0.408	
			Feed (mm/min)	495	495	495	495	495	495	495	495	
	≤ 275 Bhn or ≤ 28 HRc	46	RPM	9694	4847	2424	1818	1454	1212	909	727	
		(37-55)	Fr	0.024	0.047	0.095	0.127	0.158	0.190	0.253	0.316	
			Feed (mm/min)	230	230	230	230	230	230	230	230	
	M STAINLESS STEELS (DIFFICULT) 304, 316, 321, 13-8 PH, 15-5PH, 17-4 PH, Custom 450	≤ 275 Bhn or ≤ 28 HRc	24	RPM	5170	2585	1293	969	776	646	485	388
			(20-29)	Fr	0.023	0.046	0.093	0.124	0.155	0.186	0.248	0.309
				Feed (mm/min)	120	120	120	120	120	120	120	120
		≤ 375 Bhn or ≤ 40 HRc	17	RPM	3555	1777	889	666	533	444	333	267
			(13-20)	Fr	0.021	0.042	0.084	0.113	0.141	0.169	0.225	0.281
				Feed (mm/min)	75	75	75	75	75	75	75	75

continued on next page

Series 135M 5D Metric	Hardness	Vc (m/min)	Diameter (D ₁) (mm)									
			1.5	3	6	8	10	12	16	20		
SUPER ALLOYS (Nickel, Cobalt, Iron Base) Inconel 601, 617, 625, Incoloy, Monel 400, Rene, Waspaloy	≤ 300 Bhn or ≤ 32 HRc	12	RPM	2585	1293	646	485	388	323	242	194	
		(10-15)	Fr	0.010	0.019	0.039	0.052	0.064	0.077	0.103	0.129	
			Feed (mm/min)	25	25	25	25	25	25	25	25	
	≤ 400 Bhn or ≤ 43 HRc	6	RPM	1293	646	323	242	194	162	121	97	
		(5-7)	Fr	0.007	0.014	0.028	0.037	0.046	0.056	0.074	0.093	
			Feed (mm/min)	9	9	9	9	9	9	9	9	
	TITANIUM ALLOYS Pure Titanium, Ti6Al4V, Ti6Al2Sn4Zr2Mo, Ti4Al4Mo2Sn0.5Si, Ti-6Al4V	≤ 275 Bhn or ≤ 28 HRc	32	RPM	6786	3393	1696	1272	1018	848	636	509
			(26-38)	Fr	0.021	0.043	0.085	0.114	0.142	0.171	0.228	0.285
				Feed (mm/min)	145	145	145	145	145	145	145	145
		≤ 350 Bhn or ≤ 38 HRc	24	RPM	5170	2585	1293	969	776	646	485	388
			(20-29)	Fr	0.019	0.039	0.077	0.103	0.129	0.155	0.206	0.258
				Feed (mm/min)	100	100	100	100	100	100	100	100
≤ 440 Bhn or ≤ 47 HRc		13	RPM	2714	1357	679	509	407	339	254	204	
		(10-15)	Fr	0.015	0.029	0.059	0.079	0.098	0.118	0.157	0.196	
			Feed (mm/min)	40	40	40	40	40	40	40	40	
ALUMINUM ALLOYS 2017, 2024, 356, 6061, 7075		≤ 80 Bhn or ≤ 47 HRb	194	RPM	41039	20519	10260	7695	6156	5130	3847	3078
			(155-232)	Fr	0.059	0.118	0.237	0.316	0.395	0.474	0.632	0.790
				Feed (mm/min)	2430	2430	2430	2430	2430	2430	2430	2430
	≤ 150 Bhn or ≤ 7 HRc	165	RPM	34899	17449	8725	6544	5235	4362	3272	2617	
		(132-198)	Fr	0.059	0.118	0.237	0.316	0.394	0.473	0.631	0.789	
			Feed (mm/min)	2065	2065	2065	2065	2065	2065	2065	2065	
	Copper Alloys Alum Bronze, C110, Muntz Brass	≤ 140 Bhn or ≤ 3 HRc	137	RPM	29082	14541	7271	5453	4362	3635	2726	2181
			(110-165)	Fr	0.027	0.053	0.107	0.142	0.178	0.213	0.284	0.355
				Feed (mm/min)	775	775	775	775	775	775	775	775
		≤ 200 Bhn or ≤ 23 HRc	110	RPM	23266	11633	5816	4362	3490	2908	2181	1745
			(88-132)	Fr	0.027	0.054	0.108	0.144	0.181	0.217	0.289	0.361
				Feed (mm/min)	630	630	630	630	630	630	630	630

Bhn (Brinell) HRc (Rockwell C) HRb (Rockwell B)
 $rpm = (Vc \times 1000) / (D_1 \times 3.14)$
 $mm/min = Fr \times rpm$
 reduce speed and feed for materials harder than listed
 refer to the KYOCERA SGS Tool Wizard® for complete technical information (www.kyocera-sgstool.com)

Hi-PerCarb



3xD



131N 3xD

FRACTIONAL & METRIC SERIES

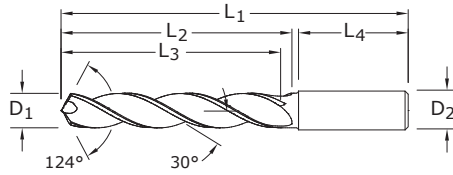

- Triple margin design improves hole stability and size control while providing superior finish, roundness and cylindricity
- Self-stabilizing pyramid point design stabilizes the drill on contact with the workpiece
- Open flute structure efficiently transports chips while maintaining strength at high feed rates
- Sculpted gash allows chips to easily flow away from the drill center
- Recommended for materials ≤ 175 Bhn (≤ 16 HRC)

CUTTING DIA.	DECIMAL EQUIV.	METRIC EQUIV.	TAP SIZE REFERENCE ONLY	SHANK DIA.	OVERALL LENGTH	FLUTE LENGTH	CLEARED LENGTH	SHANK LENGTH	UNCOATED	Ti-NAMITE-B (TiB ₂)
D ₁				D ₂	L ₁	L ₂	L ₃	L ₄	EDP NO.	EDP NO.
3,0 mm	0.1181			6,0	62,0	20,0	14,0	36,0	64600	67600
3,1 mm	0.1220			6,0	62,0	20,0	14,0	36,0	64601	67601
1/8	0.1250	3.18		6,0	62,0	20,0	14,0	36,0	54600	54700
3,2 mm	0.1260		M3,5 X 0,35	6,0	62,0	20,0	14,0	36,0	64602	67602
3,3 mm	0.1299		M4 X 0,7	6,0	62,0	20,0	14,0	36,0	64603	67603
3,4 mm	0.1339			6,0	62,0	20,0	14,0	36,0	64604	67604
#29	0.1360	3.45	8-32,8-36	6,0	62,0	20,0	14,0	36,0	54601	54701
3,5 mm	0.1378		M4 X 0,5	6,0	62,0	20,0	14,0	36,0	64605	67605
9/64	0.1406	3.57		6,0	62,0	20,0	14,0	36,0	54602	54702
3,6 mm	0.1417		M4 X 0,35	6,0	62,0	20,0	14,0	36,0	64606	67606
3,7 mm	0.1457		M4,5 X 0,75	6,0	62,0	20,0	14,0	36,0	64607	67607
3,8 mm	0.1496		10-24	6,0	66,0	24,0	17,0	36,0	64608	67608
3,9 mm	0.1535			6,0	66,0	24,0	17,0	36,0	64609	67609
5/32	0.1562	3.97		6,0	66,0	24,0	17,0	36,0	54603	54703
4,0 mm	0.1575		M4,5 X 0,5	6,0	66,0	24,0	17,0	36,0	64610	67610
#21	0.1590	4.04	10-32	6,0	66,0	24,0	17,0	36,0	54604	54704
4,1 mm	0.1614			6,0	66,0	24,0	17,0	36,0	64611	67611
4,2 mm	0.1654		M5 / M5 x 0,75	6,0	66,0	24,0	17,0	36,0	64612	67612
4,3 mm	0.1693			6,0	66,0	24,0	17,0	36,0	64613	67613
11/64	0.1719	4.37		6,0	66,0	24,0	17,0	36,0	54605	54705
4,4 mm	0.1732		12-24	6,0	66,0	24,0	17,0	36,0	64614	67614
4,5 mm	0.1772		M5 X 0,5	6,0	66,0	24,0	17,0	36,0	64615	67615
4,6 mm	0.1811		12-28	6,0	66,0	24,0	17,0	36,0	64616	67616
4,7 mm	0.1850		12-32	6,0	66,0	24,0	17,0	36,0	64617	67617
3/16	0.1875	4.76		6,0	66,0	28,0	20,0	36,0	54606	54706
4,8 mm	0.1890		7/32-32	6,0	66,0	28,0	20,0	36,0	64618	67618
4,9 mm	0.1929			6,0	66,0	28,0	20,0	36,0	64619	67619
5,0 mm	0.1969		M6 X 1	6,0	66,0	28,0	20,0	36,0	64620	67620
5,1 mm	0.2008		1/4-20	6,0	66,0	28,0	20,0	36,0	64621	67621
13/64	0.2031	5.16		6,0	66,0	28,0	20,0	36,0	54607	54707
5,2 mm	0.2047		M6 X 0,75	6,0	66,0	28,0	20,0	36,0	64622	67622
5,3 mm	0.2087			6,0	66,0	28,0	20,0	36,0	64623	67623
5,4 mm	0.2126			6,0	66,0	28,0	20,0	36,0	64624	67624
5,5 mm	0.2165		M6 X 0,5	6,0	66,0	28,0	20,0	36,0	64625	67625
7/32	0.2188	5.56	1/4-32	6,0	66,0	28,0	20,0	36,0	54608	54708
5,6 mm	0.2205			6,0	66,0	28,0	20,0	36,0	64626	67626

TOLERANCES (inch)

- ≤.1181 DIAMETER**
D₁ = +.0008/+0.0047
D₂ = h₆
- >.1181-.2362 DIAMETER**
D₁ = +.00016/+0.00063
D₂ = h₆
- >.2362-.3937 DIAMETER**
D₁ = +.00024/+0.00083
D₂ = h₆
- >.3937-.7087 DIAMETER**
D₁ = +.00028/+0.00098
D₂ = h₆
- >.7087-1.1811 DIAMETER**
D₁ = +.00031/+0.0114
D₂ = h₆

TOLERANCES (mm)

- ≤3 DIAMETER**
D₁ = +0,002/+0,012
D₂ = h₆
- >3-6 DIAMETER**
D₁ = +0,004/+0,016
D₂ = h₆
- >6-10 DIAMETER**
D₁ = +0,006/+0,021
D₂ = h₆
- >10-18 DIAMETER**
D₁ = +0,007/+0,025
D₂ = h₆

- NON-FERROUS
- PLASTICS/COMPOSITES

For patent information visit www.ksptpatents.com

continued on next page

131N 3xD
FRACTIONAL & METRIC SERIES

CUTTING DIA.	DECIMAL EQUIV.	METRIC EQUIV.	TAP SIZE REFERENCE ONLY	SHANK DIA.	OVERALL LENGTH	FLUTE LENGTH	CLEARED LENGTH	SHANK LENGTH	UNCOATED	Ti-NAMITE-B (TiB ₂)
D ₁				D ₂	L ₁	L ₂	L ₃	L ₄	EDP NO.	EDP NO.
5,7 mm	0.2244			6,0	66,0	28,0	20,0	36,0	64627	67627
5,8 mm	0.2283			6,0	66,0	28,0	20,0	36,0	64628	67628
5,9 mm	0.2323			6,0	66,0	28,0	20,0	36,0	64629	67629
15/64	0.2344	5.95		6,0	66,0	28,0	20,0	36,0	54609	54709
6,0 mm	0.2362		M7 X 1	6,0	66,0	28,0	20,0	36,0	64630	67630
6,1 mm	0.2402			8,0	79,0	34,0	24,0	36,0	64631	67631
6,2 mm	0.2441		M7 X 0,75	8,0	79,0	34,0	24,0	36,0	64632	67632
6,3 mm	0.2480			8,0	79,0	34,0	24,0	36,0	64633	67633
1/4	0.2500	6.35		8,0	79,0	34,0	24,0	36,0	54610	54710
6,4 mm	0.2520			8,0	79,0	34,0	24,0	36,0	64634	67634
6,5 mm	0.2559			8,0	79,0	34,0	24,0	36,0	64635	67635
F	0.2570	6.53	5/16-18	8,0	79,0	34,0	24,0	36,0	54611	54711
6,6 mm	0.2598			8,0	79,0	34,0	24,0	36,0	64636	67636
6,7 mm	0.2638			8,0	79,0	34,0	24,0	36,0	64637	67637
17/64	0.2656	6.75	5/16-20	8,0	79,0	34,0	24,0	36,0	54612	54712
6,8 mm	0.2677		M8 X 1,25	8,0	79,0	34,0	24,0	36,0	64638	67638
6,9 mm	0.2717		5/16-24	8,0	79,0	34,0	24,0	36,0	64639	67639
7,0 mm	0.2756		M8 X 1	8,0	79,0	34,0	24,0	36,0	64640	67640
7,1 mm	0.2795			8,0	79,0	41,0	29,0	36,0	64641	67641
9/32	0.2812	7.14	5/16-32	8,0	79,0	41,0	29,0	36,0	54613	54713
7,2 mm	0.2835		M8 X 0,75	8,0	79,0	41,0	29,0	36,0	64642	67642
7,3 mm	0.2874			8,0	79,0	41,0	29,0	36,0	64643	67643
7,4 mm	0.2913			8,0	79,0	41,0	29,0	36,0	64644	67644
7,5 mm	0.2953		M8 X 0,5	8,0	79,0	41,0	29,0	36,0	64645	67645
19/64	0.2969	7.54		8,0	79,0	41,0	29,0	36,0	54614	54714
7,6 mm	0.2992			8,0	79,0	41,0	29,0	36,0	64646	67646
7,7 mm	0.3031			8,0	79,0	41,0	29,0	36,0	64647	67647
7,8 mm	0.3071		M9 X 1,25	8,0	79,0	41,0	29,0	36,0	64648	67648
7,9 mm	0.3110			8,0	79,0	41,0	29,0	36,0	64649	67649
5/16	0.3125	7.94	3/8-16	8,0	79,0	41,0	29,0	36,0	54615	54715
8,0 mm	0.3150		M9 X 1	8,0	79,0	41,0	29,0	36,0	64650	67650
8,1 mm	0.3189			10,0	89,0	47,0	35,0	40,0	64651	67651
8,2 mm	0.3228			10,0	89,0	47,0	35,0	40,0	64652	67652
8,3 mm	0.3268			10,0	89,0	47,0	35,0	40,0	64653	67653
21/64	0.3281	8.33	3/8-20	10,0	89,0	47,0	35,0	40,0	54616	54716
8,4 mm	0.3307			10,0	89,0	47,0	35,0	40,0	64654	67654
Q	0.3320	8.43	3/8-24	10,0	89,0	47,0	35,0	40,0	54617	54717
8,5 mm	0.3346		M10 X 1,5	10,0	89,0	47,0	35,0	40,0	64655	67655
8,6 mm	0.3386			10,0	89,0	47,0	35,0	40,0	64656	67656
8,7 mm	0.3425			10,0	89,0	47,0	35,0	40,0	64657	67657
11/32	0.3438	8.73	3/8-32	10,0	89,0	47,0	35,0	40,0	54618	54718
8,8 mm	0.3465		M10 X 1,25	10,0	89,0	47,0	35,0	40,0	64658	67658
8,9 mm	0.3504			10,0	89,0	47,0	35,0	40,0	64659	67659
9,0 mm	0.3543		M10 X 1	10,0	89,0	47,0	35,0	40,0	64660	67660
9,1 mm	0.3583			10,0	89,0	47,0	35,0	40,0	64661	67661
23/64	0.3594	9.13		10,0	89,0	47,0	35,0	40,0	54619	54719

continued on next page

CONTINUED

Hi-PerCarb



3xD



131N 3xD

FRACTIONAL & METRIC SERIES

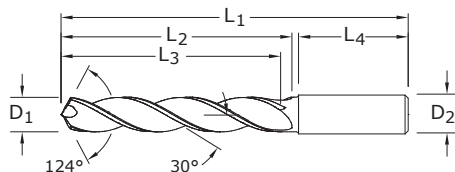

- Triple margin design improves hole stability and size control while providing superior finish, roundness and cylindricity
- Self-stabilizing pyramid point design stabilizes the drill on contact with the workpiece
- Open flute structure efficiently transports chips while maintaining strength at high feed rates
- Sculpted gash allows chips to easily flow away from the drill center
- Recommended for materials ≤ 175 Bhn (≤ 16 HRC)

CUTTING DIA.	DECIMAL EQUIV.	METRIC EQUIV.	TAP SIZE REFERENCE ONLY	SHANK DIA.	OVERALL LENGTH	FLUTE LENGTH	CLEARED LENGTH	SHANK LENGTH	UNCOATED	Ti-NAMITE-B (TiB ₂)
D ₁				D ₂	L ₁	L ₂	L ₃	L ₄	EDP NO.	EDP NO.
9,2 mm	0.3622		M10 X 0,75	10,0	89,0	47,0	35,0	40,0	64662	67662
9,3 mm	0.3661			10,0	89,0	47,0	35,0	40,0	64663	67663
U	0.3680	9.35	7/16-14	10,0	89,0	47,0	35,0	40,0	54620	54720
9,4 mm	0.3701			10,0	89,0	47,0	35,0	40,0	64664	67664
9,5 mm	0.3740		M11 / M10 X 0,5	10,0	89,0	47,0	35,0	40,0	64665	67665
3/8	0.3750	9.53		10,0	89,0	47,0	35,0	40,0	54621	54721
9,6 mm	0.3780			10,0	89,0	47,0	35,0	40,0	64666	67666
9,7 mm	0.3819			10,0	89,0	47,0	35,0	40,0	64667	67667
9,8 mm	0.3858			10,0	89,0	47,0	35,0	40,0	64668	67668
9,9 mm	0.3898			10,0	89,0	47,0	35,0	40,0	64669	67669
25/64	0.3906	9.92	7/16-20	10,0	89,0	47,0	35,0	40,0	54622	54722
10,0 mm	0.3937			10,0	89,0	47,0	35,0	40,0	64670	67670
10,1 mm	0.3976			12,0	102,0	55,0	40,0	45,0	64671	67671
10,2 mm	0.4016		M12 X 1,75	12,0	102,0	55,0	40,0	45,0	64672	67672
10,3 mm	0.4055			12,0	102,0	55,0	40,0	45,0	64673	67673
13/32	0.4062	10.32		12,0	102,0	55,0	40,0	45,0	54623	54723
10,4 mm	0.4094			12,0	102,0	55,0	40,0	45,0	64674	67674
10,5 mm	0.4134		M12 X 1,5	12,0	102,0	55,0	40,0	45,0	64675	67675
10,6 mm	0.4173			12,0	102,0	55,0	40,0	45,0	64676	67676
10,7 mm	0.4213			12,0	102,0	55,0	40,0	45,0	64677	67677
27/64	0.4219	10.72	1/2-13	12,0	102,0	55,0	40,0	45,0	54624	54724
10,8 mm	0.4252		M12 X 1,25	12,0	102,0	55,0	40,0	45,0	64678	67678
10,9 mm	0.4291			12,0	102,0	55,0	40,0	45,0	64679	67679
11,0 mm	0.4331		M12 X 1	12,0	102,0	55,0	40,0	45,0	64680	67680
11,1 mm	0.4370			12,0	102,0	55,0	40,0	45,0	64681	67681
7/16	0.4375	11.11	1/4-18NPT	12,0	102,0	55,0	40,0	45,0	54625	54725
11,2 mm	0.4409			12,0	102,0	55,0	40,0	45,0	64682	67682
11,3 mm	0.4449			12,0	102,0	55,0	40,0	45,0	64683	67683
11,4 mm	0.4488			12,0	102,0	55,0	40,0	45,0	64684	67684
11,5 mm	0.4528		M12 X 0,5	12,0	102,0	55,0	40,0	45,0	64685	67685
11,6 mm	0.4567			12,0	102,0	55,0	40,0	45,0	64686	67686
11,7 mm	0.4606			12,0	102,0	55,0	40,0	45,0	64687	67687
11,8 mm	0.4646			12,0	102,0	55,0	40,0	45,0	64688	67688
11,9 mm	0.4685			12,0	102,0	55,0	40,0	45,0	64689	67689
15/32	0.4688	11.91	1/2-28	12,0	102,0	55,0	40,0	45,0	54626	54726
12,0 mm	0.4724		M14 X 2	12,0	102,0	55,0	40,0	45,0	64690	67690

TOLERANCES (inch)

- ≤.1181 DIAMETER
D₁ = +.0008/+0.0047
D₂ = h₆
- >.1181-.2362 DIAMETER
D₁ = +.00016/+0.00063
D₂ = h₆
- >.2362-.3937 DIAMETER
D₁ = +.00024/+0.00083
D₂ = h₆
- >.3937-.7087 DIAMETER
D₁ = +.00028/+0.00098
D₂ = h₆
- >.7087-1.1811 DIAMETER
D₁ = +.00031/+0.00114
D₂ = h₆

TOLERANCES (mm)

- ≤3 DIAMETER
D₁ = +0,002/+0,012
D₂ = h₆
- >3-6 DIAMETER
D₁ = +0,004/+0,016
D₂ = h₆
- >6-10 DIAMETER
D₁ = +0,006/+0,021
D₂ = h₆
- >10-18 DIAMETER
D₁ = +0,007/+0,025
D₂ = h₆

- NON-FERROUS
- PLASTICS/COMPOSITES

For patent information visit www.ksptpatents.com

continued on next page



131N 3xD
 FRACTIONAL & METRIC SERIES

CUTTING DIA.	DECIMAL EQUIV.	METRIC EQUIV.	TAP SIZE REFERENCE ONLY	SHANK DIA.	OVERALL LENGTH	FLUTE LENGTH	CLEARED LENGTH	SHANK LENGTH	UNCOATED	Ti-NAMITE-B (TiB ₂)
D ₁				D ₂	L ₁	L ₂	L ₃	L ₄	EDP NO.	EDP NO.
31/64	0.4844	12.30	9/16-12	14,0	107,0	60,0	43,0	45,0	54627	54727
12,5 mm	0.4921		M14 X 1,5	14,0	107,0	60,0	43,0	45,0	64691	67691
1/2	0.5000	12.70		14,0	107,0	60,0	43,0	45,0	54628	54728
12,8 mm	0.5039		M14 X 1,25	14,0	107,0	60,0	43,0	45,0	64692	67692
13,0 mm	0.5118		M14 X 1	14,0	107,0	60,0	43,0	45,0	64693	67693
33/64	0.5156	13.10	9/16-18	14,0	107,0	60,0	43,0	45,0	54629	54729
13,5 mm	0.5315		5/8-11	14,0	107,0	60,0	43,0	45,0	64694	67694
13,8 mm	0.5433			14,0	107,0	60,0	43,0	45,0	64695	67695
14,0 mm	0.5512		M16 X 2	14,0	107,0	60,0	43,0	45,0	64696	67696
9/16	0.5625	14.29		16,0	115,0	65,0	45,0	48,0	54630	54730
14,5 mm	0.5709		M16 X 1,5	16,0	115,0	65,0	45,0	48,0	64697	67697
37/64	0.5781	14.68	5/8-18	16,0	115,0	65,0	45,0	48,0	54631	54731
14,8 mm	0.5827			16,0	115,0	65,0	45,0	48,0	64698	67698
15,0 mm	0.5906		M16 X 1	16,0	115,0	65,0	45,0	48,0	64699	67699
15,5 mm	0.6102		M18 X 2,5	16,0	115,0	65,0	45,0	48,0	64700	67700
15,8 mm	0.6220			16,0	115,0	65,0	45,0	48,0	64701	67701
5/8	0.6250	15.88	11/16-16	16,0	115,0	65,0	45,0	48,0	54632	54732
16,0 mm	0.6299			16,0	115,0	65,0	45,0	48,0	64702	67702
21/32	0.6562	16.67	3/4-10	18,0	123,0	73,0	51,0	48,0	54633	54733
11/16	0.6875	17.46	3/4-16	18,0	123,0	73,0	51,0	48,0	54634	54734
3/4	0.7500	19.05	13/16-16	20,0	131,0	79,0	55,0	50,0	54635	54735

CONTINUED

Hi-PerCarb



5xD



131N 5xD

FRACTIONAL & METRIC SERIES

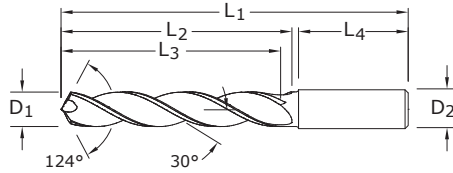

- Triple margin design improves hole stability and size control while providing superior finish, roundness and cylindricity
- Self-stabilizing pyramid point design stabilizes the drill on contact with the workpiece
- Open flute structure efficiently transports chips while maintaining strength at high feed rates
- Sculpted gash allows chips to easily flow away from the drill center
- Recommended for materials ≤ 175 Bhn (≤ 16 HRC)

CUTTING DIA.	DECIMAL EQUIV.	METRIC EQUIV.	TAP SIZE REFERENCE ONLY	SHANK DIA.	OVERALL LENGTH	FLUTE LENGTH	CLEARED LENGTH	SHANK LENGTH	UNCOATED	Ti-NAMITE-B (TiB ₂)
D ₁				D ₂	L ₁	L ₂	L ₃	L ₄	EDP NO.	EDP NO.
3,0 mm	0.1181			6,0	66,0	28,0	23,0	36,0	65000	64800
3,1 mm	0.1220			6,0	66,0	28,0	23,0	36,0	65001	64801
1/8	0.1250	3.18		6,0	66,0	28,0	23,0	36,0	55000	54800
3,2 mm	0.1260		M3,5 X 0,35	6,0	66,0	28,0	23,0	36,0	65002	64802
3,3 mm	0.1299		M4 X 0,7	6,0	66,0	28,0	23,0	36,0	65003	64803
3,4 mm	0.1339			6,0	66,0	28,0	23,0	36,0	65004	64804
#29	0.1360	3.45	8-32,8-36	6,0	66,0	28,0	23,0	36,0	55001	54801
3,5 mm	0.1378		M4 X 0,5	6,0	66,0	28,0	23,0	36,0	65005	64805
9/64	0.1406	3.57		6,0	66,0	28,0	23,0	36,0	55002	54802
3,6 mm	0.1417		M4 X 0,35	6,0	66,0	28,0	23,0	36,0	65006	64806
3,7 mm	0.1457		M4,5 X 0,75	6,0	66,0	28,0	23,0	36,0	65007	64807
3,8 mm	0.1496		10-24	6,0	74,0	36,0	29,0	36,0	65008	64808
3,9 mm	0.1535			6,0	74,0	36,0	29,0	36,0	65009	64809
5/32	0.1562	3.97		6,0	74,0	36,0	29,0	36,0	55003	54803
4,0 mm	0.1575		M4,5 X 0,5	6,0	74,0	36,0	29,0	36,0	65010	64810
#21	0.1590	4.04	10-32	6,0	74,0	36,0	29,0	36,0	55004	54804
4,1 mm	0.1614			6,0	74,0	36,0	29,0	36,0	65011	64811
4,2 mm	0.1654		M5 / M5 x 0,75	6,0	74,0	36,0	29,0	36,0	65012	64812
4,3 mm	0.1693			6,0	74,0	36,0	29,0	36,0	65013	64813
11/64	0.1719	4.37		6,0	74,0	36,0	29,0	36,0	55005	54805
4,4 mm	0.1732		12-24	6,0	74,0	36,0	29,0	36,0	65014	64814
4,5 mm	0.1772		M5 X 0,5	6,0	74,0	36,0	29,0	36,0	65015	64815
4,6 mm	0.1811		12-28	6,0	74,0	36,0	29,0	36,0	65016	64816
4,7 mm	0.1850		12-32	6,0	74,0	36,0	29,0	36,0	65017	64817
3/16	0.1875	4.76		6,0	82,0	44,0	35,0	36,0	55006	54806
4,8 mm	0.1890		7/32-32	6,0	82,0	44,0	35,0	36,0	65018	64818
4,9 mm	0.1929			6,0	82,0	44,0	35,0	36,0	65019	64819
5,0 mm	0.1969		M6 X 1	6,0	82,0	44,0	35,0	36,0	65020	64820
5,1 mm	0.2008		1/4-20	6,0	82,0	44,0	35,0	36,0	65021	64821
13/64	0.2031	5.16		6,0	82,0	44,0	35,0	36,0	55007	54807
5,2 mm	0.2047		M6 X 0,75	6,0	82,0	44,0	35,0	36,0	65022	64822
5,3 mm	0.2087			6,0	82,0	44,0	35,0	36,0	65023	64823
5,4 mm	0.2126			6,0	82,0	44,0	35,0	36,0	65024	64824
5,5 mm	0.2165		M6 X 0,5	6,0	82,0	44,0	35,0	36,0	65025	64825
7/32	0.2188	5.56	1/4-32	6,0	82,0	44,0	35,0	36,0	55008	54808
5,6 mm	0.2205			6,0	82,0	44,0	35,0	36,0	65026	64826

TOLERANCES (inch)

- ≤.1181 DIAMETER**
D₁ = +.0008/+0.0047
D₂ = h₆
- >.1181-.2362 DIAMETER**
D₁ = +.00016/+0.00063
D₂ = h₆
- >.2362-.3937 DIAMETER**
D₁ = +.00024/+0.00083
D₂ = h₆
- >.3937-.7087 DIAMETER**
D₁ = +.00028/+0.00098
D₂ = h₆
- >.7087-1.1811 DIAMETER**
D₁ = +.00031/+0.0114
D₂ = h₆

TOLERANCES (mm)

- ≤3 DIAMETER**
D₁ = +0,002/+0,012
D₂ = h₆
- >3-6 DIAMETER**
D₁ = +0,004/+0,016
D₂ = h₆
- >6-10 DIAMETER**
D₁ = +0,006/+0,021
D₂ = h₆
- >10-18 DIAMETER**
D₁ = +0,007/+0,025
D₂ = h₆

- NON-FERROUS
- PLASTICS/COMPOSITES

For patent information visit www.ksptpatents.com

continued on next page



131N 5xD

FRACTIONAL & METRIC SERIES

CUTTING DIA.	DECIMAL EQUIV.	METRIC EQUIV.	TAP SIZE REFERENCE ONLY	SHANK DIA.	OVERALL LENGTH	FLUTE LENGTH	CLEARED LENGTH	SHANK LENGTH	UNCOATED	Ti-NAMITE-B (TiB ₂)
D ₁				D ₂	L ₁	L ₂	L ₃	L ₄	EDP NO.	EDP NO.
5,7 mm	0.2244			6,0	82,0	44,0	35,0	36,0	65027	64827
5,8 mm	0.2283			6,0	82,0	44,0	35,0	36,0	65028	64828
5,9 mm	0.2323			6,0	82,0	44,0	35,0	36,0	65029	64829
15/64	0.2344	5.95		6,0	82,0	44,0	35,0	36,0	55009	54809
6,0 mm	0.2362		M7 X 1	6,0	82,0	44,0	35,0	36,0	65030	64830
6,1 mm	0.2402			8,0	91,0	53,0	43,0	36,0	65031	64831
6,2 mm	0.2441		M7 X 0,75	8,0	91,0	53,0	43,0	36,0	65032	64832
6,3 mm	0.2480			8,0	91,0	53,0	43,0	36,0	65033	64833
1/4	0.2500	6.35		8,0	91,0	53,0	43,0	36,0	55010	54810
6,4 mm	0.2520			8,0	91,0	53,0	43,0	36,0	65034	64834
6,5 mm	0.2559			8,0	91,0	53,0	43,0	36,0	65035	64835
F	0.2570	6.53	5/16-18	8,0	91,0	53,0	43,0	36,0	55011	54811
6,6 mm	0.2598			8,0	91,0	53,0	43,0	36,0	65036	64836
6,7 mm	0.2638			8,0	91,0	53,0	43,0	36,0	65037	64837
17/64	0.2656	6.75	5/16-20	8,0	91,0	53,0	43,0	36,0	55012	54812
6,8 mm	0.2677		M8 X 1,25	8,0	91,0	53,0	43,0	36,0	65038	64838
6,9 mm	0.2717		5/16-24	8,0	91,0	53,0	43,0	36,0	65039	64839
7,0 mm	0.2756		M8 X 1	8,0	91,0	53,0	43,0	36,0	65040	64840
7,1 mm	0.2795			8,0	91,0	53,0	43,0	36,0	65041	64841
9/32	0.2812	7.14	5/16-32	8,0	91,0	53,0	43,0	36,0	55013	54813
7,2 mm	0.2835		M8 X 0,75	8,0	91,0	53,0	43,0	36,0	65042	64842
7,3 mm	0.2874			8,0	91,0	53,0	43,0	36,0	65043	64843
7,4 mm	0.2913			8,0	91,0	53,0	43,0	36,0	65044	64844
7,5 mm	0.2953		M8 X 0,5	8,0	91,0	53,0	43,0	36,0	65045	64845
19/64	0.2969	7.54		8,0	91,0	53,0	43,0	36,0	55014	54814
7,6 mm	0.2992			8,0	91,0	53,0	43,0	36,0	65046	64846
7,7 mm	0.3031			8,0	91,0	53,0	43,0	36,0	65047	64847
7,8 mm	0.3071		M9 X 1,25	8,0	91,0	53,0	43,0	36,0	65048	64848
7,9 mm	0.3110			8,0	91,0	53,0	43,0	36,0	65049	64849
5/16	0.3125	7.94	3/8-16	8,0	91,0	53,0	43,0	36,0	55015	54815
8,0 mm	0.3150		M9 X 1	8,0	91,0	53,0	43,0	36,0	65050	64850
8,1 mm	0.3189			10,0	103,0	61,0	49,0	40,0	65051	64851
8,2 mm	0.3228			10,0	103,0	61,0	49,0	40,0	65052	64852
8,3 mm	0.3268			10,0	103,0	61,0	49,0	40,0	65053	64853
21/64	0.3281	8.33	3/8-20	10,0	103,0	61,0	49,0	40,0	55016	54816
8,4 mm	0.3307			10,0	103,0	61,0	49,0	40,0	65054	64854
Q	0.3320	8.43	3/8-24	10,0	103,0	61,0	49,0	40,0	55017	54817
8,5 mm	0.3346		M10 X 1,5	10,0	103,0	61,0	49,0	40,0	65055	64855
8,6 mm	0.3386			10,0	103,0	61,0	49,0	40,0	65056	64856
8,7 mm	0.3425			10,0	103,0	61,0	49,0	40,0	65057	64857
11/32	0.3438	8.73	3/8-32	10,0	103,0	61,0	49,0	40,0	55018	54818
8,8 mm	0.3465		M10 X 1,25	10,0	103,0	61,0	49,0	40,0	65058	64858
8,9 mm	0.3504			10,0	103,0	61,0	49,0	40,0	65059	64859
9,0 mm	0.3543		M10 X 1	10,0	103,0	61,0	49,0	40,0	65060	64860
9,1 mm	0.3583			10,0	103,0	61,0	49,0	40,0	65061	64861
23/64	0.3594	9.13		10,0	103,0	61,0	49,0	40,0	55019	54819

CONTINUED

continued on next page

Hi-PerCarb



5xD



131N 5xD

FRACTIONAL & METRIC SERIES

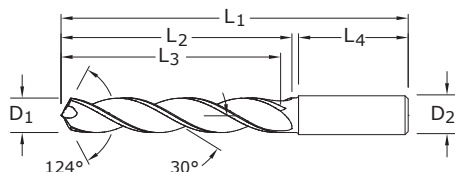

- Triple margin design improves hole stability and size control while providing superior finish, roundness and cylindricity
- Self-stabilizing pyramid point design stabilizes the drill on contact with the workpiece
- Open flute structure efficiently transports chips while maintaining strength at high feed rates
- Sculpted gash allows chips to easily flow away from the drill center
- Recommended for materials ≤ 175 Bhn (≤ 16 HRC)

CUTTING DIA.	DECIMAL EQUIV.	METRIC EQUIV.	TAP SIZE REFERENCE ONLY	SHANK DIA.	OVERALL LENGTH	FLUTE LENGTH	CLEARED LENGTH	SHANK LENGTH	UNCOATED	Ti-NAMITE-B (TiB ₂)
D ₁				D ₂	L ₁	L ₂	L ₃	L ₄	EDP NO.	EDP NO.
9,2 mm	0.3622		M10 X 0,75	10,0	103,0	61,0	49,0	40,0	65062	64862
9,3 mm	0.3661			10,0	103,0	61,0	49,0	40,0	65063	64863
U	0.3680	9.35	7/16-14	10,0	103,0	61,0	49,0	40,0	55020	54820
9,4 mm	0.3701			10,0	103,0	61,0	49,0	40,0	65064	64864
9,5 mm	0.3740		M11 / M10 X 0,5	10,0	103,0	61,0	49,0	40,0	65065	64865
3/8	0.3750	9.53		10,0	103,0	61,0	49,0	40,0	55021	54821
9,6 mm	0.3780			10,0	103,0	61,0	49,0	40,0	65066	64866
9,7 mm	0.3819			10,0	103,0	61,0	49,0	40,0	65067	64867
9,8 mm	0.3858			10,0	103,0	61,0	49,0	40,0	65068	64868
9,9 mm	0.3898			10,0	103,0	61,0	49,0	40,0	65069	64869
25/64	0.3906	9.92	7/16-20	10,0	103,0	61,0	49,0	40,0	55022	54822
10,0 mm	0.3937			10,0	103,0	61,0	49,0	40,0	65070	64870
10,1 mm	0.3976			12,0	118,0	71,0	56,0	45,0	65071	64871
10,2 mm	0.4016		M12 X 1,75	12,0	118,0	71,0	56,0	45,0	65072	64872
10,3 mm	0.4055			12,0	118,0	71,0	56,0	45,0	65073	64873
13/32	0.4062	10.32		12,0	118,0	71,0	56,0	45,0	55023	54823
10,4 mm	0.4094			12,0	118,0	71,0	56,0	45,0	65074	64874
10,5 mm	0.4134		M12 X 1,5	12,0	118,0	71,0	56,0	45,0	65075	64875
10,6 mm	0.4173			12,0	118,0	71,0	56,0	45,0	65076	64876
10,7 mm	0.4213			12,0	118,0	71,0	56,0	45,0	65077	64877
27/64	0.4219	10.72	1/2-13	12,0	118,0	71,0	56,0	45,0	55024	54824
10,8 mm	0.4252		M12 X 1,25	12,0	118,0	71,0	56,0	45,0	65078	64878
10,9 mm	0.4291			12,0	118,0	71,0	56,0	45,0	65079	64879
11,0 mm	0.4331		M12 X 1	12,0	118,0	71,0	56,0	45,0	65080	64880
11,1 mm	0.4370			12,0	118,0	71,0	56,0	45,0	65081	64881
7/16	0.4375	11.11	1/4-18NPT	12,0	118,0	71,0	56,0	45,0	55025	54825
11,2 mm	0.4409			12,0	118,0	71,0	56,0	45,0	65082	64882
11,3 mm	0.4449			12,0	118,0	71,0	56,0	45,0	65083	64883
11,4 mm	0.4488			12,0	118,0	71,0	56,0	45,0	65084	64884
11,5 mm	0.4528		M12 X 0,5	12,0	118,0	71,0	56,0	45,0	65085	64885
11,6 mm	0.4567			12,0	118,0	71,0	56,0	45,0	65086	64886
11,7 mm	0.4606			12,0	118,0	71,0	56,0	45,0	65087	64887
11,8 mm	0.4646			12,0	118,0	71,0	56,0	45,0	65088	64888
11,9 mm	0.4685			12,0	118,0	71,0	56,0	45,0	65089	64889

TOLERANCES (inch)

$\leq .1181$ DIAMETER

D₁ = +.0008/+0.0047

D₂ = h₆

$>.1181-.2362$ DIAMETER

D₁ = +.00016/+0.00063

D₂ = h₆

$>.2362-.3937$ DIAMETER

D₁ = +.00024/+0.00083

D₂ = h₆

$>.3937-.7087$ DIAMETER

D₁ = +.00028/+0.00098

D₂ = h₆

$>.7087-1.1811$ DIAMETER

D₁ = +.00031/+0.0114

D₂ = h₆

TOLERANCES (mm)

≤ 3 DIAMETER

D₁ = +0,002/+0,012

D₂ = h₆

$>3-6$ DIAMETER

D₁ = +0,004/+0,016

D₂ = h₆

$>6-10$ DIAMETER

D₁ = +0,006/+0,021

D₂ = h₆

$>10-18$ DIAMETER

D₁ = +0,007/+0,025

D₂ = h₆

- NON-FERROUS
- PLASTICS/COMPOSITES

For patent information visit www.ksptpatents.com

continued on next page



131N 5xD
 FRACTIONAL & METRIC SERIES

CUTTING DIA.	DECIMAL EQUIV.	METRIC EQUIV.	TAP SIZE REFERENCE ONLY	SHANK DIA.	OVERALL LENGTH	FLUTE LENGTH	CLEARED LENGTH	SHANK LENGTH	UNCOATED	Ti-NAMITE-B (TiB ₂)
D ₁				D ₂	L ₁	L ₂	L ₃	L ₄	EDP NO.	EDP NO.
15/32	0.4688	11.91	1/2-28	12,0	118,0	71,0	56,0	45,0	55026	54826
12,0 mm	0.4724		M14 X 2	12,0	118,0	71,0	56,0	45,0	65090	64890
31/64	0.4844	12.30	9/16-12	14,0	124,0	77,0	60,0	45,0	55027	54827
12,5 mm	0.4921		M14 X 1,5	14,0	124,0	77,0	60,0	45,0	65091	64891
1/2	0.5000	12.70		14,0	124,0	77,0	60,0	45,0	55028	54828
12,8 mm	0.5039		M14 X 1,25	14,0	124,0	77,0	60,0	45,0	65092	64892
13,0 mm	0.5118		M14 X 1	14,0	124,0	77,0	60,0	45,0	65093	64893
33/64	0.5156	13.10	9/16-18	14,0	124,0	77,0	60,0	45,0	55029	54829
13,5 mm	0.5315		5/8-11	14,0	124,0	77,0	60,0	45,0	65094	64894
13,8 mm	0.5433			14,0	124,0	77,0	60,0	45,0	65095	64895
14,0 mm	0.5512		M16 X 2	14,0	124,0	77,0	60,0	45,0	65096	64896
9/16	0.5625	14.29		16,0	133,0	83,0	63,0	48,0	55030	54830
14,5 mm	0.5709		M16 X 1,5	16,0	133,0	83,0	63,0	48,0	65097	64897
37/64	0.5781	14.68	5/8-18	16,0	133,0	83,0	63,0	48,0	55031	54831
14,8 mm	0.5827			16,0	133,0	83,0	63,0	48,0	65098	64898
15,0 mm	0.5906		M16 X 1	16,0	133,0	83,0	63,0	48,0	65099	64899
15,5 mm	0.6102		M18 X 2,5	16,0	133,0	83,0	63,0	48,0	65100	64900
15,8 mm	0.6220			16,0	133,0	83,0	63,0	48,0	65101	64901
5/8	0.6250	15.88	11/16-16	16,0	133,0	83,0	63,0	48,0	55032	54832
16,0 mm	0.6299			16,0	133,0	83,0	63,0	48,0	65102	64902
21/32	0.6562	16.67	3/4-10	18,0	143,0	93,0	71,0	48,0	55033	54833
11/16	0.6875	17.46	3/4-16	18,0	143,0	93,0	71,0	48,0	55034	54834
3/4	0.7500	19.05	13/16-16	20,0	153,0	101,0	77,0	50,0	55035	54835

CONTINUED

FRACTIONAL Hi-PerCarb

Series 131N 3D & 5D Fractional	Hardness	Vc (sfm)		Diameter (D ₁) (inch)							
				1/8	3/16	1/4	3/8	1/2	5/8	3/4	
N	ALUMINUM ALLOYS < 12% SI 6061, 2024, 7075	≤ 150 Bhn or ≤ 7 HRc	800	RPM	24448	16299	12224	8149	6112	4890	4075
			(640-960)	Fr	0.0055	0.0083	0.0110	0.0166	0.0221	0.0276	0.0331
				Feed (ipm)	135	135	135	135	135	135	135
	ALUMINUM ALLOYS > 12% SI A356.0, 390.0, 319.0	≤ 125 Bhn or ≤ 77 HRb	600	RPM	18336	12224	9168	6112	4584	3667	3056
			(480-720)	Fr	0.0055	0.0082	0.0109	0.0164	0.0218	0.0273	0.0327
				Feed (ipm)	100	100	100	100	100	100	100
	COPPER ALLOYS Alum Bronze, Muntz Brass, Naval Brass	≤ 175 Bhn or ≤ 16 HRc	550	RPM	16808	11205	8404	5603	4202	3362	2801
			(440-660)	Fr	0.0020	0.0030	0.0040	0.0061	0.0081	0.0101	0.0121
				Feed (ipm)	34	34	34	34	34	34	34
PLASTICS Acrylic, PVC, Polypropylene		450	RPM	13752	9168	6876	4584	3438	2750	2292	
		(360-540)	Fr	0.0025	0.0037	0.0049	0.0074	0.0099	0.0124	0.0148	
			Feed (ipm)	34	34	34	34	34	34	34	

Bhn (Brinell) HRc (Rockwell C) HRb (Rockwell B)

$rpm = Vc \times 3.82 / D_1$

$ipm = Fr \times rpm$

reduce speed and feed for materials harder than listed

refer to the KYOCERA SGS Tool Wizard® for complete technical information (www.kyocera-sgstool.com)

Series 131N 3D & 5D Metric	Hardness	Vc (m/min)	Diameter (D ₁) (mm)							
			3	6	8	10	12	14	16	
ALUMINUM ALLOYS < 12% SI 6061, 2024, 7075	≤ 150 Bhn or ≤ 7 HRc	244	RPM	25851	12926	9694	7755	6463	5540	4847
		(195-293)	Fr	0.133	0.265	0.354	0.442	0.531	0.619	0.708
			Feed (mm/min)	3430	3430	3430	3430	3430	3430	3430
ALUMINUM ALLOYS > 12% SI A356.0, 390.0, 319.0	≤ 125 Bhn or ≤ 77 HRb	183	RPM	19388	9694	7271	5816	4847	4155	3635
		(146-219)	Fr	0.131	0.262	0.349	0.437	0.524	0.611	0.699
			Feed (mm/min)	2540	2540	2540	2540	2540	2540	2540
COPPER ALLOYS Alum Bronze, Muntz Brass, Naval Brass	≤ 175 Bhn or ≤ 16 HRc	168	RPM	17773	8886	6665	5332	4443	3808	3332
		(134-201)	Fr	0.049	0.097	0.130	0.162	0.194	0.227	0.259
			Feed (mm/min)	864	864	864	864	864	864	864
PLASTICS Acrylic, PVC, Polypropylene		137	RPM	14541	7271	5453	4362	3635	3116	2726
		(110-165)	Fr	0.059	0.119	0.158	0.198	0.238	0.277	0.317
			Feed (mm/min)	864	864	864	864	864	864	864

Bhn (Brinell) HRc (Rockwell C) HRb (Rockwell B)
 $rpm = (Vc \times 1000) / (D_1 \times 3.14)$
 $mm/min = Fr \times rpm$
 reduce speed and feed for materials harder than listed
 refer to the KYOCERA SGS Tool Wizard® for complete technical information (www.kyocera-sgstool.com)

Hi-PerCarb



5xD



3

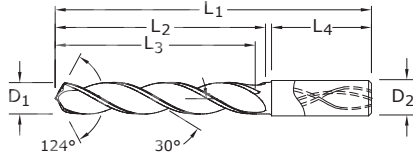

141K 5xD

FRACTIONAL & METRIC SERIES

- Triple margin design improves hole stability and size control while providing superior finish, roundness and cylindricity
- Self-stabilizing pyramid point design stabilizes the drill on contact with the workpiece
- Open flute structure efficiently transports chips while maintaining strength at high feed rates
- Sculpted gash allows chips to easily flow away from the drill center
- Recommended for materials ≤ 400 Bhn (≤ 43 HRC)

CUTTING DIA.	DECIMAL EQUIV.	METRIC EQUIV.	TAP SIZE REFERENCE ONLY	SHANK DIA.	OVERALL LENGTH	FLUTE LENGTH	CLEARED LENGTH	SHANK LENGTH	Ti-NAMITE-M (TM)
D ₁				D ₂	L ₁	L ₂	L ₃	L ₄	EDP NO.
3,0 mm	0.1181			6,0	66,0	28,0	23,0	36,0	65160
3,1 mm	0.1220			6,0	66,0	28,0	23,0	36,0	65161
1/8	0.1250	3.18		6,0	66,0	28,0	23,0	36,0	55160
3,2 mm	0.1260		M3,5 X 0,35	6,0	66,0	28,0	23,0	36,0	65162
3,3 mm	0.1299		M4 X 0,7	6,0	66,0	28,0	23,0	36,0	65163
3,4 mm	0.1339			6,0	66,0	28,0	23,0	36,0	65164
#29	0.1360	3.45	8-32,8-36	6,0	66,0	28,0	23,0	36,0	55161
3,5 mm	0.1378		M4 X 0,5	6,0	66,0	28,0	23,0	36,0	65165
9/64	0.1406	3.57		6,0	66,0	28,0	23,0	36,0	55162
3,6 mm	0.1417		M4 X 0,35	6,0	66,0	28,0	23,0	36,0	65166
3,7 mm	0.1457		M4,5 X 0,75	6,0	66,0	28,0	23,0	36,0	65167
3,8 mm	0.1496		10-24	6,0	74,0	36,0	29,0	36,0	65168
3,9 mm	0.1535			6,0	74,0	36,0	29,0	36,0	65169
5/32	0.1562	3.97		6,0	74,0	36,0	29,0	36,0	55163
4,0 mm	0.1575		M4,5 X 0,5	6,0	74,0	36,0	29,0	36,0	65170
#21	0.1590	4.04	10-32	6,0	74,0	36,0	29,0	36,0	55164
4,1 mm	0.1614			6,0	74,0	36,0	29,0	36,0	65171
4,2 mm	0.1654		M5 / M5 x 0,75	6,0	74,0	36,0	29,0	36,0	65172
4,3 mm	0.1693			6,0	74,0	36,0	29,0	36,0	65173
11/64	0.1719	4.37		6,0	74,0	36,0	29,0	36,0	55165
4,4 mm	0.1732		12-24	6,0	74,0	36,0	29,0	36,0	65174
4,5 mm	0.1772		M5 X 0,5	6,0	74,0	36,0	29,0	36,0	65175
4,6 mm	0.1811		12-28	6,0	74,0	36,0	29,0	36,0	65176
4,7 mm	0.1850		12-32	6,0	74,0	36,0	29,0	36,0	65177
3/16	0.1875	4.76		6,0	82,0	44,0	35,0	36,0	55166
4,8 mm	0.1890		7/32-32	6,0	82,0	44,0	35,0	36,0	65178
4,9 mm	0.1929			6,0	82,0	44,0	35,0	36,0	65179
5,0 mm	0.1969		M6 X 1	6,0	82,0	44,0	35,0	36,0	65180
5,1 mm	0.2008		1/4-20	6,0	82,0	44,0	35,0	36,0	65181
13/64	0.2031	5.16		6,0	82,0	44,0	35,0	36,0	55167
5,2 mm	0.2047		M6 X 0,75	6,0	82,0	44,0	35,0	36,0	65182
5,3 mm	0.2087			6,0	82,0	44,0	35,0	36,0	65183
5,4 mm	0.2126			6,0	82,0	44,0	35,0	36,0	65184
5,5 mm	0.2165		M6 X 0,5	6,0	82,0	44,0	35,0	36,0	65185
7/32	0.2188	5.56	1/4-32	6,0	82,0	44,0	35,0	36,0	55168
5,6 mm	0.2205			6,0	82,0	44,0	35,0	36,0	65186

TOLERANCES (inch)

$\leq .1181$ DIAMETER

D₁ = +.00008/+0.00047

D₂ = h₆

$>.1181-.2362$ DIAMETER

D₁ = +.00016/+0.00063

D₂ = h₆

$>.2362-.3937$ DIAMETER

D₁ = +.00024/+0.00083

D₂ = h₆

$>.3937-.7087$ DIAMETER

D₁ = +.00028/+0.00098

D₂ = h₆

$>.7087-1.1811$ DIAMETER

D₁ = +.00031/+0.00114

D₂ = h₆

TOLERANCES (mm)

≤ 3 DIAMETER

D₁ = +0,002/+0,012

D₂ = h₆

$>3-6$ DIAMETER

D₁ = +0,004/+0,016

D₂ = h₆

$>6-10$ DIAMETER

D₁ = +0,006/+0,021

D₂ = h₆

$>10-18$ DIAMETER

D₁ = +0,007/+0,025

D₂ = h₆

CAST IRON

For patent information visit www.ksptpatents.com

continued on next page



141K 5xD

FRACTIONAL & METRIC SERIES

CUTTING DIA.	DECIMAL EQUIV.	METRIC EQUIV.	TAP SIZE REFERENCE ONLY	SHANK DIA.	OVERALL LENGTH	FLUTE LENGTH	CLEARED LENGTH	SHANK LENGTH	Ti-NAMITE-M (TM)
D ₁				D ₂	L ₁	L ₂	L ₃	L ₄	EDP NO.
5,7 mm	0.2244			6,0	82,0	44,0	35,0	36,0	65187
5,8 mm	0.2283			6,0	82,0	44,0	35,0	36,0	65188
5,9 mm	0.2323			6,0	82,0	44,0	35,0	36,0	65189
15/64	0.2344	5.95		6,0	82,0	44,0	35,0	36,0	55169
6,0 mm	0.2362		M7 X 1	6,0	82,0	44,0	35,0	36,0	65190
6,1 mm	0.2402			8,0	91,0	53,0	43,0	36,0	65191
6,2 mm	0.2441		M7 X 0,75	8,0	91,0	53,0	43,0	36,0	65192
6,3 mm	0.2480			8,0	91,0	53,0	43,0	36,0	65193
1/4	0.2500	6.35		8,0	91,0	53,0	43,0	36,0	55170
6,4 mm	0.2520			8,0	91,0	53,0	43,0	36,0	65194
6,5 mm	0.2559			8,0	91,0	53,0	43,0	36,0	65195
F	0.2570	6.53	5/16-18	8,0	91,0	53,0	43,0	36,0	55171
6,6 mm	0.2598			8,0	91,0	53,0	43,0	36,0	65196
6,7 mm	0.2638			8,0	91,0	53,0	43,0	36,0	65197
17/64	0.2656	6.75	5/16-20	8,0	91,0	53,0	43,0	36,0	55172
6,8 mm	0.2677		M8 X 1,25	8,0	91,0	53,0	43,0	36,0	65198
6,9 mm	0.2717		5/16-24	8,0	91,0	53,0	43,0	36,0	65199
7,0 mm	0.2756		M8 X 1	8,0	91,0	53,0	43,0	36,0	65200
7,1 mm	0.2795			8,0	91,0	53,0	43,0	36,0	65201
9/32	0.2812	7.14	5/16-32	8,0	91,0	53,0	43,0	36,0	55173
7,2 mm	0.2835		M8 X 0,75	8,0	91,0	53,0	43,0	36,0	65202
7,3 mm	0.2874			8,0	91,0	53,0	43,0	36,0	65203
7,4 mm	0.2913			8,0	91,0	53,0	43,0	36,0	65204
7,5 mm	0.2953		M8 X 0,5	8,0	91,0	53,0	43,0	36,0	65205
19/64	0.2969	7.54		8,0	91,0	53,0	43,0	36,0	55174
7,6 mm	0.2992			8,0	91,0	53,0	43,0	36,0	65206
7,7 mm	0.3031			8,0	91,0	53,0	43,0	36,0	65207
7,8 mm	0.3071		M9 X 1,25	8,0	91,0	53,0	43,0	36,0	65208
7,9 mm	0.3110			8,0	91,0	53,0	43,0	36,0	65209
5/16	0.3125	7.94	3/8-16	8,0	91,0	53,0	43,0	36,0	55175
8,0 mm	0.3150		M9 X 1	8,0	91,0	53,0	43,0	36,0	65210
8,1 mm	0.3189			10,0	103,0	61,0	49,0	40,0	65211
8,2 mm	0.3228			10,0	103,0	61,0	49,0	40,0	65212
8,3 mm	0.3268			10,0	103,0	61,0	49,0	40,0	65213
21/64	0.3281	8.33	3/8-20	10,0	103,0	61,0	49,0	40,0	55176
8,4 mm	0.3307			10,0	103,0	61,0	49,0	40,0	65214
Q	0.3320	8.43	3/8-24	10,0	103,0	61,0	49,0	40,0	55177
8,5 mm	0.3346		M10 X 1,5	10,0	103,0	61,0	49,0	40,0	65215
8,6 mm	0.3386			10,0	103,0	61,0	49,0	40,0	65216
8,7 mm	0.3425			10,0	103,0	61,0	49,0	40,0	65217
11/32	0.3438	8.73	3/8-32	10,0	103,0	61,0	49,0	40,0	55178
8,8 mm	0.3465		M10 X 1,25	10,0	103,0	61,0	49,0	40,0	65218
8,9 mm	0.3504			10,0	103,0	61,0	49,0	40,0	65219
9,0 mm	0.3543		M10 X 1	10,0	103,0	61,0	49,0	40,0	65220
9,1 mm	0.3583			10,0	103,0	61,0	49,0	40,0	65221
23/64	0.3594	9.13		10,0	103,0	61,0	49,0	40,0	55179

CONTINUED

continued on next page

Hi-PerCarb



5xD



3

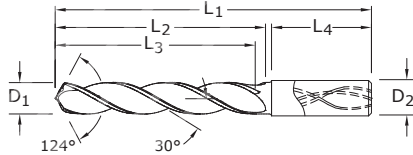

141K 5xD

FRACTIONAL & METRIC SERIES

- Triple margin design improves hole stability and size control while providing superior finish, roundness and cylindricity
- Self-stabilizing pyramid point design stabilizes the drill on contact with the workpiece
- Open flute structure efficiently transports chips while maintaining strength at high feed rates
- Sculpted gash allows chips to easily flow away from the drill center
- Recommended for materials ≤ 400 Bhn (≤ 43 HRC)

CUTTING DIA.	DECIMAL EQUIV.	METRIC EQUIV.	TAP SIZE REFERENCE ONLY	SHANK DIA.	OVERALL LENGTH	FLUTE LENGTH	CLEARED LENGTH	SHANK LENGTH	Ti-NAMITE-M (TM)
D ₁				D ₂	L ₁	L ₂	L ₃	L ₄	EDP NO.
9,2 mm	0.3622		M10 X 0,75	10,0	103,0	61,0	49,0	40,0	65222
9,3 mm	0.3661			10,0	103,0	61,0	49,0	40,0	65223
U	0.3680	9.35	7/16-14	10,0	103,0	61,0	49,0	40,0	55180
9,4 mm	0.3701			10,0	103,0	61,0	49,0	40,0	65224
9,5 mm	0.3740		M11 / M10 X 0,5	10,0	103,0	61,0	49,0	40,0	65225
3/8	0.3750	9.53		10,0	103,0	61,0	49,0	40,0	55181
9,6 mm	0.3780			10,0	103,0	61,0	49,0	40,0	65226
9,7 mm	0.3819			10,0	103,0	61,0	49,0	40,0	65227
9,8 mm	0.3858			10,0	103,0	61,0	49,0	40,0	65228
9,9 mm	0.3898			10,0	103,0	61,0	49,0	40,0	65229
25/64	0.3906	9.92	7/16-20	10,0	103,0	61,0	49,0	40,0	55182
10,0 mm	0.3937			10,0	103,0	61,0	49,0	40,0	65230
10,1 mm	0.3976			12,0	118,0	71,0	56,0	45,0	65231
10,2 mm	0.4016		M12 X 1,75	12,0	118,0	71,0	56,0	45,0	65232
10,3 mm	0.4055			12,0	118,0	71,0	56,0	45,0	65233
13/32	0.4062	10.32		12,0	118,0	71,0	56,0	45,0	55183
10,4 mm	0.4094			12,0	118,0	71,0	56,0	45,0	65234
10,5 mm	0.4134		M12 X 1,5	12,0	118,0	71,0	56,0	45,0	65235
10,6 mm	0.4173			12,0	118,0	71,0	56,0	45,0	65236
10,7 mm	0.4213			12,0	118,0	71,0	56,0	45,0	65237
27/64	0.4219	10.72	1/2-13	12,0	118,0	71,0	56,0	45,0	55184
10,8 mm	0.4252		M12 X 1,25	12,0	118,0	71,0	56,0	45,0	65238
10,9 mm	0.4291			12,0	118,0	71,0	56,0	45,0	65239
11,0 mm	0.4331		M12 X 1	12,0	118,0	71,0	56,0	45,0	65240
11,1 mm	0.4370			12,0	118,0	71,0	56,0	45,0	65241
7/16	0.4375	11.11	1/4-18NPT	12,0	118,0	71,0	56,0	45,0	55185
11,2 mm	0.4409			12,0	118,0	71,0	56,0	45,0	65242
11,3 mm	0.4449			12,0	118,0	71,0	56,0	45,0	65243
11,4 mm	0.4488			12,0	118,0	71,0	56,0	45,0	65244
11,5 mm	0.4528		M12 X 0,5	12,0	118,0	71,0	56,0	45,0	65245
11,6 mm	0.4567			12,0	118,0	71,0	56,0	45,0	65246
11,7 mm	0.4606			12,0	118,0	71,0	56,0	45,0	65247
11,8 mm	0.4646			12,0	118,0	71,0	56,0	45,0	65248
11,9 mm	0.4685			12,0	118,0	71,0	56,0	45,0	65249
15/32	0.4688	11.91	1/2-28	12,0	118,0	71,0	56,0	45,0	55186
12,0 mm	0.4724		M14 X 2	12,0	118,0	71,0	56,0	45,0	65250

TOLERANCES (inch)

- ≤.1181 DIAMETER**
D₁ = +.0008/+0.0047
D₂ = h₆
- >.1181-.2362 DIAMETER**
D₁ = +.00016/+0.0063
D₂ = h₆
- >.2362-.3937 DIAMETER**
D₁ = +.00024/+0.0083
D₂ = h₆
- >.3937-.7087 DIAMETER**
D₁ = +.00028/+0.0098
D₂ = h₆
- >.7087-1.1811 DIAMETER**
D₁ = +.00031/+0.0114
D₂ = h₆

TOLERANCES (mm)

- ≤3 DIAMETER**
D₁ = +0,002/+0,012
D₂ = h₆
- >3-6 DIAMETER**
D₁ = +0,004/+0,016
D₂ = h₆
- >6-10 DIAMETER**
D₁ = +0,006/+0,021
D₂ = h₆
- >10-18 DIAMETER**
D₁ = +0,007/+0,025
D₂ = h₆

CAST IRON

For patent information visit www.ksptpatents.com

continued on next page



141K 5xD
FRACTIONAL & METRIC SERIES

CUTTING DIA.	DECIMAL EQUIV.	METRIC EQUIV.	TAP SIZE REFERENCE ONLY	SHANK DIA.	OVERALL LENGTH	FLUTE LENGTH	CLEARED LENGTH	SHANK LENGTH	Ti-NAMITE-M (TM)
D ₁				D ₂	L ₁	L ₂	L ₃	L ₄	EDP NO.
31/64	0.4844	12.30	9/16-12	14,0	124,0	77,0	60,0	45,0	55187
12,5 mm	0.4921		M14 X 1,5	14,0	124,0	77,0	60,0	45,0	65251
1/2	0.5000	12.70		14,0	124,0	77,0	60,0	45,0	55188
12,8 mm	0.5039		M14 X 1,25	14,0	124,0	77,0	60,0	45,0	65252
13,0 mm	0.5118		M14 X 1	14,0	124,0	77,0	60,0	45,0	65253
33/64	0.5156	13.10	9/16-18	14,0	124,0	77,0	60,0	45,0	55189
13,5 mm	0.5315		5/8-11	14,0	124,0	77,0	60,0	45,0	65254
13,8 mm	0.5433			14,0	124,0	77,0	60,0	45,0	65255
14,0 mm	0.5512		M16 X 2	14,0	124,0	77,0	60,0	45,0	65256
9/16	0.5625	14.29		16,0	133,0	83,0	63,0	48,0	55190
14,5 mm	0.5709		M16 X 1,5	16,0	133,0	83,0	63,0	48,0	65257
37/64	0.5781	14.68	5/8-18	16,0	133,0	83,0	63,0	48,0	55191
14,8 mm	0.5827			16,0	133,0	83,0	63,0	48,0	65258
15,0 mm	0.5906		M16 X 1	16,0	133,0	83,0	63,0	48,0	65259
15,5 mm	0.6102		M18 X 2,5	16,0	133,0	83,0	63,0	48,0	65260
15,8 mm	0.6220			16,0	133,0	83,0	63,0	48,0	65261
5/8	0.6250	15.88	11/16-16	16,0	133,0	83,0	63,0	48,0	55192
16,0 mm	0.6299			16,0	133,0	83,0	63,0	48,0	65262
21/32	0.6562	16.67	3/4-10	18,0	143,0	93,0	71,0	48,0	55193
11/16	0.6875	17.46	3/4-16	18,0	143,0	93,0	71,0	48,0	55194
3/4	0.7500	19.05	13/16-16	20,0	153,0	101,0	77,0	50,0	55195

CONTINUED

FRACTIONAL Hi-PerCarb

Series 141K 5D Fractional	Hardness	Vc (sfm)		Diameter (D ₁) (inch)						
				1/8	3/16	1/4	3/8	1/2	5/8	3/4
GRAY CAST IRON FERRITIC ASTM A48: CLASS 20 SAE J431C: GRADE 1800	≤ 150 Bhn or ≤ 80 HRb	450 (360-540)	RPM	13752	9168	6876	4584	3438	2750	2292
			Fr	0.0049	0.0074	0.0099	0.0148	0.0198	0.0247	0.0297
			Feed (ipm)	68	68	68	68	68	68	68
GRAY CAST IRON PEARLITIC ASTM A48: CLASS 30, 35, 40 SAE J431C: GRADE 3000	≤ 220 Bhn or ≤ 19 HRc	375 (300-450)	RPM	11460	7640	5730	3820	2865	2292	1910
			Fr	0.0039	0.0059	0.0079	0.0118	0.0157	0.0196	0.0236
			Feed (ipm)	45	45	45	45	45	45	45
K COMPACTED GRAPHITE IRON	≤ 250 Bhn or ≤ 25 HRc	325 (260-390)	RPM	9932	6621	4966	3311	2483	1986	1655
			Fr	0.0039	0.0059	0.0079	0.0118	0.0157	0.0196	0.0236
			Feed (ipm)	39	39	39	39	39	39	39
MALLEABLE CAST IRON FERRITIC ASTM A220: GRADE 40010 SAE J158: GRADE M4504	≤ 160 Bhn or ≤ 3 HRc	450 (360-540)	RPM	13752	9168	6876	4584	3438	2750	2292
			Fr	0.0049	0.0074	0.0099	0.0148	0.0198	0.0247	0.0297
			Feed (ipm)	68	68	68	68	68	68	68
MALLEABLE CAST IRON MARTENSITE ASTM A220: GRADE 90001 SAE J158: GRADE M8501	≤ 320 Bhn or ≤ 34 HRc	250 (200-300)	RPM	7640	5093	3820	2547	1910	1528	1273
			Fr	0.0031	0.0047	0.0063	0.0094	0.0126	0.0157	0.0188
			Feed (mm/ min)	24	24	24	24	24	24	24

Bhn (Brinell) HRc (Rockwell C) HRb (Rockwell B)

$rpm = Vc \times 3.82 / D_1$

$ipm = Fr \times rpm$

reduce speed and feed for materials harder than listed

refer to the KYOCERA SGS Tool Wizard® for complete technical information (www.kyocera-sgstool.com)

Series 141K 5D Metric	Hardness	Vc (m/min)		Diameter (D ₁) (mm)								
				3	6	8	10	12	14	16		
K	GRAY CAST IRON FERRITIC ASTM A48: CLASS 20 SAE J431C: GRADE 1800	≤ 150 Bhn or ≤ 80 HRb	137	RPM	14541	7271	5453	4362	3635	3116	2726	
			(110-165)	Fr	0.119	0.237	0.316	0.395	0.475	0.554	0.633	
				Feed (mm/min)	1725	1725	1725	1725	1725	1725	1725	1725
	GRAY CAST IRON PEARLITIC ASTM A48: CLASS 30, 35, 40 SAE J431C: GRADE 3000	≤ 220 Bhn or ≤ 19 HRc	114 (91-137)		RPM	12118	6059	4544	3635	3029	2597	2272
					Fr	0.094	0.189	0.252	0.315	0.378	0.441	0.504
					Feed (mm/min)	1145	1145	1145	1145	1145	1145	1145
	COMPACTED GRAPHITE IRON	≤ 250 Bhn or ≤ 25 HRc	99 (79-119)		RPM	10502	5251	3938	3151	2626	2250	1969
					Fr	0.094	0.189	0.251	0.314	0.377	0.440	0.503
					Feed (mm/min)	990	990	990	990	990	990	990
MALLEABLE CAST IRON FERRITIC ASTM A220: GRADE 40010 SAE J158: GRADE M4504	≤ 160 Bhn or ≤ 3 HRc	137 (110-165)		RPM	14541	7271	5453	4362	3635	3116	2726	
				Fr	0.119	0.237	0.316	0.395	0.475	0.554	0.633	
				Feed (mm/min)	1725	1725	1725	1725	1725	1725	1725	1725
MALLEABLE CAST IRON MARTENSITE ASTM A220: GRADE 90001 SAE J158: GRADE M8501	≤ 320 Bhn or ≤ 34 HRc	76 (61-91)		RPM	8078	4039	3029	2424	2020	1731	1515	
				Fr	0.076	0.151	0.201	0.252	0.302	0.352	0.403	
				Feed (mm/min)	610	610	610	610	610	610	610	610

(Brinell) HRc (Rockwell C) HRb (Rockwell B)

rpm = (Vc x 1000) / (D₁ x 3.14)

mm/min = Fr x rpm

reduce speed and feed for materials harder than listed

refer to the KYOCERA SGS Tool Wizard® for complete technical information (www.kyocera-sgstool.com)



5xD

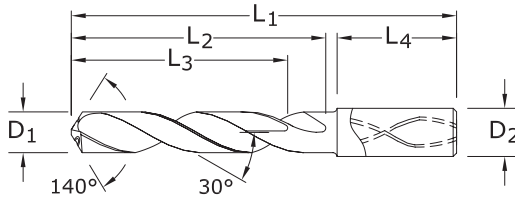

140 5xD

FRACTIONAL & METRIC SERIES

- Coolant through design promotes controlled and consistent operating temperatures improving coolant flow to the cut while maintaining strength
- Split point geometry for improved drill penetration and accuracy
- Controlled edge honing for longevity
- Negative corner position strengthens and protects
- Recommended for materials ≤ 60 HRc (≤ 654 Bhn)

CUTTING DIAMETER	DECIMAL EQUIV.	METRIC EQUIV.	TAP SIZE REFERENCE ONLY	mm					Ti-NAMITE-A (AlTiN)
				SHANK DIAMETER	OVERALL LENGTH	FLUTE LENGTH	CLEARED LENGTH	SHANK LENGTH	
D ₁				D ₂	L ₁	L ₂	L ₃	L ₄	EDP NO.
3,0 mm	0.1181			6,0	66,0	28,0	23,0	36,0	63901
3,1 mm	0.1220			6,0	66,0	28,0	23,0	36,0	63902
1/8	0.1250	3.18		6,0	66,0	28,0	23,0	36,0	51901
3,2 mm	0.1260		M3,5 X 0,35	6,0	66,0	28,0	23,0	36,0	63903
3,3 mm	0.1299		M4 X 0,7	6,0	66,0	28,0	23,0	36,0	63904
3,4 mm	0.1339			6,0	66,0	28,0	23,0	36,0	63905
#29	0.1360	3.45	8-32,8-36	6,0	66,0	28,0	23,0	36,0	51902
3,5 mm	0.1378		M4 X 0,5	6,0	66,0	28,0	23,0	36,0	63906
9/64	0.1406	3.57		6,0	66,0	28,0	23,0	36,0	51903
3,6 mm	0.1417		M4 X 0,35	6,0	66,0	28,0	23,0	36,0	63907
3,7 mm	0.1457		M4,5 X 0,75	6,0	66,0	28,0	23,0	36,0	63908
3,8 mm	0.1496		10-24	6,0	74,0	36,0	29,0	36,0	51904
3,9 mm	0.1535			6,0	74,0	36,0	29,0	36,0	63909
5/32	0.1562	3.97		6,0	74,0	36,0	29,0	36,0	51905
4,0 mm	0.1575		M4,5 X 0,5	6,0	74,0	36,0	29,0	36,0	63910
#21	0.1590	4.04	10-32	6,0	74,0	36,0	29,0	36,0	51906
4,1 mm	0.1614			6,0	74,0	36,0	29,0	36,0	63911
4,2 mm	0.1654		M5 / M5 x 0,75	6,0	74,0	36,0	29,0	36,0	63912
4,3 mm	0.1693			6,0	74,0	36,0	29,0	36,0	63913
11/64	0.1719	4.37		6,0	74,0	36,0	29,0	36,0	51907
4,4 mm	0.1732		12-24	6,0	74,0	36,0	29,0	36,0	63914
4,5 mm	0.1772		M5 X 0,5	6,0	74,0	36,0	29,0	36,0	63915
4,6 mm	0.1811		12-28	6,0	74,0	36,0	29,0	36,0	63916
4,7 mm	0.1850		12-32	6,0	74,0	36,0	29,0	36,0	63917
3/16	0.1875	4.76		6,0	82,0	44,0	35,0	36,0	51908
4,8 mm	0.1890		7/32-32	6,0	82,0	44,0	35,0	36,0	63918
4,9 mm	0.1929			6,0	82,0	44,0	35,0	36,0	63919
5,0 mm	0.1969		M6 X 1	6,0	82,0	44,0	35,0	36,0	63920
5,1 mm	0.2008		1/4-20	6,0	82,0	44,0	35,0	36,0	63900
13/64	0.2031	5.16		6,0	82,0	44,0	35,0	36,0	51910
5,2 mm	0.2047		M6 X 0,75	6,0	82,0	44,0	35,0	36,0	63921
5,3 mm	0.2087			6,0	82,0	44,0	35,0	36,0	63922
5,4 mm	0.2126			6,0	82,0	44,0	35,0	36,0	63998
5,5 mm	0.2165		M6 X 0,5	6,0	82,0	44,0	35,0	36,0	63923

TOLERANCES (inch)

- ≤.1181 DIAMETER
D₁ = +.00008/+0.00047
D₂ = h₆
- >.1181-.2362 DIAMETER
D₁ = +.00016/+0.00063
D₂ = h₆
- >.2362-.3937 DIAMETER
D₁ = +.00024/+0.00083
D₂ = h₆
- >.3937-.7087 DIAMETER
D₁ = +.00028/+0.00098
D₂ = h₆
- >.7087-1.1811 DIAMETER
D₁ = +.00031/+0.00114
D₂ = h₆

TOLERANCES (mm)

- ≤3 DIAMETER
D₁ = +0,002/+0,012
D₂ = h₆
- >3-6 DIAMETER
D₁ = +0,004/+0,016
D₂ = h₆
- >6-10 DIAMETER
D₁ = +0,006/+0,021
D₂ = h₆
- >10-18 DIAMETER
D₁ = +0,007/+0,025
D₂ = h₆

- STEELS
- STAINLESS STEELS
- CAST IRON
- HIGH TEMP ALLOYS
- TITANIUM
- NON-FERROUS
- HARDENED STEELS

For patent information visit www.ksptpatents.com

continued on next page

140 5xD

FRACTIONAL & METRIC SERIES

CONTINUED

CUTTING DIAMETER	DECIMAL EQUIV.	METRIC EQUIV.	TAP SIZE REFERENCE ONLY	mm					Ti-NAMITE-A (AITiN)
				SHANK DIAMETER	OVERALL LENGTH	FLUTE LENGTH	CLEARED LENGTH	SHANK LENGTH	
D ₁				D ₂	L ₁	L ₂	L ₃	L ₄	EDP NO.
7/32	0.2188	5.56	1/4-32	6,0	82,0	44,0	35,0	36,0	51912
5,6 mm	0.2205			6,0	82,0	44,0	35,0	36,0	63924
5,7 mm	0.2244			6,0	82,0	44,0	35,0	36,0	63925
5,8 mm	0.2283			6,0	82,0	44,0	35,0	36,0	63926
5,9 mm	0.2323			6,0	82,0	44,0	35,0	36,0	63927
15/64	0.2344	5.95		6,0	82,0	44,0	35,0	36,0	51913
6,0 mm	0.2362		M7 X 1	6,0	82,0	44,0	35,0	36,0	63928
6,1 mm	0.2402			8,0	91,0	53,0	43,0	36,0	63929
6,2 mm	0.2441		M7 X 0,75	8,0	91,0	53,0	43,0	36,0	63930
6,3 mm	0.2480			8,0	91,0	53,0	43,0	36,0	63931
1/4	0.2500	6.35		8,0	91,0	53,0	43,0	36,0	51914
6,4 mm	0.2520			8,0	91,0	53,0	43,0	36,0	63932
6,5 mm	0.2559			8,0	91,0	53,0	43,0	36,0	63933
F	0.2570	6.53	5/16-18	8,0	91,0	53,0	43,0	36,0	51915
6,6 mm	0.2598			8,0	91,0	53,0	43,0	36,0	63934
6,7 mm	0.2638			8,0	91,0	53,0	43,0	36,0	63935
17/64	0.2656	6.75	5/16-20	8,0	91,0	53,0	43,0	36,0	51916
6,8 mm	0.2677		M8 X 1,25	8,0	91,0	53,0	43,0	36,0	63936
6,9 mm	0.2717		5/16-24	8,0	91,0	53,0	43,0	36,0	63999
7,0 mm	0.2756		M8 X 1	8,0	91,0	53,0	43,0	36,0	63937
7,1 mm	0.2795			8,0	91,0	53,0	43,0	36,0	63938
9/32	0.2812	7.14	5/16-32	8,0	91,0	53,0	43,0	36,0	51918
7,2 mm	0.2835		M8 X 0,75	8,0	91,0	53,0	43,0	36,0	63939
7,3 mm	0.2874			8,0	91,0	53,0	43,0	36,0	63940
7,4 mm	0.2913			8,0	91,0	53,0	43,0	36,0	63941
7,5 mm	0.2953		M8 X 0,5	8,0	91,0	53,0	43,0	36,0	63942
19/64	0.2969	7.54		8,0	91,0	53,0	43,0	36,0	51919
7,6 mm	0.2992			8,0	91,0	53,0	43,0	36,0	63943
7,7 mm	0.3031			8,0	91,0	53,0	43,0	36,0	63944
7,8 mm	0.3071		M9 X 1,25	8,0	91,0	53,0	43,0	36,0	63945
7,9 mm	0.3110			8,0	91,0	53,0	43,0	36,0	63946
5/16	0.3125	7.94	3/8-16	8,0	91,0	53,0	43,0	36,0	51920
8,0 mm	0.3150		M9 X 1	8,0	91,0	53,0	43,0	36,0	63947
8,1 mm	0.3189			10,0	103,0	61,0	49,0	40,0	63948
8,2 mm	0.3228			10,0	103,0	61,0	49,0	40,0	63949
8,3 mm	0.3268			10,0	103,0	61,0	49,0	40,0	63950
21/64	0.3281	8.33	3/8-20	10,0	103,0	61,0	49,0	40,0	51921
8,4 mm	0.3307			10,0	103,0	61,0	49,0	40,0	63951
Q	0.3320	8.43	3/8-24	10,0	103,0	61,0	49,0	40,0	51922
8,5 mm	0.3346		M10 X 1,5	10,0	103,0	61,0	49,0	40,0	63952
8,6 mm	0.3386			10,0	103,0	61,0	49,0	40,0	63953
8,7 mm	0.3425			10,0	103,0	61,0	49,0	40,0	63954

continued on next page



5xD

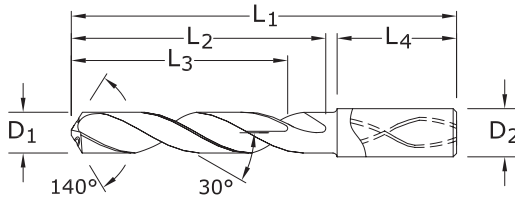

140 5xD

FRACTIONAL & METRIC SERIES

- Coolant through design promotes controlled and consistent operating temperatures improving coolant flow to the cut while maintaining strength
- Split point geometry for improved drill penetration and accuracy
- Controlled edge honing for longevity
- Negative corner position strengthens and protects
- Recommended for materials ≤ 60 HRc (≤ 654 Bhn)

CUTTING DIAMETER	DECIMAL EQUIV.	METRIC EQUIV.	TAP SIZE REFERENCE ONLY	mm					Ti-NAMITE-A (AlTiN)	EDP NO.
				SHANK DIAMETER	OVERALL LENGTH	FLUTE LENGTH	CLEARED LENGTH	SHANK LENGTH		
D ₁				D ₂	L ₁	L ₂	L ₃	L ₄		
11/32	0.3438	8.73	3/8-32	10,0	103,0	61,0	49,0	40,0	51923	
8,8 mm	0.3465		M10 X 1,25	10,0	103,0	61,0	49,0	40,0	63955	
8,9 mm	0.3504			10,0	103,0	61,0	49,0	40,0	63956	
9,0 mm	0.3543		M10 X 1	10,0	103,0	61,0	49,0	40,0	63957	
9,1 mm	0.3583			10,0	103,0	61,0	49,0	40,0	63958	
23/64	0.3594	9.13		10,0	103,0	61,0	49,0	40,0	51924	
9,2 mm	0.3622		M10 X 0,75	10,0	103,0	61,0	49,0	40,0	63959	
9,3 mm	0.3661			10,0	103,0	61,0	49,0	40,0	63960	
U	0.3680	9.35	7/16-14	10,0	103,0	61,0	49,0	40,0	51925	
9,4 mm	0.3701			10,0	103,0	61,0	49,0	40,0	63961	
9,5 mm	0.3740		M11 / M10 X 0,5	10,0	103,0	61,0	49,0	40,0	63962	
3/8	0.3750	9.53		10,0	103,0	61,0	49,0	40,0	51926	
9,6 mm	0.3780			10,0	103,0	61,0	49,0	40,0	63963	
9,7 mm	0.3819			10,0	103,0	61,0	49,0	40,0	63964	
9,8 mm	0.3858			10,0	103,0	61,0	49,0	40,0	63965	
9,9 mm	0.3898			10,0	103,0	61,0	49,0	40,0	63966	
25/64	0.3906	9.92	7/16-20	10,0	103,0	61,0	49,0	40,0	51927	
10,0 mm	0.3937			10,0	103,0	61,0	49,0	40,0	63967	
10,1 mm	0.3976			12,0	118,0	71,0	56,0	45,0	63968	
10,2 mm	0.4016		M12 X 1,75	12,0	118,0	71,0	56,0	45,0	63969	
10,3 mm	0.4055			12,0	118,0	71,0	56,0	45,0	63970	
13/32	0.4062	10.32		12,0	118,0	71,0	56,0	45,0	51928	
10,4 mm	0.4094			12,0	118,0	71,0	56,0	45,0	63971	
10,5 mm	0.4134		M12 X 1,5	12,0	118,0	71,0	56,0	45,0	63972	
10,6 mm	0.4173			12,0	118,0	71,0	56,0	45,0	63973	
10,7 mm	0.4213			12,0	118,0	71,0	56,0	45,0	63974	
27/64	0.4219	10.72	1/2-13	12,0	118,0	71,0	56,0	45,0	51929	
10,8 mm	0.4252		M12 X 1,25	12,0	118,0	71,0	56,0	45,0	63975	
10,9 mm	0.4291			12,0	118,0	71,0	56,0	45,0	63976	
11,0 mm	0.4331		M12 X 1	12,0	118,0	71,0	56,0	45,0	63977	
11,1 mm	0.4370			12,0	118,0	71,0	56,0	45,0	63978	
7/16	0.4375	11.11	1/4-18NPT	12,0	118,0	71,0	56,0	45,0	51930	
11,2 mm	0.4409			12,0	118,0	71,0	56,0	45,0	63979	
11,3 mm	0.4449			12,0	118,0	71,0	56,0	45,0	63980	

TOLERANCES (inch)

≤.1181 DIAMETER

D₁ = +.00008/+0.00047

D₂ = h₆

>.1181-.2362 DIAMETER

D₁ = +.00016/+0.00063

D₂ = h₆

>.2362-.3937 DIAMETER

D₁ = +.00024/+0.00083

D₂ = h₆

>.3937-.7087 DIAMETER

D₁ = +.00028/+0.00098

D₂ = h₆

>.7087-1.1811 DIAMETER

D₁ = +.00031/+0.00114

D₂ = h₆

TOLERANCES (mm)

≤3 DIAMETER

D₁ = +0,002/+0,012

D₂ = h₆

>3-6 DIAMETER

D₁ = +0,004/+0,016

D₂ = h₆

>6-10 DIAMETER

D₁ = +0,006/+0,021

D₂ = h₆

>10-18 DIAMETER

D₁ = +0,007/+0,025

D₂ = h₆

STEELS

STAINLESS STEELS

CAST IRON

HIGH TEMP ALLOYS

TITANIUM

NON-FERROUS

HARDENED STEELS

For patent information visit www.ksptpatents.com

continued on next page

140 5xD

FRACTIONAL & METRIC SERIES

CONTINUED

CUTTING DIAMETER	DECIMAL EQUIV.	METRIC EQUIV.	TAP SIZE REFERENCE ONLY	mm					Ti-NAMITE-A (AITiN) EDP NO.
				SHANK DIAMETER	OVERALL LENGTH	FLUTE LENGTH	CLEARED LENGTH	SHANK LENGTH	
D ₁				D ₂	L ₁	L ₂	L ₃	L ₄	
11,4 mm	0.4488			12,0	118,0	71,0	56,0	45,0	63981
11,5 mm	0.4528		M12 X 0,5	12,0	118,0	71,0	56,0	45,0	64000
11,6 mm	0.4567			12,0	118,0	71,0	56,0	45,0	63982
11,7 mm	0.4606			12,0	118,0	71,0	56,0	45,0	63983
11,8 mm	0.4646			12,0	118,0	71,0	56,0	45,0	63984
11,9 mm	0.4685			12,0	118,0	71,0	56,0	45,0	63985
15/32	0.4688	11.91	1/2-28	12,0	118,0	71,0	56,0	45,0	51932
12,0 mm	0.4724		M14 X 2	12,0	118,0	71,0	56,0	45,0	63986
31/64	0.4844	12.30	9/16-12	14,0	124,0	77,0	60,0	45,0	51933
12,5 mm	0.4921		M14 X 1,5	14,0	124,0	77,0	60,0	45,0	63987
1/2	0.5000	12.70		14,0	124,0	77,0	60,0	45,0	51934
12,8 mm	0.5039		M14 X 1,25	14,0	124,0	77,0	60,0	45,0	63988
13,0 mm	0.5118		M14 X 1	14,0	124,0	77,0	60,0	45,0	63989
33/64	0.5156	13.10	9/16-18	14,0	124,0	77,0	60,0	45,0	51935
13,5 mm	0.5315		5/8-11	14,0	124,0	77,0	60,0	45,0	64001
13,8 mm	0.5433			14,0	124,0	77,0	60,0	45,0	63990
14,0 mm	0.5512		M16 X 2	14,0	124,0	77,0	60,0	45,0	63991
9/16	0.5625	14.29		16,0	133,0	83,0	63,0	48,0	51937
14,5 mm	0.5709		M16 X 1,5	16,0	133,0	83,0	63,0	48,0	63992
37/64	0.5781	14.68	5/8-18	16,0	133,0	83,0	63,0	48,0	51938
14,8 mm	0.5827			16,0	133,0	83,0	63,0	48,0	63993
15,0 mm	0.5906		M16 X 1	16,0	133,0	83,0	63,0	48,0	63994
15,5 mm	0.6102		M18 X 2,5	16,0	133,0	83,0	63,0	48,0	63995
15,8 mm	0.6220			16,0	133,0	83,0	63,0	48,0	63996
5/8	0.6250	15.88	11/16-16	16,0	133,0	83,0	63,0	48,0	51939
16,0 mm	0.6299			16,0	133,0	83,0	63,0	48,0	63997
21/32	0.6562	16.67	3/4-10	18,0	143,0	93,0	71,0	48,0	51940
11/16	0.6875	17.46	3/4-16	18,0	143,0	93,0	71,0	48,0	51941
3/4	0.7500	19.05	13/16-16	20,0	153,0	101,0	77,0	50,0	51942

Series 140 5D Fractional	Hardness	Vc (sfm)	Diameter (D ₁) (inch)								
			1/8	3/16	1/4	3/8	1/2	5/8	3/4		
P CARBON STEELS 1018, 1040, 1080, 1090, 10L50, 1140, 1212, 12L15, 1525, 1536	≤ 175 Bhn or ≤ 7 HRc	425 (340-510)	RPM	12988	8659	6494	4329	3247	2598	2165	
			Fr	0.0039	0.0059	0.0079	0.0118	0.0157	0.0196	0.0236	
			Feed (ipm)	51.0	51.0	51.0	51.0	51.0	51.0	51.0	
	≤ 275 Bhn or ≤ 28 HRc	380 (304-456)	RPM	11613	7742	5806	3871	2903	2323	1935	
			Fr	0.0035	0.0053	0.0071	0.0106	0.0141	0.0177	0.0212	
			Feed (ipm)	41.0	41.0	41.0	41.0	41.0	41.0	41.0	
	≤ 425 Bhn or ≤ 45 HRc	220 (176-264)	RPM	6723	4482	3362	2241	1681	1345	1121	
			Fr	0.0030	0.0045	0.0059	0.0089	0.0119	0.0149	0.0178	
			Feed (ipm)	20.0	20.0	20.0	20.0	20.0	20.0	20.0	
	H ALLOY STEELS 4140, 4150, 4320, 5120, 5150, 8630, 86L20, 50100	≤ 275 Bhn or ≤ 28 HRc	330 (264-396)	RPM	10085	6723	5042	3362	2521	2017	1681
				Fr	0.0030	0.0045	0.0059	0.0089	0.0119	0.0149	0.0178
				Feed (ipm)	30.0	30.0	30.0	30.0	30.0	30.0	30.0
≤ 375 Bhn or ≤ 40 HRc		200 (160-240)	RPM	6112	4075	3056	2037	1528	1222	1019	
			Fr	0.0025	0.0038	0.0051	0.0076	0.0101	0.0127	0.0152	
			Feed (ipm)	15.5	15.5	15.5	15.5	15.5	15.5	15.5	
≤ 450 Bhn or ≤ 48 HRc		140 (112-168)	RPM	4278	2852	2139	1426	1070	856	713	
			Fr	0.0018	0.0027	0.0036	0.0054	0.0072	0.0090	0.0108	
			Feed (ipm)	7.7	7.7	7.7	7.7	7.7	7.7	7.7	
K TOOL STEELS A2, D2, H13, L2, M2, P20, S7, T15, W2		≤ 200 Bhn or ≤ 13 HRc	145 (116-174)	RPM	4431	2954	2216	1477	1108	886	739
				Fr	0.0026	0.0039	0.0052	0.0078	0.0104	0.0130	0.0156
				Feed (ipm)	11.5	11.5	11.5	11.5	11.5	11.5	11.5
	≤ 375 Bhn or ≤ 40 HRc	95 (76-114)	RPM	2903	1935	1452	968	726	581	484	
			Fr	0.0012	0.0018	0.0024	0.0036	0.0048	0.0060	0.0072	
			Feed (ipm)	3.5	3.5	3.5	3.5	3.5	3.5	3.5	
	≤ 475 Bhn or ≤ 50 HRc	85 (68-102)	RPM	2598	1732	1299	866	649	520	433	
			Fr	0.0008	0.0012	0.0015	0.0023	0.0031	0.0038	0.0046	
			Feed (ipm)	2.0	2.0	2.0	2.0	2.0	2.0	2.0	
	M CAST IRONS Gray, Malleable, Ductile	≤ 220 Bhn or ≤ 19 HRc	360 (288-432)	RPM	11002	7334	5501	3667	2750	2200	1834
				Fr	0.0045	0.0068	0.0091	0.0136	0.0182	0.0227	0.0273
				Feed (ipm)	50.0	50.0	50.0	50.0	50.0	50.0	50.0
≤ 260 Bhn or ≤ 26 HRc		335 (268-402)	RPM	10238	6825	5119	3413	2559	2048	1706	
			Fr	0.0045	0.0068	0.0091	0.0136	0.0182	0.0227	0.0273	
			Feed (ipm)	46.5	46.5	46.5	46.5	46.5	46.5	46.5	
M STAINLESS STEELS (FREE MACHINING) 303, 416, 420F, 430F, 440F		≤ 185 Bhn or ≤ 9 HRc	305 (244-366)	RPM	9321	6214	4660	3107	2330	1864	1553
				Fr	0.0026	0.0039	0.0051	0.0077	0.0103	0.0129	0.0154
				Feed (ipm)	24.0	24.0	24.0	24.0	24.0	24.0	24.0
		≤ 275 Bhn or ≤ 28 HRc	195 (156-234)	RPM	5959	3973	2980	1986	1490	1192	993
				Fr	0.0020	0.0030	0.0040	0.0060	0.0081	0.0101	0.0121
				Feed (ipm)	12.0	12.0	12.0	12.0	12.0	12.0	12.0
	≤ 275 Bhn or ≤ 28 HRc	150 (120-180)	RPM	4584	3056	2292	1528	1146	917	764	
			Fr	0.0020	0.0030	0.0040	0.0060	0.0079	0.0099	0.0119	
			Feed (ipm)	9.1	9.1	9.1	9.1	9.1	9.1	9.1	
	≤ 375 Bhn or ≤ 40 HRc	110 (88-132)	RPM	3362	2241	1681	1121	840	672	560	
			Fr	0.0018	0.0027	0.0036	0.0054	0.0071	0.0089	0.0107	
			Feed (ipm)	6.0	6.0	6.0	6.0	6.0	6.0	6.0	
STAINLESS STEELS (DIFFICULT) 304, 316, 321, 13-8 PH, 15-5PH, 17-4 PH, Custom 450			RPM								
			Fr								
			Feed (ipm)								

continued on next page

Series	Hardness	Vc (sfm)	Diameter (D ₁) (inch)									
			1/8	3/16	1/4	3/8	1/2	5/8	3/4			
140 5D Fractional	SUPER ALLOYS (NICKEL, COBALT, IRON BASE) Inconel 601, 617, 625, Incoloy, Monel 400, Rene, Waspaloy	≤ 300 Bhn or ≤ 32 HRc	95 (76-114)	RPM	2903	1935	1452	968	726	581	484	
				Fr	0.0008	0.0012	0.0016	0.0024	0.0032	0.0040	0.0048	
				Feed (ipm)	2.3	2.3	2.3	2.3	2.3	2.3	2.3	
		≤ 400 Bhn or ≤ 43 HRc	50 (40-60)	RPM	1528	1019	764	509	382	306	255	
				Fr	0.0007	0.0010	0.0013	0.0020	0.0026	0.0033	0.0039	
				Feed (ipm)	1.0	1.0	1.0	1.0	1.0	1.0	1.0	
	S	TITANIUM ALLOYS Pure Titanium, Ti6Al4V, Ti6Al2Sn4Zr2Mo, Ti4Al4Mo2Sn0.5Si, Ti-6Al4V	≤ 275 Bhn or ≤ 28 HRc	215 (172-258)	RPM	6570	4380	3285	2190	1643	1314	1095
					Fr	0.0018	0.0026	0.0035	0.0053	0.0070	0.0088	0.0105
					Feed (ipm)	11.5	11.5	11.5	11.5	11.5	11.5	11.5
			≤ 350 Bhn or ≤ 38 HRc	160 (128-192)	RPM	4890	3260	2445	1630	1222	978	815
					Fr	0.0016	0.0024	0.0032	0.0048	0.0064	0.0080	0.0096
					Feed (ipm)	7.8	7.8	7.8	7.8	7.8	7.8	7.8
N		ALUMINUM ALLOYS 2017, 2024, 356, 6061, 7075	≤ 440 Bhn or ≤ 47 HRc	85 (68-102)	RPM	2598	1732	1299	866	649	520	433
					Fr	0.0012	0.0018	0.0024	0.0036	0.0048	0.0060	0.0072
					Feed (ipm)	3.1	3.1	3.1	3.1	3.1	3.1	3.1
			≤ 80 Bhn or ≤ 47 HRb	770 (616-924)	RPM	23531	15687	11766	7844	5883	4706	3922
					Fr	0.0049	0.0073	0.0098	0.0147	0.0195	0.0244	0.0293
					Feed (ipm)	115.0	115.0	115.0	115.0	115.0	115.0	115.0
N	COPPER ALLOYS Alum Bronze, C110, Muntz Brass	≤ 150 Bhn or ≤ 7 HRc	660 (528-792)	RPM	20170	13446	10085	6723	5042	4034	3362	
				Fr	0.0050	0.0074	0.0099	0.0149	0.0198	0.0248	0.0297	
				Feed (ipm)	100.0	100.0	100.0	100.0	100.0	100.0	100.0	
		≤ 140 Bhn or ≤ 3 HRc	550 (440-660)	RPM	16808	11205	8404	5603	4202	3362	2801	
				Fr	0.0020	0.0030	0.0040	0.0060	0.0080	0.0100	0.0120	
				Feed (ipm)	33.5	33.5	33.5	33.5	33.5	33.5	33.5	
N	COPPER ALLOYS Alum Bronze, C110, Muntz Brass	≤ 200 Bhn or ≤ 23 HRc	440 (352-528)	RPM	13446	8964	6723	4482	3362	2689	2241	
				Fr	0.0020	0.0030	0.0040	0.0060	0.0080	0.0100	0.0120	
				Feed (ipm)	27.0	27.0	27.0	27.0	27.0	27.0	27.0	

Bhn (Brinell) HRc (Rockwell C) HRb (Rockwell B)

rpm = Vc x 3.82 / D₁

ipm = Fr x rpm

reduce speed and feed for materials harder than listed

refer to the KYOCERA SGS Tool Wizard® for complete technical information (www.kyocera-sgstool.com)

Series 140M 5D Metric	Hardness	Vc (m/min)	Diameter (D ₁) (mm)								
			3	6	8	10	12	14	16		
P CARBON STEELS 1018, 1040, 1080, 1090, 10L50, 1140, 1212, 12L15, 1525, 1536	≤ 175 Bhn or ≤ 7 HRc	130 (104-155)	RPM	13733	6867	5150	4120	3433	2943	2575	
			Fr	0.095	0.189	0.252	0.316	0.379	0.442	0.505	
			Feed (mm/min)	1300	1300	1300	1300	1300	1300	1300	
	≤ 275 Bhn or ≤ 28 HRc	116 (93-139)	RPM	12279	6140	4605	3684	3070	2631	2302	
			Fr	0.086	0.171	0.228	0.285	0.342	0.399	0.456	
			Feed (mm/min)	1050	1050	1050	1050	1050	1050	1050	
	≤ 425 Bhn or ≤ 45 HRc	67 (54-80)	RPM	7109	3555	2666	2133	1777	1523	1333	
			Fr	0.071	0.142	0.189	0.237	0.284	0.332	0.379	
			Feed (mm/min)	505	505	505	505	505	505	505	
	H ALLOY STEELS 4140, 4150, 4320, 5120, 5150, 8630, 86L20, 50100	≤ 275 Bhn or ≤ 28 HRc	101 (80-121)	RPM	10664	5332	3999	3199	2666	2285	1999
				Fr	0.071	0.143	0.190	0.238	0.285	0.333	0.380
				Feed (mm/min)	760	760	760	760	760	760	760
≤ 375 Bhn or ≤ 40 HRc		61 (49-73)	RPM	6463	3231	2424	1939	1616	1385	1212	
			Fr	0.062	0.124	0.165	0.206	0.248	0.289	0.330	
			Feed (mm/min)	400	400	400	400	400	400	400	
≤ 450 Bhn or ≤ 48 HRc		43 (34-51)	RPM	4524	2262	1696	1357	1131	969	848	
			Fr	0.043	0.086	0.115	0.144	0.172	0.201	0.230	
			Feed (mm/min)	195	195	195	195	195	195	195	
K TOOL STEELS A2, D2, H13, L2, M2, P20, S7, T15, W2		≤ 200 Bhn or ≤ 13 HRc	44 (35-53)	RPM	4686	2343	1757	1406	1171	1004	879
				Fr	0.061	0.122	0.162	0.203	0.243	0.284	0.324
				Feed (mm/min)	285	285	285	285	285	285	285
	≤ 375 Bhn or ≤ 40 HRc	29 (23-35)	RPM	3070	1535	1151	921	767	658	576	
			Fr	0.029	0.059	0.078	0.098	0.117	0.137	0.156	
			Feed (mm/min)	90	90	90	90	90	90	90	
	≤ 475 Bhn or ≤ 50 HRc	26 (21-31)	RPM	2747	1373	1030	824	687	589	515	
			Fr	0.018	0.036	0.049	0.061	0.073	0.085	0.097	
			Feed (mm/min)	50	50	50	50	50	50	50	
	M CAST IRONS Gray, Malleable, Ductile	≤ 220 Bhn or ≤ 19 HRc	110 (88-132)	RPM	11633	5816	4362	3490	2908	2493	2181
				Fr	0.109	0.218	0.291	0.364	0.437	0.509	0.582
				Feed (mm/min)	1270	1270	1270	1270	1270	1270	1270
≤ 260 Bhn or ≤ 26 HRc		102 (82-123)	RPM	10825	5413	4059	3248	2706	2320	2030	
			Fr	0.109	0.218	0.291	0.363	0.436	0.509	0.581	
			Feed (mm/min)	1180	1180	1180	1180	1180	1180	1180	
M STAINLESS STEELS (FREE MACHINING) 303, 416, 420F, 430F, 440F		≤ 185 Bhn or ≤ 9 HRc	93 (74-112)	RPM	9856	4928	3696	2957	2464	2112	1848
				Fr	0.061	0.123	0.164	0.205	0.246	0.286	0.327
				Feed (mm/min)	605	605	605	605	605	605	605
		≤ 275 Bhn or ≤ 28 HRc	59 (48-71)	RPM	6301	3151	2363	1890	1575	1350	1181
				Fr	0.048	0.095	0.127	0.159	0.190	0.222	0.254
				Feed (mm/min)	300	300	300	300	300	300	300
	M STAINLESS STEELS (DIFFICULT) 304, 316, 321, 13-8 PH, 15-5PH, 17-4 PH, Custom 450	≤ 275 Bhn or ≤ 28 HRc	46 (37-55)	RPM	4847	2424	1818	1454	1212	1039	909
				Fr	0.047	0.095	0.127	0.158	0.190	0.221	0.253
				Feed (mm/min)	230	230	230	230	230	230	230
		≤ 375 Bhn or ≤ 40 HRc	34 (27-40)	RPM	3555	1777	1333	1066	889	762	666
				Fr	0.042	0.084	0.113	0.141	0.169	0.197	0.225
				Feed (mm/min)	150	150	150	150	150	150	150

continued on next page

Series 140M 5D Metric	Hardness	Vc (m/min)	Diameter (D ₁) (mm)								
			3	6	8	10	12	14	16		
SUPER ALLOYS (NICKEL, COBALT, IRON BASE) Inconel 601, 617, 625, Incoloy, Monel 400, Rene, Waspaloy	≤ 300 Bhn or ≤ 32 HRc	29	RPM	3070	1535	1151	921	767	658	576	
		(23-35)	Fr	0.020	0.039	0.052	0.065	0.078	0.091	0.104	
			Feed (mm/min)	60	60	60	60	60	60	60	
	≤ 400 Bhn or ≤ 43 HRc	15	RPM	1616	808	606	485	404	346	303	
		(12-18)	Fr	0.015	0.031	0.041	0.052	0.062	0.072	0.083	
			Feed (mm/min)	25	25	25	25	25	25	25	
	S	≤ 275 Bhn or ≤ 28 HRc	66	RPM	6947	3474	2605	2084	1737	1489	1303
			(52-79)	Fr	0.040	0.079	0.106	0.132	0.158	0.185	0.211
				Feed (mm/min)	275	275	275	275	275	275	275
		≤ 350 Bhn or ≤ 38 HRc	49	RPM	5170	2585	1939	1551	1293	1108	969
			(39-59)	Fr	0.039	0.077	0.103	0.129	0.155	0.181	0.206
				Feed (mm/min)	200	200	200	200	200	200	200
≤ 440 Bhn or ≤ 47 HRc		26	RPM	2747	1373	1030	824	687	589	515	
		(21-31)	Fr	0.029	0.058	0.078	0.097	0.117	0.136	0.155	
			Feed (mm/min)	80	80	80	80	80	80	80	
N		≤ 80 Bhn or ≤ 47 HRb	235	RPM	24882	12441	9331	7465	6220	5332	4665
			(188-282)	Fr	0.118	0.237	0.316	0.395	0.473	0.552	0.631
				Feed (mm/min)	2945	2945	2945	2945	2945	2945	2945
	≤ 150 Bhn or ≤ 7 HRc	201	RPM	21327	10664	7998	6398	5332	4570	3999	
		(161-241)	Fr	0.119	0.238	0.318	0.397	0.476	0.556	0.635	
			Feed (mm/min)	2540	2540	2540	2540	2540	2540	2540	
	≤ 140 Bhn or ≤ 3 HRc	168	RPM	17773	8886	6665	5332	4443	3808	3332	
		(134-201)	Fr	0.048	0.096	0.128	0.159	0.191	0.223	0.255	
			Feed (mm/min)	850	850	850	850	850	850	850	
	COPPER ALLOYS Alum Bronze, C110, Muntz Brass	≤ 200 Bhn or ≤ 23 HRc	134	RPM	14218	7109	5332	4265	3555	3047	2666
			(107-161)	Fr	0.048	0.096	0.128	0.161	0.193	0.225	0.257
				Feed (mm/min)	685	685	685	685	685	685	685

Bhn (Brinell) HRc (Rockwell C) HRb (Rockwell B)

$$\text{rpm} = (\text{Vc} \times 1000) / (\text{D}_1 \times 3.14)$$

$$\text{mm/min} = \text{Fr} \times \text{rpm}$$

reduce speed and feed for materials harder than listed

refer to the KYOCERA SGS Tool Wizard® for complete technical information (www.kyocera-sgstool.com)



8xD



2

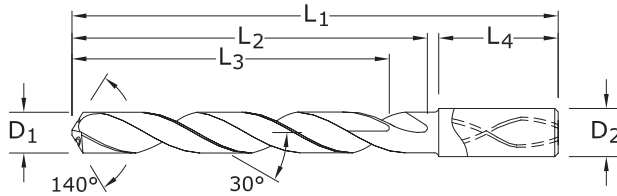

140 8xD

FRACTIONAL & METRIC SERIES

- Coolant through design promotes controlled and consistent operating temperatures improving coolant flow to the cut while maintaining strength
- Split point geometry for improved drill penetration and accuracy
- Controlled edge honing for longevity
- Negative corner position strengthens and protects
- Recommended for materials ≤ 60 HRc (≤ 654 Bhn)

CUTTING DIAMETER	DECIMAL EQUIV.	METRIC EQUIV.	TAP SIZE REFERENCE ONLY	mm					Ti-NAMITE-A (AlTiN)
				SHANK DIAMETER	OVERALL LENGTH	FLUTE LENGTH	CLEARED LENGTH	SHANK LENGTH	
D ₁				D ₂	L ₁	L ₂	L ₃	L ₄	EDP NO.
3,0 mm	0.1181			6,0	72,0	34,0	29,0	36,0	63575
3,1 mm	0.1220			6,0	72,0	34,0	29,0	36,0	63576
1/8	0.1250	3.18		6,0	72,0	34,0	29,0	36,0	51801
3,2 mm	0.1260		M3,5 X 0,35	6,0	72,0	34,0	29,0	36,0	63577
3,3 mm	0.1299		M4 X 0,7	6,0	72,0	34,0	29,0	36,0	63578
3,4 mm	0.1339			6,0	72,0	34,0	29,0	36,0	63579
#29	0.1360	3.45	8-32,8-36	6,0	72,0	34,0	29,0	36,0	51802
3,5 mm	0.1378		M4 X 0,5	6,0	72,0	34,0	29,0	36,0	63580
9/64	0.1406	3.57		6,0	72,0	34,0	29,0	36,0	51803
3,6 mm	0.1417		M4 X 0,35	6,0	72,0	34,0	29,0	36,0	63581
3,7 mm	0.1457		M4,5 X 0,75	6,0	72,0	34,0	29,0	36,0	63582
3,8 mm	0.1496		10-24	6,0	81,0	43,0	36,0	36,0	63583
3,9 mm	0.1535			6,0	81,0	43,0	36,0	36,0	63584
5/32	0.1562	3.97		6,0	81,0	43,0	36,0	36,0	51804
4,0 mm	0.1575		M4,5 X 0,5	6,0	81,0	43,0	36,0	36,0	63585
#21	0.1590	4.04	10-32	6,0	81,0	43,0	36,0	36,0	51805
4,1 mm	0.1614			6,0	81,0	43,0	36,0	36,0	63586
4,2 mm	0.1654		M5 / M5 X 0,75	6,0	81,0	43,0	36,0	36,0	63587
4,3 mm	0.1693			6,0	81,0	43,0	36,0	36,0	63588
11/64	0.1719	4.37		6,0	81,0	43,0	36,0	36,0	51806
4,4 mm	0.1732		12-24	6,0	81,0	43,0	36,0	36,0	63589
4,5 mm	0.1772		M5 X 0,5	6,0	81,0	43,0	36,0	36,0	63590
4,6 mm	0.1811		12-28	6,0	81,0	43,0	36,0	36,0	63591
4,7 mm	0.1850		12-32	6,0	81,0	43,0	36,0	36,0	63592
3/16	0.1875	4.76		6,0	95,0	57,0	48,0	36,0	51807
4,8 mm	0.1890		7/32-32	6,0	95,0	57,0	48,0	36,0	63593
4,9 mm	0.1929			6,0	95,0	57,0	48,0	36,0	63594
5,0 mm	0.1969		M6 X 1	6,0	95,0	57,0	48,0	36,0	63595
5,1 mm	0.2008		1/4-20	6,0	95,0	57,0	48,0	36,0	63596
13/64	0.2031	5.16		6,0	95,0	57,0	48,0	36,0	51808
5,2 mm	0.2047		M6 X 0,75	6,0	95,0	57,0	48,0	36,0	63597
5,3 mm	0.2087			6,0	95,0	57,0	48,0	36,0	63598
5,4 mm	0.2126			6,0	95,0	57,0	48,0	36,0	63599
5,5 mm	0.2165		M6 X 0,5	6,0	95,0	57,0	48,0	36,0	63600

TOLERANCES (inch)

- ≤.1181 DIAMETER
D₁ = +.00008/+0.00047
D₂ = h₆
- >.1181-.2362 DIAMETER
D₁ = +.00016/+0.00063
D₂ = h₆
- >.2362-.3937 DIAMETER
D₁ = +.00024/+0.00083
D₂ = h₆
- >.3937-.7087 DIAMETER
D₁ = +.00028/+0.00098
D₂ = h₆
- >.7087-1.1811 DIAMETER
D₁ = +.00031/+0.00114
D₂ = h₆

TOLERANCES (mm)

- ≤3 DIAMETER
D₁ = +0,002/+0,012
D₂ = h₆
- >3-6 DIAMETER
D₁ = +0,004/+0,016
D₂ = h₆
- >6-10 DIAMETER
D₁ = +0,006/+0,021
D₂ = h₆
- >10-18 DIAMETER
D₁ = +0,007/+0,025
D₂ = h₆

- STEELS
- STAINLESS STEELS
- CAST IRON
- HIGH TEMP ALLOYS
- TITANIUM
- NON-FERROUS
- HARDENED STEELS

For patent information visit www.ksptpatents.com

continued on next page

140 8xD

FRACTIONAL & METRIC SERIES

CONTINUED

CUTTING DIAMETER	DECIMAL EQUIV.	METRIC EQUIV.	TAP SIZE REFERENCE ONLY	mm					Ti-NAMITE-A (AITiN) EDP NO.
				SHANK DIAMETER	OVERALL LENGTH	FLUTE LENGTH	CLEARED LENGTH	SHANK LENGTH	
D ₁				D ₂	L ₁	L ₂	L ₃	L ₄	
7/32	0.2188	5.56	1/4-32	6,0	95,0	57,0	48,0	36,0	51809
5,6 mm	0.2205			6,0	95,0	57,0	48,0	36,0	63601
5,7 mm	0.2244			6,0	95,0	57,0	48,0	36,0	63602
5,8 mm	0.2283			6,0	95,0	57,0	48,0	36,0	63603
5,9 mm	0.2323			6,0	95,0	57,0	48,0	36,0	63604
15/64	0.2344	5.95		6,0	95,0	57,0	48,0	36,0	51810
6,0 mm	0.2362		M7 X 1	6,0	95,0	57,0	48,0	36,0	63605
6,1 mm	0.2402			8,0	114,0	76,0	64,0	36,0	63606
6,2 mm	0.2441		M7 X 0,75	8,0	114,0	76,0	64,0	36,0	63607
6,3 mm	0.2480			8,0	114,0	76,0	64,0	36,0	63608
1/4	0.2500	6.35		8,0	114,0	76,0	64,0	36,0	51811
6,4 mm	0.2520			8,0	114,0	76,0	64,0	36,0	63609
6,5 mm	0.2559			8,0	114,0	76,0	64,0	36,0	63610
F	0.2570	6.53	5/16-18	8,0	114,0	76,0	64,0	36,0	51812
6,6 mm	0.2598			8,0	114,0	76,0	64,0	36,0	63611
6,7 mm	0.2638			8,0	114,0	76,0	64,0	36,0	63612
17/64	0.2656	6.75	5/16-20	8,0	114,0	76,0	64,0	36,0	51813
6,8 mm	0.2677		M8 X 1,25	8,0	114,0	76,0	64,0	36,0	63613
6,9 mm	0.2717			8,0	114,0	76,0	64,0	36,0	63614
7,0 mm	0.2756		M8 X 1	8,0	114,0	76,0	64,0	36,0	63615
7,1 mm	0.2795			8,0	114,0	76,0	64,0	36,0	63616
9/32	0.2812	7.14	5/16-32	8,0	114,0	76,0	64,0	36,0	51814
7,2 mm	0.2835		M8 X 0,75	8,0	114,0	76,0	64,0	36,0	63617
7,3 mm	0.2874			8,0	114,0	76,0	64,0	36,0	63618
7,4 mm	0.2913			8,0	114,0	76,0	64,0	36,0	63619
7,5 mm	0.2953		M8 X 0,5	8,0	114,0	76,0	64,0	36,0	63620
19/64	0.2969	7.54		8,0	114,0	76,0	64,0	36,0	51815
7,6 mm	0.2992			8,0	114,0	76,0	64,0	36,0	63621
7,7 mm	0.3031			8,0	114,0	76,0	64,0	36,0	63622
7,8 mm	0.3071		M9 X 1,25	8,0	114,0	76,0	64,0	36,0	63623
7,9 mm	0.3110			8,0	114,0	76,0	64,0	36,0	63624
5/16	0.3125	7.94	3/8-16	8,0	114,0	76,0	64,0	36,0	51816
8,0 mm	0.3150		M9 X 1	8,0	114,0	76,0	64,0	36,0	63625
8,1 mm	0.3189			10,0	142,0	95,0	80,0	40,0	63626
8,2 mm	0.3228			10,0	142,0	95,0	80,0	40,0	63627
8,3 mm	0.3268			10,0	142,0	95,0	80,0	40,0	63628
21/64	0.3281	8.33	3/8-20	10,0	142,0	95,0	80,0	40,0	51817
8,4 mm	0.3307			10,0	142,0	95,0	80,0	40,0	63629
Q	0.3320	8.43	3/8-24	10,0	142,0	95,0	80,0	40,0	51818
8,5 mm	0.3346		M10 X 1,5	10,0	142,0	95,0	80,0	40,0	63630
8,6 mm	0.3386			10,0	142,0	95,0	80,0	40,0	63631
8,7 mm	0.3425			10,0	142,0	95,0	80,0	40,0	63632

continued on next page



8xD



2

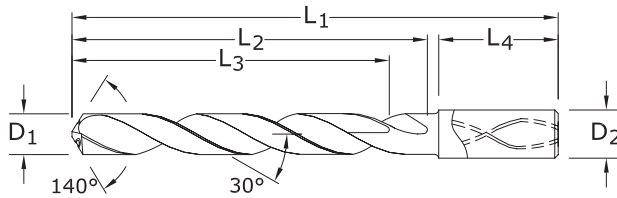

140 8xD

FRACTIONAL & METRIC SERIES

- Coolant through design promotes controlled and consistent operating temperatures improving coolant flow to the cut while maintaining strength
- Split point geometry for improved drill penetration and accuracy
- Controlled edge honing for longevity
- Negative corner position strengthens and protects
- Recommended for materials ≤ 60 HRc (≤ 654 Bhn)

CUTTING DIAMETER	DECIMAL EQUIV.	METRIC EQUIV.	TAP SIZE REFERENCE ONLY	mm					Ti-NAMITE-A (AITiN)	EDP NO.
				SHANK DIAMETER	OVERALL LENGTH	FLUTE LENGTH	CLEARED LENGTH	SHANK LENGTH		
D ₁				D ₂	L ₁	L ₂	L ₃	L ₄		
11/32	0.3438	8.73	3/8-32	10,0	142,0	95,0	80,0	40,0	51819	
8,8 mm	0.3465		M10 X 1,25	10,0	142,0	95,0	80,0	40,0	63633	
8,9 mm	0.3504			10,0	142,0	95,0	80,0	40,0	63634	
9,0 mm	0.3543		M10 X 1	10,0	142,0	95,0	80,0	40,0	63635	
9,1 mm	0.3583			10,0	142,0	95,0	80,0	40,0	63636	
23/64	0.3594	9.13		10,0	142,0	95,0	80,0	40,0	51820	
9,2 mm	0.3622		M10 X 0,75	10,0	142,0	95,0	80,0	40,0	63637	
9,3 mm	0.3661			10,0	142,0	95,0	80,0	40,0	63638	
U	0.3680	9.35	7/16-14	10,0	142,0	95,0	80,0	40,0	51821	
9,4 mm	0.3701			10,0	142,0	95,0	80,0	40,0	63639	
9,5 mm	0.3740		M11 / M10 X 0,5	10,0	142,0	95,0	80,0	40,0	63640	
3/8	0.3750	9.53		10,0	142,0	95,0	80,0	40,0	51822	
9,6 mm	0.3780			10,0	142,0	95,0	80,0	40,0	63641	
9,7 mm	0.3819			10,0	142,0	95,0	80,0	40,0	63642	
9,8 mm	0.3858			10,0	142,0	95,0	80,0	40,0	63643	
9,9 mm	0.3898			10,0	142,0	95,0	80,0	40,0	63644	
25/64	0.3906	9.92	7/16-20	10,0	142,0	95,0	80,0	40,0	51823	
10,0 mm	0.3937			10,0	142,0	95,0	80,0	40,0	63645	
10,1 mm	0.3976			12,0	162,0	114,0	96,0	45,0	63646	
10,2 mm	0.4016		M12 X 1,75	12,0	162,0	114,0	96,0	45,0	63647	
10,3 mm	0.4055			12,0	162,0	114,0	96,0	45,0	63648	
13/32	0.4062	10.32		12,0	162,0	114,0	96,0	45,0	51824	
10,4 mm	0.4094			12,0	162,0	114,0	96,0	45,0	63649	
10,5 mm	0.4134		M12 X 1,5	12,0	162,0	114,0	96,0	45,0	63650	
10,6 mm	0.4173			12,0	162,0	114,0	96,0	45,0	63651	
10,7 mm	0.4213			12,0	162,0	114,0	96,0	45,0	63652	
27/64	0.4219	10.72	1/2-13	12,0	162,0	114,0	96,0	45,0	51825	
10,8 mm	0.4252		M12 X 1,25	12,0	162,0	114,0	96,0	45,0	63653	
10,9 mm	0.4291			12,0	162,0	114,0	96,0	45,0	63654	
11,0 mm	0.4331		M12 X 1	12,0	162,0	114,0	96,0	45,0	63655	
11,1 mm	0.4370			12,0	162,0	114,0	96,0	45,0	63656	
7/16	0.4375	11.11	1/4-18NPT	12,0	162,0	114,0	96,0	45,0	51826	

continued on next page

TOLERANCES (inch)

≤.1181 DIAMETER

D₁ = +.00008/+0.00047

D₂ = h₆

>.1181-.2362 DIAMETER

D₁ = +.00016/+0.00063

D₂ = h₆

>.2362-.3937 DIAMETER

D₁ = +.00024/+0.00083

D₂ = h₆

>.3937-.7087 DIAMETER

D₁ = +.00028/+0.00098

D₂ = h₆

>.7087-1.1811 DIAMETER

D₁ = +.00031/+0.00114

D₂ = h₆

TOLERANCES (mm)

≤3 DIAMETER

D₁ = +0,002/+0,012

D₂ = h₆

>3-6 DIAMETER

D₁ = +0,004/+0,016

D₂ = h₆

>6-10 DIAMETER

D₁ = +0,006/+0,021

D₂ = h₆

>10-18 DIAMETER

D₁ = +0,007/+0,025

D₂ = h₆

- STEELS
- STAINLESS STEELS
- CAST IRON
- HIGH TEMP ALLOYS
- TITANIUM
- NON-FERROUS
- HARDENED STEELS

For patent information visit www.ksptpatents.com

140 8xD

FRACTIONAL & METRIC SERIES

CONTINUED

CUTTING DIAMETER	DECIMAL EQUIV.	METRIC EQUIV.	TAP SIZE REFERENCE ONLY	mm					Ti-NAMITE-A (AITiN) EDP NO.
				SHANK DIAMETER	OVERALL LENGTH	FLUTE LENGTH	CLEARED LENGTH	SHANK LENGTH	
D ₁				D ₂	L ₁	L ₂	L ₃	L ₄	
11,2 mm	0.4409			12,0	162,0	114,0	96,0	45,0	63657
11,3 mm	0.4449			12,0	162,0	114,0	96,0	45,0	63658
11,4 mm	0.4488			12,0	162,0	114,0	96,0	45,0	63659
11,5 mm	0.4528		M12 X 0,5	12,0	162,0	114,0	96,0	45,0	63660
11,6 mm	0.4567			12,0	162,0	114,0	96,0	45,0	63661
11,7 mm	0.4606			12,0	162,0	114,0	96,0	45,0	63662
11,8 mm	0.4646			12,0	162,0	114,0	96,0	45,0	63663
11,9 mm	0.4685			12,0	162,0	114,0	96,0	45,0	63664
15/32	0.4688	11.91	1/2-28	12,0	162,0	114,0	96,0	45,0	51827
12,0 mm	0.4724		M14 X 2	12,0	162,0	114,0	96,0	45,0	63665
31/64	0.4844	12.30	9/16-12	14,0	178,0	133,0	112,0	45,0	51828
12,5 mm	0.4921		M14 X 1,5	14,0	178,0	133,0	112,0	45,0	63666
1/2	0.5000	12.70		14,0	178,0	133,0	112,0	45,0	51829
12,8 mm	0.5039		M14 X 1,25	14,0	178,0	133,0	112,0	45,0	63667
13,0 mm	0.5118		M14 X 1	14,0	178,0	133,0	112,0	45,0	63668
33/64	0.5156	13.10	9/16-18	14,0	178,0	133,0	112,0	45,0	51830
13,5 mm	0.5315		5/8-11	14,0	178,0	133,0	112,0	45,0	63669
13,8 mm	0.5433			14,0	178,0	133,0	112,0	45,0	63670
14,0 mm	0.5512		M16 X 2	14,0	178,0	133,0	112,0	45,0	63671
9/16	0.5625	14.29		16,0	203,0	152,0	128,0	48,0	51831
14,5 mm	0.5709		M16 X 1,5	16,0	203,0	152,0	128,0	48,0	63672
37/64	0.5781	14.68	5/8-18	16,0	203,0	152,0	128,0	48,0	51832
14,8 mm	0.5827			16,0	203,0	152,0	128,0	48,0	63673
15,0 mm	0.5906		M16 X 1	16,0	203,0	152,0	128,0	48,0	63674
15,5 mm	0.6102		M18 X 2,5	16,0	203,0	152,0	128,0	48,0	63675
15,8 mm	0.6220			16,0	203,0	152,0	128,0	48,0	63676
5/8	0.6250	15.88	11/16-16	16,0	203,0	152,0	128,0	48,0	51833
16,0 mm	0.6299			16,0	203,0	152,0	128,0	48,0	63677
21/32	0.6562	16.67	3/4-10	18,0	222,0	171,0	144,0	48,0	51834
11/16	0.6875	17.46	3/4-16	18,0	222,0	171,0	144,0	48,0	51835
3/4	0.7500	19.05	13/16-16	20,0	243,0	190,0	160,0	50,0	51836

Series 140 8D Fractional	Hardness	Vc (sfm)	Diameter (D ₁) (inch)								
			1/8	3/16	1/4	3/8	1/2	5/8	3/4		
P CARBON STEELS 1018, 1040, 1080, 1090, 10L50, 1140, 1212, 12L15, 1525, 1536	≤ 175 Bhn or ≤ 7 HRc	405 (324-486)	RPM	12377	8251	6188	4126	3094	2475	2063	
			Fr	0.0036	0.0053	0.0071	0.0107	0.0142	0.0178	0.0213	
			Feed (ipm)	44.0	44.0	44.0	44.0	44.0	44.0	44.0	
	≤ 275 Bhn or ≤ 28 HRc	370 (296-444)	RPM	11307	7538	5654	3769	2827	2261	1885	
			Fr	0.0030	0.0045	0.0060	0.0090	0.0120	0.0150	0.0180	
			Feed (ipm)	34.0	34.0	34.0	34.0	34.0	34.0	34.0	
	≤ 425 Bhn or ≤ 45 HRc	210 (168-252)	RPM	6418	4278	3209	2139	1604	1284	1070	
			Fr	0.0026	0.0039	0.0051	0.0077	0.0103	0.0129	0.0154	
			Feed (ipm)	16.5	16.5	16.5	16.5	16.5	16.5	16.5	
	H ALLOY STEELS 4140, 4150, 4320, 5120, 5150, 8630, 86L20, 50100	≤ 275 Bhn or ≤ 28 HRc	320 (256-384)	RPM	9779	6519	4890	3260	2445	1956	1630
				Fr	0.0026	0.0038	0.0051	0.0077	0.0102	0.0128	0.0153
				Feed (ipm)	25.0	25.0	25.0	25.0	25.0	25.0	25.0
≤ 375 Bhn or ≤ 40 HRc		190 (152-228)	RPM	5806	3871	2903	1935	1452	1161	968	
			Fr	0.0020	0.0030	0.0040	0.0059	0.0079	0.0099	0.0119	
			Feed (ipm)	11.5	11.5	11.5	11.5	11.5	11.5	11.5	
≤ 450 Bhn or ≤ 48 HRc		135 (108-162)	RPM	4126	2750	2063	1375	1031	825	688	
			Fr	0.0016	0.0024	0.0032	0.0047	0.0063	0.0079	0.0095	
			Feed (ipm)	6.5	6.5	6.5	6.5	6.5	6.5	6.5	
K TOOL STEELS A2, D2, H13, L2, M2, P20, S7, T15, W2		≤ 200 Bhn or ≤ 13 HRc	140 (112-168)	RPM	4278	2852	2139	1426	1070	856	713
				Fr	0.0020	0.0030	0.0040	0.0060	0.0079	0.0099	0.0119
				Feed (ipm)	8.5	8.5	8.5	8.5	8.5	8.5	8.5
	≤ 375 Bhn or ≤ 40 HRc	90 (72-108)	RPM	2750	1834	1375	917	688	550	458	
			Fr	0.0011	0.0016	0.0022	0.0033	0.0044	0.0055	0.0065	
			Feed (ipm)	3.0	3.0	3.0	3.0	3.0	3.0	3.0	
	≤ 475 Bhn or ≤ 50 HRc	80 (64-96)	RPM	2445	1630	1222	815	611	489	407	
			Fr	0.0006	0.0009	0.0012	0.0018	0.0025	0.0031	0.0037	
			Feed (ipm)	1.5	1.5	1.5	1.5	1.5	1.5	1.5	
	M CAST IRONS Gray, Malleable, Ductile	≤ 220 Bhn or ≤ 19 HRc	350 (280-420)	RPM	10696	7131	5348	3565	2674	2139	1783
				Fr	0.0037	0.0056	0.0075	0.0112	0.0150	0.0187	0.0224
				Feed (ipm)	40.0	40.0	40.0	40.0	40.0	40.0	40.0
≤ 260 Bhn or ≤ 26 HRc		310 (248-372)	RPM	9474	6316	4737	3158	2368	1895	1579	
			Fr	0.0039	0.0059	0.0078	0.0117	0.0156	0.0195	0.0234	
			Feed (ipm)	37.0	37.0	37.0	37.0	37.0	37.0	37.0	
M STAINLESS STEELS (FREE MACHINING) 303, 416, 420F, 430F, 440F		≤ 185 Bhn or ≤ 9 HRc	290 (232-348)	RPM	8862	5908	4431	2954	2216	1772	1477
				Fr	0.0020	0.0030	0.0039	0.0059	0.0079	0.0099	0.0118
				Feed (ipm)	17.5	17.5	17.5	17.5	17.5	17.5	17.5
		≤ 275 Bhn or ≤ 28 HRc	180 (144-216)	RPM	5501	3667	2750	1834	1375	1100	917
				Fr	0.0018	0.0027	0.0036	0.0055	0.0073	0.0091	0.0109
				Feed (ipm)	10.0	10.0	10.0	10.0	10.0	10.0	10.0
	M STAINLESS STEELS (DIFFICULT) 304, 316, 321, 13-8 PH, 15-5PH, 17-4 PH, Custom 450	≤ 275 Bhn or ≤ 28 HRc	130 (104-156)	RPM	3973	2649	1986	1324	993	795	662
				Fr	0.0018	0.0026	0.0035	0.0053	0.0070	0.0088	0.0106
				Feed (ipm)	7.0	7.0	7.0	7.0	7.0	7.0	7.0
		≤ 375 Bhn or ≤ 40 HRc	95 (76-114)	RPM	2903	1935	1452	968	726	581	484
				Fr	0.0016	0.0023	0.0031	0.0047	0.0062	0.0078	0.0093
				Feed (ipm)	4.5	4.5	4.5	4.5	4.5	4.5	4.5

continued on next page

Series	Hardness	Vc (sfm)	Diameter (D ₁) (inch)								
			1/8	3/16	1/4	3/8	1/2	5/8	3/4		
S FRACTIONAL SUPER ALLOYS (NICKEL, COBALT, IRON BASE) Inconel 601, 617, 625, Incoloy, Monel 400, Rene, Waspaloy	≤ 300 Bhn or ≤ 32 HRc	65	RPM	1986	1324	993	662	497	397	331	
		(52-78)	Fr	0.0009	0.0013	0.0017	0.0026	0.0034	0.0043	0.0051	
			Feed (ipm)	1.7	1.7	1.7	1.7	1.7	1.7	1.7	
	≤ 400 Bhn or ≤ 43 HRc	35	RPM	1070	713	535	357	267	214	178	
		(28-42)	Fr	0.0006	0.0008	0.0011	0.0017	0.0022	0.0028	0.0034	
			Feed (ipm)	0.6	0.6	0.6	0.6	0.6	0.6	0.6	
	S TITANIUM ALLOYS Pure Titanium, Ti6Al4V, Ti6Al2Sn4Zr2Mo, Ti4Al4Mo2Sn0.5Si, Ti-6Al4V	≤ 275 Bhn or ≤ 28 HRc	185	RPM	5654	3769	2827	1885	1413	1131	942
			(148-222)	Fr	0.0016	0.0024	0.0032	0.0048	0.0064	0.0080	0.0096
				Feed (ipm)	9.0	9.0	9.0	9.0	9.0	9.0	9.0
		≤ 350 Bhn or ≤ 38 HRc	140	RPM	4278	2852	2139	1426	1070	856	713
			(112-168)	Fr	0.0012	0.0018	0.0023	0.0035	0.0047	0.0058	0.0070
				Feed (ipm)	5.0	5.0	5.0	5.0	5.0	5.0	5.0
≤ 440 Bhn or ≤ 47 HRc		75	RPM	2292	1528	1146	764	573	458	382	
		(60-90)	Fr	0.0010	0.0015	0.0020	0.0030	0.0040	0.0050	0.0060	
			Feed (ipm)	2.3	2.3	2.3	2.3	2.3	2.3	2.3	
N ALUMINUM ALLOYS 2017, 2024, 356, 6061, 7075		≤ 80 Bhn or ≤ 47 HRb	730	RPM	22309	14873	11154	7436	5577	4462	3718
			(584-876)	Fr	0.0045	0.0067	0.0090	0.0134	0.0179	0.0224	0.0269
				Feed (ipm)	100.0	100.0	100.0	100.0	100.0	100.0	100.0
	≤ 150 Bhn or ≤ 7 HRc	635	RPM	19406	12937	9703	6469	4851	3881	3234	
		(508-762)	Fr	0.0046	0.0070	0.0093	0.0139	0.0186	0.0232	0.0278	
			Feed (ipm)	90.0	90.0	90.0	90.0	90.0	90.0	90.0	
	N COPPER ALLOYS Alum Bronze, C110, Muntz Brass	≤ 140 Bhn or ≤ 3 HRc	255	RPM	7793	5195	3896	2598	1948	1559	1299
			(204-306)	Fr	0.0018	0.0027	0.0036	0.0054	0.0072	0.0090	0.0108
				Feed (ipm)	14.0	14.0	14.0	14.0	14.0	14.0	14.0
		≤ 200 Bhn or ≤ 23 HRc	235	RPM	7182	4788	3591	2394	1795	1436	1197
			(188-282)	Fr	0.0018	0.0027	0.0036	0.0054	0.0072	0.0091	0.0109
				Feed (ipm)	13.0	13.0	13.0	13.0	13.0	13.0	13.0

Bhn (Brinell) HRc (Rockwell C) HRb (Rockwell B)

$rpm = Vc \times 3.82 / D_1$

$ipm = Fr \times rpm$

reduce speed and feed for materials harder than listed

refer to the KYOCERA SGS Tool Wizard® for complete technical information (www.kyocera-sgstool.com)

Series 140M 8D Metric	Hardness	Vc (m/min)	Diameter (D1) (mm)								
			3	6	8	10	12	14	16		
P CARBON STEELS 1018, 1040, 1080, 1090, 10L50, 1140, 1212, 12L15, 1525, 1536	≤ 175 Bhn or ≤ 7 HRc	123	RPM	13087	6544	4908	3926	3272	2804	2454	
		(100-170)	Fr	0.085	0.171	0.228	0.285	0.342	0.399	0.455	
			Feed (mm/min)	1118	1118	1118	1118	1118	1118	1118	
	≤ 275 Bhn or ≤ 28 HRc	113	RPM	11956	5978	4484	3587	2989	2562	2242	
		(90-135)	Fr	0.072	0.144	0.193	0.241	0.289	0.337	0.385	
			Feed (mm/min)	864	864	864	864	864	864	864	
	≤ 425 Bhn or ≤ 45 HRc	64	RPM	6786	3393	2545	2036	1696	1454	1272	
		(51-77)	Fr	0.062	0.124	0.165	0.206	0.247	0.288	0.329	
			Feed (mm/min)	419	419	419	419	419	419	419	
	H ALLOY STEELS 4140, 4150, 4320, 5120, 5150, 8630, 86L20, 50100	≤ 275 Bhn or ≤ 28 HRc	98	RPM	10340	5170	3878	3102	2585	2216	1939
			(78-117)	Fr	0.061	0.123	0.164	0.205	0.246	0.287	0.328
				Feed (mm/min)	635	635	635	635	635	635	635
≤ 375 Bhn or ≤ 40 HRc		58	RPM	6140	3070	2302	1842	1535	1316	1151	
		(46-69)	Fr	0.048	0.095	0.127	0.159	0.190	0.222	0.254	
			Feed (mm/min)	292	292	292	292	292	292	292	
≤ 450 Bhn or ≤ 48 HRc		41	RPM	4362	2181	1636	1309	1091	935	818	
		(33-49)	Fr	0.038	0.076	0.101	0.126	0.151	0.177	0.202	
			Feed (mm/min)	165	165	165	165	165	165	165	
K TOOL STEELS A2, D2, H13, L2, M2, P20, S7, T15, W2		≤ 200 Bhn or ≤ 13 HRc	43	RPM	4524	2262	1696	1357	1131	969	848
			(34-51)	Fr	0.048	0.095	0.127	0.159	0.191	0.223	0.255
				Feed (mm/min)	216	216	216	216	216	216	216
	≤ 375 Bhn or ≤ 40 HRc	27	RPM	2908	1454	1091	872	727	623	545	
		(22-33)	Fr	0.026	0.052	0.070	0.087	0.105	0.122	0.140	
			Feed (mm/min)	76	76	76	76	76	76	76	
	≤ 475 Bhn or ≤ 50 HRc	24	RPM	2585	1293	969	776	646	554	485	
		(20-29)	Fr	0.015	0.029	0.039	0.049	0.059	0.069	0.079	
			Feed (mm/min)	38	38	38	38	38	38	38	
	M CAST IRONS Gray, Malleable, Ductile	≤ 220 Bhn or ≤ 19 HRc	107	RPM	11310	5655	4241	3393	2827	2424	2121
			(85-128)	Fr	0.090	0.180	0.240	0.299	0.359	0.419	0.479
				Feed (mm/min)	1016	1016	1016	1016	1016	1016	1016
≤ 260 Bhn or ≤ 26 HRc		94	RPM	10017	5009	3756	3005	2504	2147	1878	
		(76-113)	Fr	0.094	0.188	0.250	0.313	0.375	0.438	0.500	
			Feed (mm/min)	940	940	940	940	940	940	940	
M STAINLESS STEELS (FREE MACHINING) 303, 416, 420F, 430F, 440F	≤ 185 Bhn or ≤ 9 HRc	88	RPM	9371	4686	3514	2811	2343	2008	1757	
		(71-106)	Fr	0.047	0.095	0.126	0.158	0.190	0.221	0.253	
			Feed (mm/min)	445	445	445	445	445	445	445	
	≤ 275 Bhn or ≤ 28 HRc	55	RPM	5816	2908	2181	1745	1454	1246	1091	
		(44-66)	Fr	0.044	0.087	0.116	0.146	0.175	0.204	0.233	
			Feed (mm/min)	254	254	254	254	254	254	254	
	M STAINLESS STEELS (DIFFICULT) 304, 316, 321, 13-8 PH, 15-5PH, 17-4 PH, Custom 450	≤ 275 Bhn or ≤ 28 HRc	40	RPM	4201	2100	1575	1260	1050	900	788
			(32-48)	Fr	0.042	0.085	0.113	0.141	0.169	0.198	0.226
				Feed (mm/min)	178	178	178	178	178	178	178
		≤ 375 Bhn or ≤ 40 HRc	29	RPM	3070	1535	1151	921	767	658	576
			(23-35)	Fr	0.037	0.074	0.099	0.124	0.149	0.174	0.199
				Feed (mm/min)	114	114	114	114	114	114	114

continued on next page

Series 140M 8D Metric	Hardness	Vc (m/min)	Diameter (D ₁) (mm)								
			3	6	8	10	12	14	16		
SUPER ALLOYS (NICKEL, COBALT, IRON BASE) Inconel 601, 617, 625, Incoloy, Monel 400, Rene, Waspaloy	≤ 300 Bhn or ≤ 32 HRc	20	RPM	2100	1050	788	630	525	450	394	
		(16-24)	Fr	0.021	0.041	0.055	0.069	0.082	0.096	0.110	
			Feed (mm/min)	43	43	43	43	43	43	43	
	≤ 400 Bhn or ≤ 43 HRc	11	RPM	1131	565	424	339	283	242	212	
		(9-13)	Fr	0.013	0.027	0.036	0.045	0.054	0.063	0.072	
			Feed (mm/min)	15	15	15	15	15	15	15	
	TITANIUM ALLOYS Pure Titanium, Ti6Al4V, Ti6Al2Sn4Zr2Mo, Ti4Al4Mo2Sn0.5Si, Ti-6Al4V	≤ 275 Bhn or ≤ 28 HRc	56	RPM	5978	2989	2242	1793	1495	1281	1121
			(45-68)	Fr	0.038	0.076	0.102	0.127	0.153	0.178	0.204
				Feed (mm/min)	229	229	229	229	229	229	229
		≤ 350 Bhn or ≤ 38 HRc	43	RPM	4524	2262	1696	1357	1131	969	848
			(34-51)	Fr	0.028	0.056	0.075	0.094	0.112	0.131	0.150
				Feed (mm/min)	127	127	127	127	127	127	127
≤ 440 Bhn or ≤ 47 HRc		23	RPM	2424	1212	909	727	606	519	454	
		(18-27)	Fr	0.024	0.048	0.064	0.080	0.096	0.112	0.129	
			Feed (mm/min)	58	58	58	58	58	58	58	
ALUMINUM ALLOYS 2017, 2024, 356, 6061, 7075		≤ 80 Bhn or ≤ 47 HRb	223	RPM	23589	11795	8846	7077	5897	5055	4423
			(178-267)	Fr	0.108	0.215	0.287	0.359	0.431	0.502	0.574
				Feed (mm/min)	2540	2540	2540	2540	2540	2540	2540
	≤ 150 Bhn or ≤ 7 HRc	194	RPM	20519	10260	7695	6156	5130	4397	3847	
		(155-232)	Fr	0.111	0.223	0.297	0.371	0.446	0.520	0.594	
			Feed (mm/min)	2286	2286	2286	2286	2286	2286	2286	
	COPPER ALLOYS Alum Bronze, C110, Muntz Brass	≤ 140 Bhn or ≤ 3 HRc	78	RPM	8240	4120	3090	2472	2060	1766	1545
			(62-93)	Fr	0.043	0.086	0.115	0.144	0.173	0.201	0.230
				Feed (mm/min)	356	356	356	356	356	356	356
		≤ 200 Bhn or ≤ 23 HRc	72	RPM	7594	3797	2848	2278	1898	1627	1424
			(57-86)	Fr	0.043	0.087	0.116	0.145	0.174	0.203	0.232
				Feed (mm/min)	330	330	330	330	330	330	330

Bhn (Brinell) HRc (Rockwell C) HRb (Rockwell B)

rpm = (Vc x 1000) / (D₁ x 3.14)

mm/min = Fr x rpm

reduce speed and feed for materials harder than listed

refer to the KYOCERA SGS Tool Wizard® for complete technical information (www.kyocera-sgstool.com)

Series 120



3xD



120

FRACTIONAL & METRIC SERIES

- Double margin construction design stabilizes the drill for greater hole accuracy and improved surface finish
- Notched point reduces thrust force over conventional designs
- 8 facet point reduces fiber breakout and delamination on exit

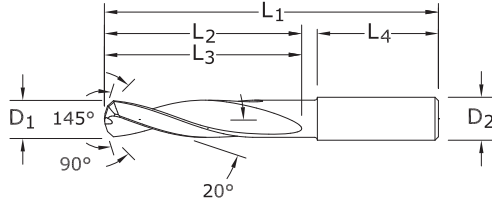

CUTTING DIAMETER D ₁	DECIMAL EQUIV.	METRIC EQUIV.	SHANK DIAMETER D ₂	OVERALL LENGTH L ₁	FLUTE LENGTH L ₂ /L ₃	SHANK LENGTH L ₄	Di-NAMITE® (Diamond) EDP NO.
#40	0.0980	2.49	1/8	2	9/16	1-1/4	50000
2,7 mm	0.1063		6,0	63,0	20,0	32,0	50001
3,0 mm	0.1181		6,0	63,0	20,0	36,0	50002
1/8	0.1250	3.18	1/4	2-1/2	3/4	1-7/16	50003
3,2 mm	0.1260		6,0	63,0	20,0	36,0	50004
#30	0.1285	3.26	1/4	2-1/2	3/4	1-7/16	50005
#28	0.1405	3.57	1/4	2-1/2	3/4	1-7/16	50006
#22	0.1570	3.99	1/4	2-5/8	7/8	1-7/16	50007
#21	0.1590	4.04	1/4	2-5/8	7/8	1-7/16	50008
4,1 mm	0.1614		6,0	66,0	24,0	36,0	50009
#19	0.1660	4.22	1/4	2-5/8	7/8	1-7/16	50010
11/64	0.1719	4.37	1/4	2-5/8	7/8	1-7/16	50011
3/16	0.1875	4.76	1/4	2-5/8	1	1-7/16	50012
#11	0.1910	4.85	1/4	2-5/8	1	1-7/16	50013
#8	0.1990	5.05	1/4	2-5/8	1	1-7/16	50014
#7	0.2010	5.11	1/4	2-5/8	1	1-7/16	50015
#2	0.2210	5.61	1/4	2-5/8	1	1-7/16	50016
6,0 mm	0.2362		6,0	66,0	28,0	36,0	50017
1/4	0.2500	6.35	1/4	3-1/8	1-5/16	1-7/16	50018
.2510	0.2510	6.38	5/16	3-1/8	1-5/16	1-7/16	50019
F	0.2570	6.53	5/16	3-1/8	1-5/16	1-7/16	50020
I	0.2720	6.91	5/16	3-1/8	1-5/16	1-7/16	50021
J	0.2770	7.04	5/16	3-1/8	1-5/16	1-7/16	50022
K	0.2810	7.14	5/16	3-1/8	1-9/16	1-7/16	50023
5/16	0.3125	7.94	5/16	3-1/8	1-9/16	1-7/16	50024
8,0 mm	0.3150		8,0	79,0	41,0	36,0	50025
3/8	0.3750	9.53	3/8	3-1/2	1-27/32	1-9/16	50026
V	0.3770	9.58	1/2	3-1/2	1-27/32	1-9/16	50027
10,0 mm	0.3937		10,0	89,0	47,0	40,0	50028
7/16	0.4375	11.11	1/2	4-1/16	2-3/16	1-9/16	50029
12,0 mm	0.4724		12,0	102,0	55,0	45,0	50030
1/2	0.5000	12.70	1/2	4-1/4	2-5/16	1-3/4	50031

TOLERANCES (inch)

D₁ = +.0000/--.0005
D₂ = h₆

TOLERANCES (mm)

D₁ = +0,000/-0,013
D₂ = h₆

PLASTICS/COMPOSITES

For patent information visit www.ksptpatents.com

Series 120

Series 120 Fractional	Vc (sfm)		Diameter (D ₁) (inch)						
			1/8	3/16	1/4	5/16	3/8	7/16	1/2
N CFRP, AFRP (Carbon Fiber, Aramid Fiber)	320 (256-384)	RPM	9779	6519	4890	3912	3260	2794	2445
		Fr	0.0006	0.0009	0.0012	0.0015	0.0018	0.0021	0.0024
		Feed (ipm)	5.9	5.9	5.9	5.9	5.9	5.9	5.9
N GFRP (Fiberglass)	240 (192-288)	RPM	7334	4890	3667	2934	2445	2096	1834
		Fr	0.0006	0.0009	0.0012	0.0015	0.0018	0.0021	0.0024
		Feed (ipm)	4.4	4.4	4.4	4.4	4.4	4.4	4.4
N CARBON, GRAPHITE	400 (320-480)	RPM	12224	8149	6112	4890	4075	3493	3056
		Fr	0.0008	0.0012	0.0016	0.0020	0.0024	0.0028	0.0032
		Feed (ipm)	9.8	9.8	9.8	9.8	9.8	9.8	9.8

rpm = Vc x 3.82 / D₁

ipm = Fr x rpm

adjust speed and / or feed based on resin type and / or fiber structure

refer to the KYOCERA SGS Tool Wizard® for complete technical information (www.kyocera-sgstool.com)

Series 120 Metric	Vc (m/min)		Diameter (D ₁) (mm)						
			2.5	3	4	6	8	10	12
N CFRP, AFRP (Carbon Fiber, Aramid Fiber)	100 (80-120)	RPM	12722	10602	7951	5301	3976	3181	2650
		Fr	0.012	0.014	0.019	0.028	0.038	0.047	0.057
		Feed (mm/min)	150	150	150	150	150	150	150
N GFRP (Fiberglass)	75 (65-90)	RPM	9542	7951	5963	3976	2982	2385	1988
		Fr	0.012	0.014	0.019	0.029	0.039	0.048	0.058
		Feed (mm/min)	115	115	115	115	115	115	115
N CARBON, GRAPHITE	120 (96-144)	RPM	15266	12722	9542	6361	4771	3817	3181
		Fr	0.015	0.018	0.025	0.037	0.049	0.062	0.074
		Feed (mm/min)	235	235	235	235	235	235	235

rpm = (Vc x 1000) / (D₁ x 3.14)

mm/min = Fr x rpm

adjust speed and / or feed based on resin type and / or fiber structure

refer to the KYOCERA SGS Tool Wizard® for complete technical information (www.kyocera-sgstool.com)



General Purpose Drills



Hole Making

GENERAL PURPOSE DRILLS	SERIES	DESCRIPTION	PAGE
2 Flute	101	2 Flute Slow Spiral	302
Short Length Self Centering (DIN6539)	108M Plus	2 Flute Short Length DIN 6539	307
Straight Flute	106	Straight Flute 140 Point Geometry	314
3 Flute with 150 Point Geometry	103	3 Flute 150 Point Geometry	318

GENERAL PURPOSE COUNTERSINKS	SERIES	DESCRIPTION	PAGE
Combined Drill & Countersink	301	2 Flute Straight Flute Combined Drill and Countersink Fractional	324
	301M	2 Flute Straight Flute Combined Drill and Countersink Metric	325
Single Flute Countersink	601	Single Flute Fractional	330
3 Flute Countersink	603	3 Flute Fractional	333
6 Flute Countersink	606	6 Flute Fractional	336

GENERAL PURPOSE REAMERS	SERIES	DESCRIPTION	PAGE
Straight Flute Accu-Reamer	200	Accu-Reamer	340
Straight Flute Reamer	201M	Metric Reamer	344

Speed & Feed Recommendations listed after each series

Taladrado

TALADROS DE USO GENERAL	SERIE	DESCRIPCIÓN	PÁGINA
2 filos	101	2 filos, espiral de avance lento	302
Autocentrante de longitud corta (DIN6539)	108M Plus	2 filos, longitud corta, DIN 6539	307
Filo recto	106	Filo recto, geometría de 140 puntos	314
3 filos con geometría de 150 puntos	103	3 filos, geometría de 150 puntos	318

TALADROS DE USO AVELLANADORES	SERIE	DESCRIPCIÓN	PÁGINA
Taladro y avellanador combinados	301	2 filos, filo recto, taladro y avellanador combinados, fraccional	324
	301M	2 filos, filo recto, taladro y avellanador combinados, métrico	325
Avellanador de filo único	601	Filo único, fraccional	330
Avellanador de 3 filos	603	3 filos, fraccional	333
Avellanador de 6 filos	606	6 filos, fraccional	336

TALADROS DE USO ESCARIADORES	SERIE	DESCRIPCIÓN	PÁGINA
Escariador Accu de filo recto	200	Escariador Accu	340
Escariador de filo recto	201M	Escariador métrico	344

Recomendaciones de velocidades y avances mostradas tras cada serie

Outils de perçage

FORETS UNIVERSELS	SERIES	DESCRIPTION	PAGE
2 dents	101	2 dents à spirale lente	302
Court autocentrant (DIN 6539)	108M Plus	2 dents court DIN 6539	307
Denture droite	106	Denture droite à angle de pointe 140°	314
3 dents à angle de pointe 150°	103	3 dents à angle de pointe 150°	318

FORETS À FRAISER	SERIES	DESCRIPTION	PAGE
Foret et foret à fraiser combinés	301	2 dents denture droite foret et foret à fraiser combinés (fractionnel)	324
	301M	2 dents denture droite foret et foret à fraiser combinés (métrique)	325
Foret à fraiser à dent simple	601	Foret à dent simple (fractionnel)	330
Foret à fraiser 3 dents	603	3 dents (fractionnel)	333
foret à fraiser 6 dents	606	6 dents (fractionnel)	336

FORETS À ALÉSOIRS	SERIES	DESCRIPTION	PAGE
Alésoir denture droite Accu-Reamer	200	Alésoir Accu-Reamer	340
Alésoir denture droite	201M	Alésoir (métrique)	344

Recommandations de vitesse et avance indiquées après chaque série

ALLZWECK-BOHRER	SERIE	BESCHREIBUNG	SEITE
2 Schneidekanten	101	2 Schneidekanten mit kleinem Spanwinkel	302
Kurze Bauform Selbstzentrierung (DIN 6539)	108M Plus	2 Schneidekanten Kurze Bauform DIN 6539	307
Gerade Schneidekante	106	Gerade Schneidekante Spitzengeometrie 140	314
3 Schneidekanten mit Spitzengeometrie 150	103	3 Schneidekanten Spitzengeometrie 150	318

ALLZWECK-BOHRER	SERIE	BESCHREIBUNG	SEITE
Senkbohrer	301	Zölliger Senkbohrer mit 2 geraden Schneidekanten	324
	301M	Metrischer Senkbohrer mit 2 geraden Schneidekanten	325
Senker mit 1 Schneidekante	601	Zölliger Bohrer mit 1 Schneidekante	330
Senkbohrer mit 1 Schneidekante	603	Zölliger Bohrer mit 3 Schneidekanten	333
Senkbohrer mit 6 Schneidekanten	606	Zölliger Bohrer mit 6 Schneidekanten	336

ALLZWECK-BOHRER	SERIE	BESCHREIBUNG	SEITE
Reibahlen mit gerader Schneidekante	200	Accu-Reamer	340
Reibahle mit gerader Schneidekante	201M	Metrische Reibahle	344

Empfehlungen für Drehzahl & Vorschub im Anhang zu jeder Serie

2 Flute Drills • Metric: DIN 338



5xD



2

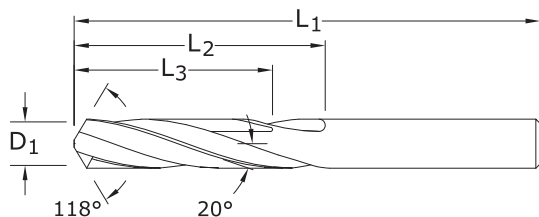

101

FRACTIONAL & METRIC SERIES



Pictured:
Series 101 Drill Set

CUTTING DIAMETER D ₁	DECIMAL EQUIV.	METRIC EQUIV.	OVERALL LENGTH L ₁	FLUTE LENGTH L ₂	CLEARED LENGTH L ₃	EDP NO.	
						UNCOATED	Ti-NAMITE-A (AlTiN)
#80	0.0135	0.34	3/4	3/16	—	51080	57076
#79	0.0145	0.37	3/4	3/16	—	51079	57077
1/64	0.0156	0.40	3/4	3/16	—	51101	57078
#78	0.0160	0.41	3/4	3/16	—	51078	57079
#77	0.0180	0.46	3/4	3/16	—	51077	57080
#76	0.0200	0.51	7/8	1/4	—	51076	57081
#75	0.0210	0.53	7/8	1/4	—	51075	57082
#74	0.0225	0.57	7/8	1/4	—	51074	57083
#73	0.0240	0.61	7/8	1/4	—	51073	57084
#72	0.0250	0.64	1	5/16	—	51072	57085
#71	0.0260	0.66	1	5/16	—	51071	57086
0,7 mm	0.0276		28,0	9,0	—	61001	68268
#70	0.0280	0.71	1-1/4	1/2	—	51070	57087
#69	0.0292	0.74	1-1/4	1/2	—	51069	57088
#68	0.0310	0.79	1-1/4	1/2	—	51068	57089
1/32	0.0312	0.79	1-1/4	1/2	—	51102	57090
0,8 mm	0.0315		30,0	10,0	—	61003	68269
#67	0.0320	0.81	1-1/4	1/2	—	51067	57091
#66	0.0330	0.84	1-1/4	1/2	—	51066	57092
#65	0.0350	0.89	1-3/8	5/8	1/2	51065	57093
0,9 mm	0.0354		32,0	11,0	8,0	61005	68270
#64	0.0360	0.91	1-3/8	5/8	1/2	51064	57094
#63	0.0370	0.94	1-3/8	5/8	1/2	51063	57095
#62	0.0380	0.97	1-3/8	5/8	1/2	51062	57096
#61	0.0390	0.99	1-3/8	5/8	1/2	51061	57097
1,0 mm	0.0394		34,0	12,0	9,0	61007	68271
#60	0.0400	1.02	1-1/2	3/4	39/64	51060	57098
#59	0.0410	1.04	1-1/2	3/4	39/64	51059	57099
#58	0.0420	1.07	1-1/2	3/4	39/64	51058	57100
#57	0.0430	1.09	1-1/2	3/4	39/64	51057	57101
1,1 mm	0.0433		36,0	14,0	11,0	61052	68294
#56	0.0465	1.18	1-1/2	3/4	39/64	51056	57102
3/64	0.0469	1.19	1-1/2	3/4	39/64	51103	57103
1,2 mm	0.0472		38,0	16,0	12,0	61053	68295
1,3 mm	0.0512		38,0	16,0	12,0	61054	68296
#55	0.0520	1.32	1-1/2	3/4	39/64	51055	57104
#54	0.0550	1.40	1-1/2	3/4	39/64	51054	57105
1,4 mm	0.0551		40,0	18,0	14,0	61055	68297
1,5 mm	0.0591		40,0	18,0	14,0	61009	68272
#53	0.0595	1.51	1-1/2	3/4	39/64	51053	57106
*1/16	0.0625	1.59	1-1/2	3/4	39/64	51104	57107
1,6 mm	0.0630		43,0	20,0	16,0	61056	68298
#52	0.0635	1.61	1-1/2	3/4	39/64	51052	57108
1,7 mm	0.0669		43,0	20,0	17,0	61057	68299
#51	0.0670	1.70	1-1/2	3/4	39/64	51051	57109

TOLERANCES (inch)

D₁ = +.0000/-.0005

TOLERANCES (mm)

D₁ = +0,0000/-0,0127

- STEELS
- STAINLESS STEELS
- CAST IRON
- HIGH TEMP ALLOYS
- TITANIUM
- HARDENED STEELS
- NON-FERROUS
- PLASTICS/COMPOSITES

For patent information visit www.ksptpatents.com

continued on next page

2 Flute Drills • Metric: DIN 338

101

FRACTIONAL & METRIC SERIES

CONTINUED

CUTTING DIAMETER D ₁	DECIMAL EQUIV.	METRIC EQUIV.	OVERALL LENGTH L ₁	FLUTE LENGTH L ₂	CLEARED LENGTH L ₃	EDP NO.	
						UNCOATED	Ti-NAMITE-A (AITIN)
#50	0.0700	1.78	1-3/4	7/8	45/64	51050	57110
1,8 mm	0.0709		46,0	22,0	17,0	61058	68300
#49	0.0730	1.85	1-3/4	7/8	45/64	51049	57111
1,9 mm	0.0748		46,0	22,0	17,0	61059	68301
#48	0.0760	1.93	1-3/4	7/8	45/64	51048	57112
5/64	0.0781	1.98	1-3/4	7/8	45/64	51105	57113
#47	0.0785	1.99	1-3/4	7/8	45/64	51047	57114
2,0 mm	0.0787		49,0	24,0	19,0	61011	68273
#46	0.0810	2.06	1-3/4	7/8	45/64	51046	57115
#45	0.0820	2.08	1-3/4	7/8	45/64	51045	57116
2,1 mm	0.0827		49,0	24,0	19,0	61060	68302
#44	0.0860	2.18	2	1	51/64	51044	57117
2,2 mm	0.0866		53,0	27,0	21,0	61061	68303
#43	0.0890	2.26	2	1	51/64	51043	57118
2,3 mm	0.0906		53,0	27,0	21,0	61062	68304
#42	0.0935	2.37	2	1	51/64	51042	57119
3/32	0.0938	2.38	2	1	51/64	51106	57120
2,4 mm	0.0945		57,0	30,0	24,0	61063	68305
#41	0.0960	2.44	2	1	51/64	51041	57121
#40	0.0980	2.49	2	1	51/64	51040	57122
2,5 mm	0.0984		57,0	30,0	24,0	61013	68274
#39	0.0995	2.53	2-1/4	1-1/4	1	51039	57123
#38	0.1015	2.58	2-1/4	1-1/4	1	51038	57124
2,6 mm	0.1024		57,0	30,0	24,0	61064	68306
#37	0.1040	2.64	2-1/4	1-1/4	1	51037	57125
2,7 mm	0.1063		61,0	33,0	26,0	61065	68307
#36	0.1065	2.71	2-1/4	1-1/4	1	51036	57126
7/64	0.1094	2.78	2-1/4	1-1/4	1	51107	57127
#35	0.1100	2.79	2-1/4	1-1/4	1	51035	57128
2,8 mm	0.1102		61,0	33,0	26,0	61066	68308
#34	0.1110	2.82	2-1/4	1-1/4	1	51034	57129
#33	0.1130	2.87	2-1/4	1-1/4	1	51033	57130
2,9 mm	0.1142		61,0	33,0	26,0	61067	68309
#32	0.1160	2.95	2-1/4	1-1/4	1	51032	57131
3,0 mm	0.1181		61,0	33,0	26,0	61015	68275
#31	0.1200	3.05	2-1/4	1-1/4	1	51031	57132
3,1 mm	0.1220		65,0	36,0	28,0	61068	68310
*1/8	0.1250	3.18	2-1/4	1-1/4	1	51108	57133
3,2 mm	0.1260		65,0	36,0	28,0	61069	68311
#30	0.1285	3.26	2-1/4	1-1/4	1	51030	57134
3,3 mm	0.1299		65,0	36,0	28,0	61070	68312
3,4 mm	0.1339		70,0	39,0	31,0	61071	68313
#29	0.1360	3.45	2-1/2	1-3/8	1-7/64	51029	57135
3,5 mm	0.1378		70,0	39,0	31,0	61017	68276
#28	0.1405	3.57	2-1/2	1-3/8	1-7/64	51028	57136
9/64	0.1406	3.57	2-1/2	1-3/8	1-7/64	51109	57137
3,6 mm	0.1417		70,0	39,0	31,0	61072	68314
#27	0.1440	3.66	2-1/2	1-3/8	1-7/64	51027	57138
3,7 mm	0.1457		70,0	39,0	31,0	61073	68315
#26	0.1470	3.73	2-1/2	1-3/8	1-7/64	51026	57139
#25	0.1495	3.80	2-1/2	1-3/8	1-7/64	51025	57140
3,8 mm	0.1496		75,0	43,0	34,0	61074	68316
#24	0.1520	3.86	2-1/2	1-3/8	1-7/64	51024	57141
3,9 mm	0.1535		75,0	43,0	34,0	61075	68317

continued on next page

2 Flute Drills • Metric: DIN 338



5xD



Pictured:
Series 101 Drill Set

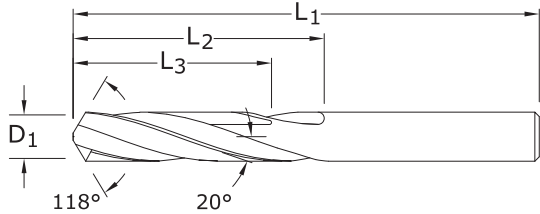

101

FRACTIONAL & METRIC SERIES

CUTTING DIAMETER D ₁	DECIMAL EQUIV.	METRIC EQUIV.	OVERALL LENGTH L ₁	FLUTE LENGTH L ₂	CLEARED LENGTH L ₃	EDP NO.	
						UNCOATED	Ti-NAMITE-A (AlTiN)
#23	0.1540	3.91	2-1/2	1-3/8	1-7/64	51023	57142
5/32	0.1562	3.97	2-1/2	1-3/8	1-7/64	51110	57143
#22	0.1570	3.99	2-1/2	1-3/8	1-7/64	51022	57144
4,0 mm	0.1575		75,0	43,0	34,0	61019	68277
#21	0.1590	4.04	2-1/2	1-3/8	1-7/64	51021	57145
#20	0.1610	4.09	2-1/2	1-3/8	1-7/64	51020	57146
4,1 mm	0.1614		75,0	43,0	34,0	61076	68318
4,2 mm	0.1654		75,0	43,0	34,0	61077	68319
#19	0.1660	4.22	2-1/2	1-5/8	1-19/64	51019	57147
4,3 mm	0.1693		80,0	47,0	37,0	61078	68320
#18	0.1695	4.31	2-3/4	1-5/8	1-19/64	51018	57148
11/64	0.1719	4.37	2-3/4	1-5/8	1-19/64	51111	57149
#17	0.1730	4.39	2-3/4	1-5/8	1-19/64	51017	57150
4,4 mm	0.1732		80,0	47,0	37,0	61079	68321
#16	0.1770	4.50	2-3/4	1-5/8	1-19/64	51016	57151
4,5 mm	0.1772		80,0	47,0	37,0	61021	68278
#15	0.1800	4.57	2-3/4	1-5/8	1-19/64	51015	57152
4,6 mm	0.1811		80,0	47,0	37,0	61080	68322
#14	0.1820	4.62	2-3/4	1-5/8	1-19/64	51014	57153
4,7 mm	0.1850		80,0	47,0	37,0	61081	68323
#13	0.1850	4.70	2-3/4	1-5/8	1-19/64	51013	57154
*3/16	0.1875	4.76	2-3/4	1-5/8	1-19/64	51112	57155
4,8 mm	0.1890		86,0	52,0	41,0	61082	68324
#12	0.1890	4.80	2-3/4	1-5/8	1-19/64	51012	57156
#11	0.1910	4.85	2-3/4	1-5/8	1-19/64	51011	57157
4,9 mm	0.1929		86,0	52,0	41,0	61083	68325
#10	0.1935	4.91	2-3/4	1-5/8	1-19/64	51010	57158
#9	0.1960	4.98	3	1-3/4	1-13/32	51009	57159
5,0 mm	0.1969		86,0	52,0	41,0	61023	68279
#8	0.1990	5.05	3	1-3/4	1-13/32	51008	57160
5,1 mm	0.2008		86,0	52,0	41,0	61084	68326
#7	0.2010	5.11	3	1-3/4	1-13/32	51007	57161
13/64	0.2031	5.16	3	1-3/4	1-13/32	51113	57162
#6	0.2040	5.18	3	1-3/4	1-13/32	51006	57163
5,2 mm	0.2047		86,0	52,0	41,0	61085	68327
#5	0.2055	5.22	3	1-3/4	1-13/32	51005	57164
5,3 mm	0.2087		86,0	52,0	41,0	61086	68328
#4	0.2090	5.31	3	1-3/4	1-13/32	51004	57165
5,4 mm	0.2126		93,0	57,0	45,0	61087	68329
#3	0.2130	5.41	3	1-3/4	1-13/32	51003	57166
5,5 mm	0.2165		93,0	57,0	45,0	61025	68280
7/32	0.2188	5.56	3	1-3/4	1-13/32	51114	57167
5,6 mm	0.2205		93,0	57,0	45,0	61088	68330
#2	0.2210	5.61	3	1-3/4	1-13/32	51002	57168

continued on next page

TOLERANCES (inch)

D₁ = +.0000/- .0005

TOLERANCES (mm)

D₁ = +0,0000/-0,0127

- STEELS
- STAINLESS STEELS
- CAST IRON
- HIGH TEMP ALLOYS
- TITANIUM
- HARDENED STEELS
- NON-FERROUS
- PLASTICS/COMPOSITES

For patent information visit www.ksptpatents.com

2 Flute Drills • Metric: DIN 338

101

FRACTIONAL & METRIC SERIES

CONTINUED

CUTTING DIAMETER D ₁	DECIMAL EQUIV.	METRIC EQUIV.	OVERALL LENGTH L ₁	FLUTE LENGTH L ₂	CLEARED LENGTH L ₃	EDP NO.	
						UNCOATED	Ti-NAMITE-A (AITIN)
5,7 mm	0.2244		93,0	57,0	45,0	61089	68331
#1	0.2280	5.79	3	1-3/4	1-13/32	51001	57169
5,8 mm	0.2283		93,0	57,0	45,0	61090	68332
5,9 mm	0.2323		93,0	57,0	45,0	61091	68333
A	0.2340	5.94	3-1/4	2	1-39/64	51201	57170
15/64	0.2344	5.95	3-1/4	2	1-39/64	51115	57171
6,0 mm	0.2362		93,0	57,0	45,0	61027	68281
B	0.2380	6.05	3-1/4	2	1-39/64	51202	57172
6,1 mm	0.2402		101,0	63,0	50,0	61092	68334
C	0.2420	6.15	3-1/4	2	1-39/64	51203	57173
6,2 mm	0.2441		101,0	63,0	50,0	61093	68335
D	0.2460	6.25	3-1/4	2	1-39/64	51204	57174
6,3 mm	0.2480		101,0	63,0	50,0	61094	68336
*1/4	0.2500	6.35	3-1/4	2	1-39/64	51116	57176
6,4 mm	0.2520		101,0	63,0	50,0	61095	68337
6,5 mm	0.2559		101,0	63,0	50,0	61029	68282
F	0.2570	6.53	3-1/4	2	1-39/64	51206	57177
6,6 mm	0.2598		101,0	63,0	50,0	61096	68338
G	0.2610	6.63	3-1/2	2-1/8	1-45/64	51207	57178
6,7 mm	0.2638		101,0	63,0	50,0	61097	68339
17/64	0.2656	6.75	3-1/2	2-1/8	1-45/64	51117	57179
H	0.2660	6.76	3-1/2	2-1/8	1-45/64	51208	57180
6,8 mm	0.2677		109,0	69,0	55,0	61098	68340
6,9 mm	0.2717		109,0	69,0	55,0	61099	68341
I	0.2720	6.91	3-1/2	2-1/8	1-45/64	51209	57181
7,0 mm	0.2756		109,0	69,0	55,0	61031	68283
J	0.2770	7.04	3-1/2	2-1/8	1-45/64	51210	57182
7,1 mm	0.2795		109,0	69,0	55,0	61100	68342
K	0.2810	7.14	3-1/2	2-1/8	1-45/64	51211	57183
9/32	0.2812	7.14	3-1/2	2-1/8	1-45/64	51118	57184
7,2 mm	0.2835		109,0	69,0	55,0	61101	68343
7,3 mm	0.2874		109,0	69,0	55,0	61102	68344
L	0.2900	7.37	3-1/2	2-1/8	1-45/64	51212	57185
7,4 mm	0.2913		109,0	69,0	55,0	61103	68345
M	0.2950	7.49	3-3/4	2-3/8	1-29/32	51213	57186
7,5 mm	0.2953		109,0	69,0	55,0	61033	68284
19/64	0.2969	7.54	3-3/4	2-3/8	1-29/32	51119	57187
7,6 mm	0.2992		117,0	75,0	60,0	61104	68346
N	0.3020	7.67	3-3/4	2-3/8	1-29/32	51214	57188
7,7 mm	0.3031		117,0	75,0	60,0	61105	68347
7,8 mm	0.3071		117,0	75,0	60,0	61106	68348
7,9 mm	0.3110		117,0	75,0	60,0	61107	68349
*5/16	0.3125	7.94	3-3/4	2-3/8	1-29/32	51120	57189
8,0 mm	0.3150		117,0	75,0	60,0	61035	68285
O	0.3160	8.03	3-3/4	2-3/8	1-29/32	51215	57190
8,1 mm	0.3189		117,0	75,0	60,0	61108	68350
8,2 mm	0.3228		117,0	75,0	60,0	61109	68351
P	0.3230	8.20	3-3/4	2-3/8	1-29/32	51216	57191
8,3 mm	0.3268		117,0	75,0	60,0	61110	68352
21/64	0.3281	8.33	4	2-1/2	2	51121	57192
8,4 mm	0.3307		117,0	75,0	60,0	61111	68353
Q	0.3320	8.43	4	2-1/2	2	51217	57193
8,5 mm	0.3346		117,0	75,0	60,0	61037	68286
8,6 mm	0.3386		125,0	81,0	64,0	61112	68354

continued on next page

2 Flute Drills • Metric: DIN 338



5xD

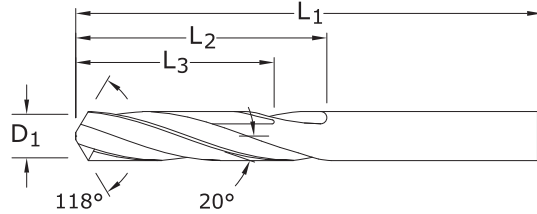

Pictured:
Series 101 Drill Set

101

FRACTIONAL & METRIC SERIES

CUTTING DIAMETER D ₁	DECIMAL EQUIV.	METRIC EQUIV.	OVERALL LENGTH L ₁	FLUTE LENGTH L ₂	CLEARED LENGTH L ₃	EDP NO.	
						UNCOATED	Ti-NAMITE-A (AlTiN)
R	0.3390	8.61	4	2-1/2	2	51218	57194
8,7 mm	0.3425		125,0	81,0	64,0	61113	68355
11/32	0.3438	8.73	4	2-1/2	2	51122	57195
8,8 mm	0.3465		125,0	81,0	64,0	61114	68356
S	0.3480	8.84	4	2-1/2	2	51219	57196
8,9 mm	0.3504		125,0	81,0	64,0	61115	68357
9,0 mm	0.3543		125,0	81,0	64,0	61039	68287
T	0.3580	9.09	4-1/4	2-3/4	2-13/64	51220	57197
9,1 mm	0.3583		125,0	81,0	64,0	61116	68358
23/64	0.3594	9.13	4-1/4	2-3/4	2-13/64	51123	57198
9,2 mm	0.3622		125,0	81,0	64,0	61117	68359
9,3 mm	0.3661		125,0	81,0	64,0	61118	68360
U	0.3680	9.35	4-1/4	2-3/4	2-13/64	51221	57199
9,4 mm	0.3701		125,0	81,0	64,0	61119	68361
9,5 mm	0.3740		125,0	81,0	64,0	61041	68288
*3/8	0.3750	9.53	4-1/4	2-3/4	2-13/64	51124	57200
V	0.3770	9.58	4-1/4	2-3/4	2-13/64	51222	57201
9,6 mm	0.3780		133,0	87,0	69,0	61120	68362
9,7 mm	0.3819		133,0	87,0	69,0	61121	68363
9,8 mm	0.3858		133,0	87,0	69,0	61122	68364
W	0.3860	9.80	4-1/2	2-7/8	2-19/64	51223	57202
9,9 mm	0.3898		133,0	87,0	69,0	61123	68365
25/64	0.3906	9.92	4-1/2	2-7/8	2-19/64	51125	57203
10,0 mm	0.3937		133,0	87,0	69,0	61043	68289
X	0.3970	10.08	4-1/2	2-7/8	2-19/64	51224	57204
10,2 mm	0.4016		133,0	87,0	69,0	61124	68366
Y	0.4040	10.26	4-1/2	2-7/8	2-19/64	51225	57205
13/32	0.4062	10.32	4-1/2	2-7/8	2-19/64	51126	57206
Z	0.4130	10.49	4-1/2	2-7/8	2-19/64	51226	57207
10,5 mm	0.4134		133,0	87,0	69,0	61045	68290
27/64	0.4219	10.72	4-1/2	2-7/8	2-19/64	51127	57208
11,0 mm	0.4331		142,0	94,0	75,0	61047	68291
7/16	0.4375	11.11	4-1/2	2-7/8	2-19/64	51128	57209
11,5 mm	0.4528		142,0	94,0	75,0	61049	68292
29/64	0.4531	11.51	4-3/4	3	2-13/32	51129	57210
15/32	0.4688	11.91	4-3/4	3	2-13/32	51130	57211
12,0 mm	0.4724		151,0	101,0	80,0	61051	68293
31/64	0.4844	12.30	4-3/4	3	2-13/32	51131	57212
1/2	0.5000	12.70	4-3/4	3	2-13/32	51132	57213
*Series 101 Set						61175	57351

TOLERANCES (inch)

D₁ = +.0000/- .0005

TOLERANCES (mm)

D₁ = +0,0000/-0,0127

- STEELS
- STAINLESS STEELS
- CAST IRON
- HIGH TEMP ALLOYS
- TITANIUM
- HARDENED STEELS
- NON-FERROUS
- PLASTICS/COMPOSITES

For patent information visit www.ksptpatents.com

Short Length Self Centering Drills • DIN 6539



3xD

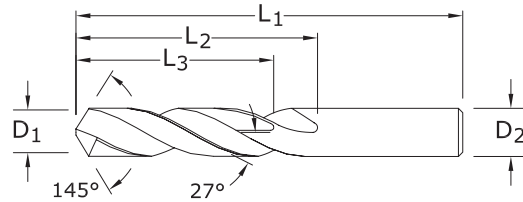

108M Plus METRIC SERIES

TOLERANCES (mm)

≤3 DIAMETER

D₁ = +0,000/-0,010

D₂ = h₆

>3-6 DIAMETER

D₁ = +0,000/-0,012

D₂ = h₆

>6-10 DIAMETER

D₁ = +0,000/-0,015

D₂ = h₆

>10-18 DIAMETER

D₁ = +0,000/-0,018

D₂ = h₆

STEELS

STAINLESS STEELS

CAST IRON

HIGH TEMP ALLOYS

TITANIUM

HARDENED STEELS

NON-FERROUS

PLASTICS/COMPOSITES

For patent information visit www.ksptpatents.com

mm				EDP NO.	
CUTTING DIAMETER D ₁ /D ₂	OVERALL LENGTH L ₁	FLUTE LENGTH L ₂	CLEARED LENGTH L ₃	UNCOATED	Ti-NAMITE-A (AlTiN)
0,5	20,0	3,0	—	62001	68643
0,55	21,0	3,5	—	62003	68644
0,6	21,0	3,5	—	62005	68645
0,65	22,0	4,0	—	62007	68646
0,7	23,0	4,5	—	62009	68647
0,75	23,0	4,5	—	62011	68648
0,8	24,0	5,0	—	62013	68649
0,85	24,0	5,0	—	62015	68650
0,9	25,0	5,5	4,0	62017	68651
0,95	25,0	5,5	4,0	62019	68652
1,0	26,0	6,0	4,7	62021	68653
1,05	26,0	6,0	4,7	62023	68654
1,1	28,0	7,0	5,4	62025	68655
1,15	28,0	7,0	5,4	62027	68656
1,2	30,0	8,0	6,0	62029	68657
1,25	30,0	8,0	6,0	62031	68658
1,3	30,0	8,0	6,0	62033	68659
1,35	32,0	9,0	7,0	62035	68660
1,4	32,0	9,0	7,0	62037	68661
1,45	32,0	9,0	7,0	62039	68662
1,5	32,0	9,0	7,0	62041	68663
1,6	34,0	10,0	7,0	62043	68664
1,7	34,0	10,0	7,0	62045	68665
1,8	36,0	11,0	8,0	62047	68666
1,9	36,0	11,0	8,0	62049	68667
2,0	38,0	12,0	9,0	62051	68668
2,1	38,0	12,0	9,0	62053	68669
2,2	40,0	13,0	10,0	62055	68670
2,3	40,0	13,0	10,0	62057	68671
2,4	43,0	14,0	11,0	62059	68672
2,5	43,0	14,0	11,0	62061	68673
2,6	43,0	14,0	11,0	62063	68674
2,7	46,0	16,0	12,0	62065	68675
2,8	46,0	16,0	12,0	62067	68676

continued on next page

Short Length Self Centering Drills • DIN 6539



3xD

**108M Plus**

METRIC SERIES

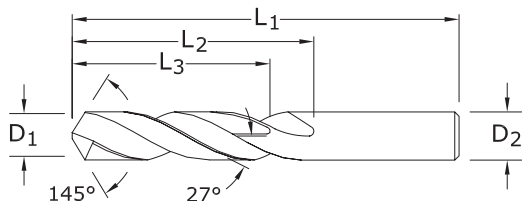

CUTTING DIAMETER D ₁ /D ₂	mm			EDP NO.	
	OVERALL LENGTH L ₁	FLUTE LENGTH L ₂	CLEARED LENGTH L ₃	UNCOATED	Ti-NAMITE-A (AITiN)
2,9	46,0	16,0	12,0	62069	68677
3,0	46,0	16,0	12,0	62071	68678
3,1	49,0	18,0	14,0	62073	68679
3,2	49,0	18,0	14,0	62075	68680
3,3	49,0	18,0	14,0	62077	68681
3,4	52,0	20,0	15,0	62079	68682
3,5	52,0	20,0	15,0	62081	68683
3,6	52,0	20,0	15,0	62083	68684
3,7	52,0	20,0	15,0	62085	68685
3,8	55,0	22,0	17,0	62087	68686
3,9	55,0	22,0	17,0	62089	68687
4,0	55,0	22,0	17,0	62091	68688
4,1	55,0	22,0	17,0	62093	68689
4,2	55,0	22,0	17,0	62095	68690
4,3	58,0	24,0	18,0	62097	68691
4,4	58,0	24,0	18,0	62099	68692
4,5	58,0	24,0	18,0	62101	68693
4,6	58,0	24,0	18,0	62103	68694
4,7	58,0	24,0	18,0	62105	68695
4,8	62,0	26,0	20,0	62107	68696
4,9	62,0	26,0	20,0	62109	68697
5,0	62,0	26,0	20,0	62111	68698
5,1	62,0	26,0	20,0	62113	68699
5,2	62,0	26,0	20,0	62115	68700
5,3	62,0	26,0	20,0	62117	68701
5,4	66,0	28,0	21,0	62119	68702
5,5	66,0	28,0	21,0	62121	68703
5,6	66,0	28,0	21,0	62123	68704
5,7	66,0	28,0	21,0	62125	68705
5,8	66,0	28,0	21,0	62127	68706
5,9	66,0	28,0	21,0	62129	68707
6,0	66,0	28,0	21,0	62131	68708

continued on next page

TOLERANCES (mm)

≤3 DIAMETER

D₁ = +0,000/−0,010D₂ = h₆

>3–6 DIAMETER

D₁ = +0,000/−0,012D₂ = h₆

>6–10 DIAMETER

D₁ = +0,000/−0,015D₂ = h₆

>10–16 DIAMETER

D₁ = +0,000/−0,018D₂ = h₆

STEELS
STAINLESS STEELS
CAST IRON
HIGH TEMP ALLOYS
TITANIUM
HARDENED STEELS
NON-FERROUS
PLASTICS/COMPOSITES

For patent
information visit
www.ksptpatents.com

Short Length Self Centering Drills • DIN 6539

108M Plus

METRIC SERIES

CUTTING DIAMETER D ₁ /D ₂	mm			EDP NO.	
	OVERALL LENGTH L ₁	FLUTE LENGTH L ₂	CLEARED LENGTH L ₃	UNCOATED	Ti-NAMITE-A (AlTiN)
6,1	70,0	31,0	23,0	62133	68709
6,2	70,0	31,0	23,0	62135	68710
6,3	70,0	31,0	23,0	62137	68711
6,4	70,0	31,0	23,0	62139	68712
6,5	70,0	31,0	23,0	62141	68713
6,8	70,0	31,0	23,0	62142	68603
7,0	74,0	34,0	25,0	62143	68718
7,5	74,0	34,0	25,0	62145	68723
7,8	79,0	37,0	27,0	62146	68604
8,0	79,0	37,0	27,0	62147	68728
8,5	79,0	37,0	27,0	62149	68733
9,0	84,0	40,0	29,0	62151	68738
9,5	84,0	40,0	29,0	62153	68743
9,8	89,0	43,0	31,0	62154	68606
10,0	89,0	43,0	31,0	62155	68748
10,2	89,0	43,0	31,0	62156	68607
10,5	89,0	43,0	31,0	62066	68753
11,0	95,0	47,0	33,0	62157	68758
11,5	95,0	47,0	33,0	62084	68763
11,8	102,0	51,0	35,0	62158	68608
12,0	102,0	51,0	35,0	62159	68768
12,5	102,0	51,0	35,0	62102	68773
13,0	102,0	51,0	35,0	62112	68778
13,8	107,0	54,0	37,0	62164	68609
14,0	107,0	54,0	37,0	62116	68780
14,5	111,0	56,0	38,0	62166	68611
14,8	111,0	56,0	38,0	62167	68612
15,0	111,0	56,0	38,0	62168	68613
15,8	115,0	58,0	38,0	62170	68614
16,0	115,0	58,0	38,0	62171	68616

CONTINUED

2 Flute Drills

Series 101 Fractional	Hardness	Vc (sfm)	Diameter (D ₁) (inch)								
			1/64	1/32	1/16	1/8	1/4	3/8	1/2		
P CARBON STEELS 1018, 1040, 1080, 1090, 10L50, 1140, 1212, 12L15, 1525, 1536	≤ 175 Bhn or ≤ 7 HRc	265 (212-318)	RPM	64787	32394	16197	8098	4049	2699	2025	
			Fr	0.00021	0.0004	0.0008	0.0017	0.0033	0.0050	0.0067	
			Feed (ipm)	13.5	13.5	13.5	13.5	13.5	13.5	13.5	
	≤ 300 Bhn or ≤ 32 HRc	125 (100-150)	RPM	30560	15280	7640	3820	1910	1273	955	
			Fr	0.00020	0.0004	0.0008	0.0016	0.0031	0.0047	0.0063	
			Feed (ipm)	6.0	6.0	6.0	6.0	6.0	6.0	6.0	
	≤ 425 Bhn or ≤ 45 HRc	85 (68-102)	RPM	20781	10390	5195	2598	1299	866	649	
			Fr	0.00011	0.0002	0.0004	0.0008	0.0017	0.0025	0.0034	
			Feed (ipm)	2.2	2.2	2.2	2.2	2.2	2.2	2.2	
	H ALLOY STEELS 4140, 4150, 4320, 5120, 5150, 8630, 86L20, 50100	≤ 275 Bhn or ≤ 28 HRc	230 (184-276)	RPM	56230	28115	14058	7029	3514	2343	1757
				Fr	0.00019	0.0004	0.0007	0.0015	0.0030	0.0045	0.0060
				Feed (ipm)	10.5	10.5	10.5	10.5	10.5	10.5	10.5
≤ 375 Bhn or ≤ 40 HRc		145 (116-174)	RPM	35450	17725	8862	4431	2216	1477	1108	
			Fr	0.00019	0.0004	0.0007	0.0015	0.0030	0.0045	0.0060	
			Feed (ipm)	6.6	6.6	6.6	6.6	6.6	6.6	6.6	
≤ 450 Bhn or ≤ 48 HRc		60 (48-72)	RPM	14669	7334	3667	1834	917	611	458	
			Fr	0.00008	0.0002	0.0003	0.0007	0.0013	0.0020	0.0026	
			Feed (ipm)	1.2	1.2	1.2	1.2	1.2	1.2	1.2	
K TOOL STEELS A2, D2, H13, L2, M2, P20, S7, T15, W2		≤ 250 Bhn or ≤ 24 HRc	85 (68-102)	RPM	20781	10390	5195	2598	1299	866	649
				Fr	0.00011	0.0002	0.0004	0.0009	0.0018	0.0027	0.0035
				Feed (ipm)	2.3	2.3	2.3	2.3	2.3	2.3	2.3
	≤ 375 Bhn or ≤ 40 HRc	55 (44-66)	RPM	13446	6723	3362	1681	840	560	420	
			Fr	0.00005	0.0001	0.0002	0.0004	0.0008	0.0012	0.0017	
			Feed (ipm)	0.7	0.7	0.7	0.7	0.7	0.7	0.7	
	≤ 475 Bhn or ≤ 50 HRc	40 (32-48)	RPM	9779	4890	2445	1222	611	407	306	
			Fr	0.00005	0.0001	0.0002	0.0004	0.0008	0.0012	0.0016	
			Feed (ipm)	0.5	0.5	0.5	0.5	0.5	0.5	0.5	
	M CAST IRONS Gray, Malleable, Ductile	≤ 220 Bhn or ≤ 19 HRc	280 (224-336)	RPM	68454	34227	17114	8557	4278	2852	2139
				Fr	0.00026	0.0005	0.0010	0.0020	0.0041	0.0061	0.0082
				Feed (ipm)	17.5	17.5	17.5	17.5	17.5	17.5	17.5
≤ 330 Bhn or ≤ 36 HRc		250 (200-300)	RPM	61120	30560	15280	7640	3820	2547	1910	
			Fr	0.00025	0.0005	0.0010	0.0020	0.0041	0.0061	0.0081	
			Feed (ipm)	15.5	15.5	15.5	15.5	15.5	15.5	15.5	
M STAINLESS STEELS (FREE MACHINING) 303, 416, 420F, 430F 440F		≤ 250 Bhn or ≤ 24 HRc	210 (168-252)	RPM	51341	25670	12835	6418	3209	2139	1604
				Fr	0.00015	0.0003	0.0006	0.0012	0.0024	0.0036	0.0048
				Feed (ipm)	7.7	7.7	7.7	7.7	7.7	7.7	7.7
		≤ 330 Bhn or ≤ 36 HRc	110 (88-132)	RPM	26893	13446	6723	3362	1681	1121	840
				Fr	0.00009	0.0002	0.0004	0.0007	0.0015	0.0022	0.0030
				Feed (ipm)	2.5	2.5	2.5	2.5	2.5	2.5	2.5
	M STAINLESS STEELS (DIFFICULT) 304, 316, 321, 13-8 PH, 15-5PH, 17-4 PH, Custom 450	≤ 275 Bhn or ≤ 28 HRc	65 (52-78)	RPM	15891	7946	3973	1986	993	662	497
				Fr	0.00010	0.0002	0.0005	0.0009	0.0018	0.0025	0.0035
				Feed (ipm)	1.7	1.7	1.7	1.7	1.7	1.7	1.7
		≤ 375 Bhn or ≤ 40 HRc	55 (44-66)	RPM	13446	6723	3362	1681	840	560	420
				Fr	0.00010	0.0002	0.0004	0.0008	0.0015	0.0023	0.0031
				Feed (ipm)	1.3	1.3	1.3	1.3	1.3	1.3	1.3

continued on next page

FRACTIONAL 2 Flute Drills

Series 101 Fractional	Hardness	Vc (sfm)	Diameter (D ₁) (inch)								
			1/64	1/32	1/16	1/8	1/4	3/8	1/2		
SUPER ALLOYS (NICKEL, COBALT, IRON BASE) Inconel 601, 617, 625, Incoloy 800, Monel 400, Rene, Waspaloy	≤ 220 Bhn or ≤ 19 HRc	40 (32-48)	RPM	9779	4890	2445	1222	611	407	306	
			Fr	0.00010	0.0002	0.0004	0.0008	0.0016	0.0025	0.0033	
			Feed (ipm)	1.0	1.0	1.0	1.0	1.0	1.0	1.0	
	≤ 320 Bhn or ≤ 34 HRc	25 (20-30)	RPM	6112	3056	1528	764	382	255	191	
			Fr	0.00010	0.0002	0.0004	0.0008	0.0016	0.0024	0.0031	
			Feed (ipm)	0.6	0.6	0.6	0.6	0.6	0.6	0.6	
	≤ 425 Bhn or ≤ 45 HRc	20 (16-24)	RPM	4890	2445	1222	611	306	204	153	
			Fr	0.00004	0.0001	0.0002	0.0003	0.0007	0.0010	0.0013	
			Feed (ipm)	0.2	0.2	0.2	0.2	0.2	0.2	0.2	
	TITANIUM ALLOYS (DIFFICULT) Pure Titanium, Ti6Al4V, Ti6Al2Sn4Zr2Mo, Ti4Al4Mo2Sn0.5Si, Ti-6Al4V	≤ 275 Bhn or ≤ 28 HRc	85 (68-102)	RPM	20781	10390	5195	2598	1299	866	649
				Fr	0.00020	0.0004	0.0008	0.0016	0.0032	0.0049	0.0065
				Feed (ipm)	4.2	4.2	4.2	4.2	4.2	4.2	4.2
≤ 350 Bhn or ≤ 38 HRc		65 (52-78)	RPM	15891	7946	3973	1986	993	662	497	
			Fr	0.00011	0.0002	0.0004	0.0009	0.0017	0.0026	0.0034	
			Feed (ipm)	1.7	1.7	1.7	1.7	1.7	1.7	1.7	
≤ 440 Bhn or ≤ 47 HRc		55 (44-66)	RPM	13446	6723	3362	1681	840	560	420	
			Fr	0.00010	0.0002	0.0004	0.0008	0.0015	0.0023	0.0031	
			Feed (ipm)	1.3	1.3	1.3	1.3	1.3	1.3	1.3	
ALUMINUM ALLOYS 2017, 2024, 356, 6061, 7075		≤ 80 Bhn or ≤ 47 HRb	540 (432-648)	RPM	132019	66010	33005	16502	8251	5501	4126
				Fr	0.00030	0.0006	0.0012	0.0024	0.0048	0.0073	0.0097
				Feed (ipm)	40.0	40.0	40.0	40.0	40.0	40.0	40.0
	≤ 150 Bhn or ≤ 7 HRc	455 (364-546)	RPM	111238	55619	27810	13905	6952	4635	3476	
			Fr	0.00031	0.0006	0.0013	0.0025	0.0050	0.0076	0.0101	
			Feed (ipm)	35.0	35.0	35.0	35.0	35.0	35.0	35.0	
	COPPER ALLOYS Alum Bronze, C110, Muntz Brass	≤ 140 Bhn or ≤ 3 HRc	190 (152-228)	RPM	46451	23226	11613	5806	2903	1935	1452
				Fr	0.00015	0.0003	0.0006	0.0012	0.0024	0.0036	0.0048
				Feed (ipm)	7.0	7.0	7.0	7.0	7.0	7.0	7.0
		≤ 200 Bhn or ≤ 23 HRc	175 (140-210)	RPM	42784	21392	10696	5348	2674	1783	1337
				Fr	0.00015	0.0003	0.0006	0.0012	0.0024	0.0036	0.0048
				Feed (ipm)	6.4	6.4	6.4	6.4	6.4	6.4	6.4
PLASTICS Polycarbonate, PVC	500 (400-600)	RPM	122240	61120	30560	15280	7640	5093	3820		
		Fr	0.00031	0.0006	0.0012	0.0025	0.0050	0.0075	0.0099		
			Feed (ipm)	38.0	38.0	38.0	38.0	38.0	38.0	38.0	

Bhn (Brinell) HRc (Rockwell C) HRb (Rockwell B)

$$\text{rpm} = \text{Vc} \times 3.82 / D_1$$

$$\text{ipm} = \text{Fr} \times \text{rpm}$$

reduce speed and feed 30 percent when using uncoated drills

reduce speed and feed for materials harder than listed

refer to the KYOCERA SGS Tool Wizard® for complete technical information (www.kyocera-sgstool.com)

2 Flute Drills

Short Length Self Centering Drills • DIN 6539

Series 101M, 108M Metric	Hardness	Vc (m/min)	Diameter (D ₁) (mm)									
			1	3	6	8	10	12	16			
P	CARBON STEELS 1018, 1040, 1080, 1090, 10L50, 1140, 1212, 12L15, 1525, 1536	≤ 175 Bhn or ≤ 7 HRc	81	RPM	25690	8563	4282	3211	2569	2141	1606	
			(65-97)	Fr	0.014	0.041	0.082	0.109	0.136	0.163	0.218	
			Feed (mm/min)	350	350	350	350	350	350	350		
		≤ 300 Bhn or ≤ 32 HRc	38	RPM	12118	4039	2020	1515	1212	1010	757	
			(30-46)	Fr	0.012	0.036	0.072	0.096	0.120	0.144	0.191	
			Feed (mm/min)	145	145	145	145	145	145	145		
	≤ 425 Bhn or ≤ 45 HRc	26	RPM	8240	2747	1373	1030	824	687	515		
		(21-31)	Fr	0.007	0.020	0.040	0.053	0.067	0.080	0.107		
		Feed (mm/min)	55	55	55	55	55	55	55			
	ALLOY STEELS 4140, 4150, 4320, 5120, 5150, 8630, 86L20, 50100	≤ 275 Bhn or ≤ 28 HRc	70	RPM	22297	7432	3716	2787	2230	1858	1394	
			(56-84)	Fr	0.012	0.036	0.073	0.097	0.121	0.145	0.194	
			Feed (mm/min)	270	270	270	270	270	270	270		
≤ 375 Bhn or ≤ 40 HRc		44	RPM	14057	4686	2343	1757	1406	1171	879		
		(35-53)	Fr	0.012	0.036	0.073	0.097	0.121	0.145	0.194		
		Feed (mm/min)	170	170	170	170	170	170	170			
≤ 450 Bhn or ≤ 48 HRc	18	RPM	5816	1939	969	727	582	485	364			
	(15-22)	Fr	0.005	0.015	0.030	0.040	0.050	0.060	0.080			
	Feed (mm/min)	29	29	29	29	29	29	29				
H	TOOL STEELS A2, D2, H13, L2, M2, P20, S7, T15, W2	≤ 250 Bhn or ≤ 24 HRc	26	RPM	8240	2747	1373	1030	824	687	515	
			(21-31)	Fr	0.007	0.020	0.040	0.053	0.067	0.080	0.107	
			Feed (mm/min)	55	55	55	55	55	55	55		
		≤ 375 Bhn or ≤ 40 HRc	17	RPM	5332	1777	889	666	533	444	333	
			(13-20)	Fr	0.003	0.010	0.020	0.027	0.034	0.041	0.054	
			Feed (mm/min)	18	18	18	18	18	18	18		
	≤ 475 Bhn or ≤ 50 HRc	12	RPM	3878	1293	646	485	388	323	242		
		(10-15)	Fr	0.003	0.009	0.019	0.025	0.031	0.037	0.050		
		Feed (mm/min)	12	12	12	12	12	12	12			
	K	CAST IRONS Gray, Malleable, Ductile	≤ 220 Bhn or ≤ 19 HRc	85	RPM	27144	9048	4524	3393	2714	2262	1696
				(68-102)	Fr	0.016	0.049	0.097	0.130	0.162	0.195	0.259
				Feed (mm/min)	440	440	440	440	440	440	440	
≤ 330 Bhn or ≤ 36 HRc			76	RPM	24235	8078	4039	3029	2424	2020	1515	
			(61-91)	Fr	0.017	0.050	0.099	0.132	0.165	0.198	0.264	
			Feed (mm/min)	400	400	400	400	400	400	400		
M	STAINLESS STEELS (FREE MACHINING) 303, 416, 420F, 430F 440F	≤ 250 Bhn or ≤ 24 HRc	64	RPM	20358	6786	3393	2545	2036	1696	1272	
			(51-77)	Fr	0.010	0.029	0.059	0.079	0.098	0.118	0.157	
			Feed (mm/min)	200	200	200	200	200	200	200		
		≤ 330 Bhn or ≤ 36 HRc	34	RPM	10664	3555	1777	1333	1066	889	666	
			(27-40)	Fr	0.006	0.017	0.034	0.045	0.056	0.068	0.090	
			Feed (mm/min)	60	60	60	60	60	60	60		
	STAINLESS STEELS (DIFFICULT) 304, 316, 321, 13-8 PH, 15-5PH, 17-4 PH, Custom 450	≤ 275 Bhn or ≤ 28 HRc	20	RPM	6301	2100	1050	788	630	525	394	
			(16-24)	Fr	0.007	0.021	0.043	0.057	0.071	0.086	0.114	
			Feed (mm/min)	45	45	45	45	45	45	45		
		≤ 375 Bhn or ≤ 40 HRc	17	RPM	5332	1777	889	666	533	444	333	
			(13-20)	Fr	0.007	0.020	0.039	0.053	0.066	0.079	0.105	
			Feed (mm/min)	35	35	35	35	35	35	35		

continued on next page

2 Flute Drills

Short Length Self Centering Drills • DIN 6539

Series 101M, 108M Metric	Hardness	Vc (m/min)	Diameter (D ₁) (mm)							
			1	3	6	8	10	12	16	
S SUPER ALLOYS (NICKEL, COBALT, IRON BASE) Inconel 601, 617, 625, Incoloy 800, Monel 400, Rene, Waspaloy	≤ 220 Bhn or ≤ 19 HRc	12 (10-15)	RPM	3878	1293	646	485	388	323	242
			Fr	0.006	0.019	0.039	0.052	0.064	0.077	0.103
			Feed (mm/min)	25	25	25	25	25	25	25
	≤ 320 Bhn or ≤ 34 HRc	8 (6-9)	RPM	2424	808	404	303	242	202	151
			Fr	0.006	0.019	0.037	0.050	0.062	0.074	0.099
			Feed (mm/min)	15	15	15	15	15	15	15
	≤ 425 Bhn or ≤ 45 HRc	6 (5-7)	RPM	1939	646	323	242	194	162	121
			Fr	0.005	0.015	0.031	0.041	0.052	0.062	0.083
			Feed (mm/min)	10	10	10	10	10	10	10
S TITANIUM ALLOYS (DIFFICULT) Pure Titanium, Ti6Al4V, Ti6Al2Sn4Zr2Mo, Ti4Al4Mo2Sn0.5Si, Ti-6Al4V	≤ 275 Bhn or ≤ 28 HRc	26 (21-31)	RPM	8240	2747	1373	1030	824	687	515
			Fr	0.013	0.040	0.080	0.107	0.133	0.160	0.214
			Feed (mm/min)	110	110	110	110	110	110	110
	≤ 350 Bhn or ≤ 38 HRc	20 (16-24)	RPM	6301	2100	1050	788	630	525	394
			Fr	0.007	0.021	0.043	0.057	0.071	0.086	0.114
			Feed (mm/min)	45	45	45	45	45	45	45
	≤ 440 Bhn or ≤ 47 HRc	17 (13-20)	RPM	5332	1777	889	666	533	444	333
			Fr	0.007	0.020	0.039	0.053	0.066	0.079	0.105
			Feed (mm/min)	35	35	35	35	35	35	35
N ALUMINUM ALLOYS 2017, 2024, 356, 6061, 7075	≤ 80 Bhn or ≤ 47 HRb	165 (132-198)	RPM	52348	17449	8725	6544	5235	4362	3272
			Fr	0.020	0.060	0.120	0.160	0.200	0.240	0.319
			Feed (mm/min)	1045	1045	1045	1045	1045	1045	1045
	≤ 150 Bhn or ≤ 7 HRc	139 (111-166)	RPM	44108	14703	7351	5514	4411	3676	2757
			Fr	0.020	0.060	0.120	0.160	0.200	0.239	0.319
			Feed (mm/min)	880	880	880	880	880	880	880
	≤ 140 Bhn or ≤ 3 HRc	58 (46-69)	RPM	18419	6140	3070	2302	1842	1535	1151
			Fr	0.010	0.030	0.060	0.080	0.100	0.121	0.161
			Feed (mm/min)	185	185	185	185	185	185	185
≤ 200 Bhn or ≤ 23 HRc	53 (43-64)	RPM	16965	5655	2827	2121	1696	1414	1060	
		Fr	0.010	0.030	0.060	0.080	0.100	0.120	0.160	
		Feed (mm/min)	170	170	170	170	170	170	170	
PLASTICS Polycarbonate, PVC	152 (122-183)	RPM	48471	16157	8078	6059	4847	4039	3029	
		Fr	0.020	0.060	0.120	0.160	0.200	0.240	0.320	
		Feed (mm/min)	970	970	970	970	970	970	970	

Bhn (Brinell) HRc (Rockwell C) HRb (Rockwell B)

$$rpm = (Vc \times 1000) / (D_1 \times 3.14)$$

$$mm/min = Fr \times rpm$$

reduce speed and feed 30 percent when using uncoated drills

reduce speed and feed for materials harder than listed

refer to the KYOCERA SGS Tool Wizard® for complete technical information (www.kyocera-sgstool.com)

Straight Flute Drills • Metric: DIN 6539



3xD



106

FRACTIONAL & METRIC SERIES

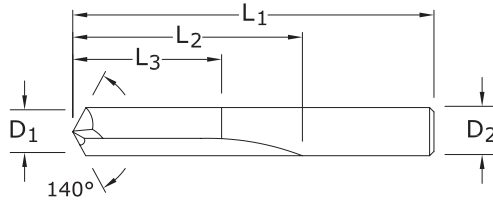

CUTTING DIAMETER D ₁ /D ₂	DECIMAL EQUIV.	METRIC EQUIV.	OVERALL LENGTH L ₁	FLUTE LENGTH L ₂	CLEARED LENGTH L ₃	EDP NO.	
						UNCOATED	Ti-NAMITE-A (AITiN)
1,0 mm	0.0394		26,0	6,0	4,5	66001	66002
#60	0.0400	1.02	1-1/2	1/2	13/32	56060	56269
#59	0.0410	1.04	1-1/2	1/2	13/32	56059	56268
#58	0.0420	1.07	1-1/2	1/2	13/32	56058	56267
#57	0.0430	1.09	1-1/2	1/2	13/32	56057	56266
#56	0.0465	1.18	1-1/2	1/2	13/32	56056	56265
3/64	0.0469	1.19	1-1/2	1/2	13/32	56103	56135
#55	0.0520	1.32	1-1/2	1/2	13/32	56055	56264
#54	0.0550	1.40	1-1/2	1/2	13/32	56054	56263
1,5 mm	0.0591		32,0	9,0	7,0	66003	66004
#53	0.0595	1.51	1-1/2	1/2	13/32	56053	56262
1/16	0.0625	1.59	1-1/2	5/8	1/2	56104	56136
#52	0.0635	1.61	1-11/16	11/16	35/64	56052	56261
#51	0.0670	1.70	1-11/16	11/16	35/64	56051	56260
#50	0.0700	1.78	1-11/16	11/16	35/64	56050	56259
#49	0.0730	1.85	1-11/16	11/16	35/64	56049	56258
#48	0.0760	1.93	1-11/16	11/16	35/64	56048	56257
5/64	0.0781	1.98	1-11/16	11/16	35/64	56105	56137
#47	0.0785	1.99	1-3/4	3/4	39/64	56047	56256
2,0 mm	0.0787		38,0	12,0	9,0	66005	66006
#46	0.0810	2.06	1-3/4	3/4	39/64	56046	56255
#45	0.0820	2.08	1-3/4	3/4	39/64	56045	56254
#44	0.0860	2.18	1-3/4	3/4	39/64	56044	56253
#43	0.0890	2.26	1-3/4	3/4	39/64	56043	56252
#42	0.0935	2.37	1-3/4	3/4	39/64	56042	56251
3/32	0.0938	2.38	1-3/4	3/4	39/64	56106	56138
#41	0.0960	2.44	1-13/16	13/16	21/32	56041	56250
#40	0.0980	2.49	1-13/16	13/16	21/32	56040	56249
2,5 mm	0.0984		43,0	14,0	11,0	66007	66008
#39	0.0995	2.53	1-13/16	13/16	21/32	56039	56248
#38	0.1015	2.58	1-13/16	13/16	21/32	56038	56247
#37	0.1040	2.64	1-13/16	13/16	21/32	56037	56246
#36	0.1065	2.71	1-13/16	13/16	21/32	56036	56245
7/64	0.1094	2.78	1-13/16	13/16	21/32	56107	56139
#35	0.1100	2.79	1-7/8	7/8	45/64	56035	56244
#34	0.1110	2.82	1-7/8	7/8	45/64	56034	56243

TOLERANCES (inch)

D₁ = +.0000/-0.0005
D₂ = h6

TOLERANCES (mm)

D₁ = +0,0000/-0,0127
D₂ = h6

- STEELS
- CAST IRON
- HARDENED STEELS

For patent information visit www.ksptpatents.com

continued on next page

Straight Flute Drills • Metric: DIN 6539

106

FRACTIONAL & METRIC SERIES

CUTTING DIAMETER D ₁ /D ₂	DECIMAL EQUIV.	METRIC EQUIV.	OVERALL LENGTH L ₁	FLUTE LENGTH L ₂	CLEARED LENGTH L ₃	EDP NO.	
						UNCOATED	Ti-NAMITE-A (AITiN)
#33	0.1130	2.87	1-7/8	7/8	45/64	56033	56242
#32	0.1160	2.95	1-7/8	7/8	45/64	56032	56241
3,0 mm	0.1181		46,0	16,0	12,0	66009	66010
#31	0.1200	3.05	1-7/8	7/8	45/64	56031	56240
1/8	0.1250	3.18	1-7/8	7/8	45/64	56108	56140
#30	0.1285	3.26	1-15/16	15/16	3/4	56030	56239
#29	0.1360	3.45	1-15/16	15/16	3/4	56029	56238
3,5 mm	0.1378		52,0	20,0	15,0	66011	66012
#28	0.1405	3.57	1-15/16	15/16	3/4	56028	56237
9/64	0.1406	3.57	1-15/16	15/16	3/4	56109	56141
#27	0.1440	3.66	2-1/16	1	51/64	56027	56236
#26	0.1470	3.73	2-1/16	1	51/64	56026	56235
#25	0.1495	3.80	2-1/16	1	51/64	56025	56234
#24	0.1520	3.86	2-1/16	1	51/64	56024	56233
#23	0.1540	3.91	2-1/16	1	51/64	56023	56232
5/32	0.1562	3.97	2-1/16	1	51/64	56110	56142
#22	0.1570	3.99	2-1/8	1-1/16	55/64	56022	56231
4,0 mm	0.1575		55,0	22,0	17,0	66013	66014
#21	0.1590	4.04	2-1/8	1-1/16	55/64	56021	56230
#20	0.1610	4.09	2-1/8	1-1/16	55/64	56020	56229
#19	0.1660	4.22	2-1/8	1-1/16	55/64	56019	56228
#18	0.1695	4.31	2-1/8	1-1/16	55/64	56018	56227
11/64	0.1719	4.37	2-1/8	1-1/16	55/64	56111	56143
#17	0.1730	4.39	2-3/16	1-1/8	29/32	56017	56226
#16	0.1770	4.50	2-3/16	1-1/8	29/32	56016	56225
4,5 mm	0.1772		58,0	24,0	18,0	66015	66016
#15	0.1800	4.57	2-3/16	1-1/8	29/32	56015	56224
#14	0.1820	4.62	2-3/16	1-1/8	29/32	56014	56223
#13	0.1850	4.70	2-3/16	1-1/8	29/32	56013	56222
3/16	0.1875	4.76	2-3/16	1-1/8	29/32	56112	56144
#12	0.1890	4.80	2-3/16	1-1/8	29/32	56012	56221
#11	0.1910	4.85	2-3/16	1-1/8	29/32	56011	56220
#10	0.1935	4.91	2-3/16	1-1/8	29/32	56010	56219
#9	0.1960	4.98	2-1/4	1-3/16	61/64	56009	56218
5,0 mm	0.1969		62,0	26,0	20,0	66017	66018
#8	0.1990	5.05	2-1/4	1-3/16	61/64	56008	56217
#7	0.2010	5.11	2-1/4	1-3/16	61/64	56007	56216
13/64	0.2031	5.16	2-1/4	1-3/16	61/64	56113	56145
#6	0.2040	5.18	2-3/8	1-1/4	1	56006	56215
#5	0.2055	5.22	2-3/8	1-1/4	1	56005	56214
#4	0.2090	5.31	2-3/8	1-1/4	1	56004	56213
#3	0.2130	5.41	2-3/8	1-1/4	1	56003	56212
5,5 mm	0.2165		66,0	28,0	21,0	66019	66020
7/32	0.2188	5.56	2-3/8	1-1/4	1	56114	56146
#2	0.2210	5.61	2-7/16	1-5/16	1-3/64	56002	56211
#1	0.2280	5.79	2-7/16	1-5/16	1-3/64	56001	56210

continued on next page

CONTINUED

Straight Flute Drills • Metric: DIN 6539



3xD

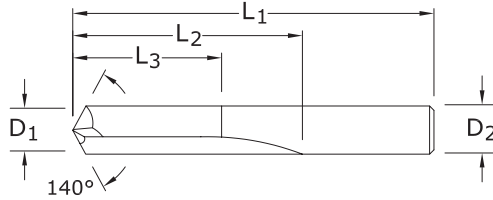

106

FRACTIONAL & METRIC SERIES

CUTTING DIAMETER D ₁ / D ₂	DECIMAL EQUIV.	METRIC EQUIV.	OVERALL LENGTH L ₁	FLUTE LENGTH L ₂	CLEARED LENGTH L ₃	EDP NO.	
						UNCOATED	Ti-NAMITE-A (AITIN)
15/64	0.2344	5.95	2-7/16	1-5/16	1-3/64	56115	56147
6,0 mm	0.2362		66,0	28,0	21,0	66021	66045
1/4	0.2500	6.35	2-1/2	1-3/8	1-7/64	56116	56148
6,5 mm	0.2559		70,0	31,0	23,0	66022	66046
17/64	0.2656	6.75	2-5/8	1-7/16	1-7/64	56117	56149
7,0 mm	0.2756		74,0	34,0	25,0	66023	66024
9/32	0.2812	7.14	2-11/16	1-1/2	1-13/64	56118	56150
7,5 mm	0.2953		74,0	34,0	25,0	66025	66026
19/64	0.2969	7.54	2-3/4	1-9/16	1-1/4	56119	56151
5/16	0.3125	7.94	2-13/16	1-5/8	1-19/64	56120	56152
8,0 mm	0.3150		79,0	37,0	27,0	66027	66028
21/64	0.3281	8.33	2-15/16	1-11/16	1-23/64	56121	56153
8,5 mm	0.3346		79,0	37,0	27,0	66029	66030
11/32	0.3438	8.73	3	1-11/16	1-23/64	56122	56154
9,0 mm	0.3543		84,0	40,0	29,0	66031	66032
23/64	0.3594	9.13	3-1/16	1-3/4	1-13/32	56123	56155
9,5 mm	0.3740		84,0	40,0	29,0	66033	66034
3/8	0.3750	9.53	3-1/8	1-13/16	1-29/64	56124	56156
25/64	0.3906	9.92	3-1/4	1-7/8	1-1/2	56125	56157
10,0 mm	0.3937		89,0	43,0	31,0	66035	66036
13/32	0.4062	10.32	3-5/16	1-15/16	1-35/64	56126	56158
10,5 mm	0.4134		89,0	43,0	31,0	66037	66038
27/64	0.4219	10.72	3-3/8	2	1-39/64	56127	56159
11,0 mm	0.4331		95,0	47,0	33,0	66039	66040
7/16	0.4375	11.11	3-7/16	2-1/16	1-21/32	56128	56160
11,5 mm	0.4528		95,0	47,0	33,0	66041	66042
29/64	0.4531	11.51	3-9/16	2-1/8	1-45/64	56129	56161
15/32	0.4688	11.91	3-5/8	2-1/8	1-45/64	56130	56162
12,0 mm	0.4724		102,0	51,0	35,0	66043	66044
31/64	0.4844	12.30	3-11/16	2-3/16	1-3/4	56131	56163
1/2	0.5000	12.70	3-3/4	2-1/4	1-51/64	56132	56164

TOLERANCES (inch)

D₁ = +.0000/- .0005
D₂ = h6

TOLERANCES (mm)

D₁ = +0,0000/-0,0127
D₂ = h6

STEELS

CAST IRON

HARDENED STEELS

For patent information visit www.ksptpatents.com

FRACTIONAL & METRIC
Straight Flute Drills

Series 106 Fractional	Hardness	Vc (sfm)	Diameter (D ₁) (inch)						
			1/16	1/8	3/16	1/4	3/8	1/2	
P ALLOY STEELS 4140, 4150, 4320, 5120, 5150, 8630, 86L20, 50100	≤ 500 Bhn or ≤ 52 HRc	60 (48-72)	RPM	3667	1834	1222	917	611	458
			Fr	0.0004	0.0007	0.0011	0.0014	0.0021	0.0028
			Feed (ipm)	1.3	1.3	1.3	1.3	1.3	1.3
	≤ 615 Bhn or ≤ 58 HRc	50 (40-60)	RPM	3056	1528	1019	764	509	382
			Fr	0.0004	0.0008	0.0012	0.0016	0.0024	0.0031
			Feed (ipm)	1.2	1.2	1.2	1.2	1.2	1.2
H TOOL STEELS A2, D2, H13, L2, M2, P20, S7, T15, W2	≤ 500 Bhn or ≤ 52 HRc	60 (48-72)	RPM	3667	1834	1222	917	611	458
			Fr	0.0004	0.0007	0.0011	0.0014	0.0021	0.0028
			Feed (ipm)	1.3	1.3	1.3	1.3	1.3	1.3
	≤ 615 Bhn or ≤ 58 HRc	50 (40-60)	RPM	3056	1528	1019	764	509	382
			Fr	0.0004	0.0008	0.0012	0.0016	0.0024	0.0031
			Feed (ipm)	1.2	1.2	1.2	1.2	1.2	1.2
K CAST IRONS Gray, Malleable, Ductile	≤ 220 Bhn or ≤ 19 HRc	250 (200-300)	RPM	15280	7640	5093	3820	2547	1910
			Fr	0.0010	0.0020	0.0030	0.0041	0.0061	0.0081
			Feed (ipm)	15.5	15.5	15.5	15.5	15.5	15.5
	≤ 330 Bhn or ≤ 36 HRc	195 (156-234)	RPM	11918	5959	3973	2980	1986	1490
			Fr	0.0010	0.0020	0.0030	0.0040	0.0060	0.0081
			Feed (ipm)	12.0	12.0	12.0	12.0	12.0	12.0

Bhn (Brinell) HRc (Rockwell C)
 $rpm = Vc \times 3.82 / D_1$
 $ipm = Fr \times rpm$
 reduce speed and feed 30 percent when using uncoated drills
 refer to the KYOCERA SGS Tool Wizard® for complete technical information (www.kyocera-sgstool.com)

Series 106M Metric	Hardness	Vc (m/min)	Diameter (D ₁) (mm)						
			1	3	6	8	10	12	
P ALLOY STEELS 4140, 4150, 4320, 5120, 5150, 8630, 86L20, 50100	≤ 500 Bhn or ≤ 52 HRc	18 (15-22)	RPM	5816	1939	969	727	582	485
			Fr	0.006	0.018	0.035	0.047	0.058	0.070
			Feed (mm/min)	34	34	34	34	34	34
	≤ 615 Bhn or ≤ 58 HRc	15 (12-18)	RPM	4847	1616	808	606	485	404
			Fr	0.006	0.017	0.033	0.045	0.056	0.067
			Feed (mm/min)	27	27	27	27	27	27
H TOOL STEELS A2, D2, H13, L2, M2, P20, S7, T15, W2	≤ 500 Bhn or ≤ 52 HRc	18 (15-22)	RPM	5816	1939	969	727	582	485
			Fr	0.006	0.018	0.035	0.047	0.058	0.070
			Feed (mm/min)	34	34	34	34	34	34
	≤ 615 Bhn or ≤ 58 HRc	15 (12-18)	RPM	4847	1616	808	606	485	404
			Fr	0.006	0.017	0.033	0.045	0.056	0.067
			Feed (mm/min)	27	27	27	27	27	27
K CAST IRONS Gray, Malleable, Ductile	≤ 220 Bhn or ≤ 19 HRc	76 (61-91)	RPM	24235	8078	4039	3029	2424	2020
			Fr	0.016	0.048	0.096	0.128	0.160	0.192
			Feed (mm/min)	395	395	395	395	395	395
	≤ 330 Bhn or ≤ 36 HRc	59 (48-71)	RPM	18904	6301	3151	2363	1890	1575
			Fr	0.016	0.048	0.096	0.128	0.160	0.192
			Feed (mm/min)	305	305	305	305	305	305

Bhn (Brinell) HRc (Rockwell C)
 $rpm = (Vc \times 1000) / (D_1 \times 3.14)$
 $mm/min = Fr \times rpm$
 reduce speed and feed 30 percent when using uncoated drills
 refer to the KYOCERA SGS Tool Wizard® for complete technical information (www.kyocera-sgstool.com)

3 Flute Drills • Metric: DIN 6539



3xD
(mm)

5xD
(inch)



3

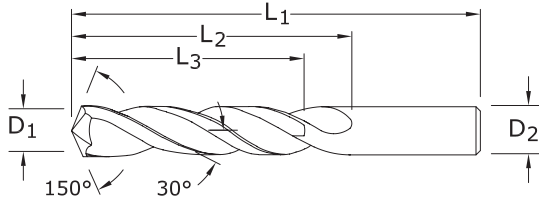

103

FRACTIONAL & METRIC SERIES

CUTTING DIAMETER D ₁ /D ₂	DECIMAL EQUIV.	METRIC EQUIV.	OVERALL LENGTH L ₁	FLUTE LENGTH L ₂	CLEARED LENGTH L ₃	EDP NO.	
						UNCOATED	Ti-NAMITE-A (AITiN)
#36	0.1065	2.71	2-1/4	1-1/4	1	53036	58011
7/64	0.1094	2.78	2-1/4	1-1/4	1	53107	58012
#35	0.1100	2.79	2-1/4	1-1/4	1	53035	58013
#34	0.1110	2.82	2-1/4	1-1/4	1	53034	58014
#33	0.1130	2.87	2-1/4	1-1/4	1	53033	58015
#32	0.1160	2.95	2-1/4	1-1/4	1	53032	58016
3,0 mm	0.1181		46,0	16,0	12,0	63000	68965
#31	0.1200	3.05	2-1/4	1-1/4	1	53031	58017
3,1 mm	0.1220		49,0	18,0	14,0	63044	68966
1/8	0.1250	3.18	2-1/4	1-1/4	1	53108	58018
3,2 mm	0.1260		49,0	18,0	14,0	63045	68967
#30	0.1285	3.26	2-1/4	1-1/4	1	53030	58019
3,3 mm	0.1299		49,0	18,0	14,0	63001	68968
3,4 mm	0.1339		52,0	20,0	15,0	63046	68969
#29	0.1360	3.45	2-1/2	1-3/8	1-7/64	53029	58020
3,5 mm	0.1378		52,0	20,0	15,0	63002	68970
#28	0.1405	3.57	2-1/2	1-3/8	1-7/64	53028	58021
9/64	0.1406	3.57	2-1/2	1-3/8	1-7/64	53109	58022
3,6 mm	0.1417		52,0	20,0	15,0	63047	68971
#27	0.1440	3.66	2-1/2	1-3/8	1-7/64	53027	58023
3,7 mm	0.1457		52,0	20,0	15,0	63003	68972
#26	0.1470	3.73	2-1/2	1-3/8	1-7/64	53026	58024
#25	0.1495	3.80	2-1/2	1-3/8	1-7/64	53025	58025
3,8 mm	0.1496		55,0	22,0	17,0	63048	68973
#24	0.1520	3.86	2-1/2	1-3/8	1-7/64	53024	58026
3,9 mm	0.1535		55,0	22,0	17,0	63049	68974
#23	0.1540	3.91	2-1/2	1-3/8	1-7/64	53023	58027
5/32	0.1562	3.97	2-1/2	1-3/8	1-7/64	53110	58028
#22	0.1570	3.99	2-1/2	1-3/8	1-7/64	53022	58029
4,0 mm	0.1575		55,0	22,0	17,0	63004	68975
#21	0.1590	4.04	2-1/2	1-3/8	1-7/64	53021	58030
#20	0.1610	4.09	2-1/2	1-3/8	1-7/64	53020	58031
4,1 mm	0.1614		55,0	22,0	17,0	63050	68976
4,2 mm	0.1654		55,0	22,0	17,0	63005	68977
#19	0.1660	4.22	2-3/4	1-5/8	1-19/64	53019	58032
4,3 mm	0.1693		58,0	24,0	18,0	63051	68978
#18	0.1695	4.31	2-3/4	1-5/8	1-19/64	53018	58033
11/64	0.1719	4.37	2-3/4	1-5/8	1-19/64	53111	58034
#17	0.1730	4.39	2-3/4	1-5/8	1-19/64	53017	58035
4,4 mm	0.1732		58,0	24,0	18,0	63052	68979

TOLERANCES (inch)

D₁ = +.0000/-0.0005
D₂ = h6

TOLERANCES (mm)

D₁ = +0,0000/-0,0127
D₂ = h6

- STEELS
- CAST IRON
- HARDENED STEELS
- NON-FERROUS

For patent information visit www.ksptpatents.com

continued on next page

3 Flute Drills • Metric: DIN 6539

103

FRACTIONAL & METRIC SERIES

CONTINUED

CUTTING DIAMETER D ₁ /D ₂	DECIMAL EQUIV.	METRIC EQUIV.	OVERALL LENGTH L ₁	FLUTE LENGTH L ₂	CLEARED LENGTH L ₃	EDP NO.	
						UNCOATED	Ti-NAMITE-A (AlTiN)
#16	0.1770	4.50	2-3/4	1-5/8	1-19/64	53016	58036
4,5 mm	0.1772		58,0	24,0	18,0	63006	68980
#15	0.1800	4.57	2-3/4	1-5/18	1-19/64	53015	58037
4,6 mm	0.1811		58,0	24,0	18,0	63053	68981
#14	0.1820	4.62	2-3/4	1-5/8	1-19/64	53014	58038
#13	0.1850	4.70	2-3/4	1-5/8	1-19/64	53013	58039
4,7 mm	0.1850		58,0	24,0	18,0	63054	68982
3/16	0.1875	4.76	2-3/4	1-5/8	1-19/64	53112	58040
#12	0.1890	4.80	2-3/4	1-5/8	1-19/64	53012	58041
4,8 mm	0.1890		62,0	26,0	20,0	63055	68983
#11	0.1910	4.85	2-3/4	1-5/8	1-19/64	53011	58042
4,9 mm	0.1929		62,0	26,0	20,0	63056	68984
#10	0.1935	4.91	2-3/4	1-5/8	1-19/64	53010	58043
#9	0.1960	4.98	3	1-3/4	1-13/32	53009	58044
5,0 mm	0.1969		62,0	26,0	20,0	63007	68985
#8	0.1990	5.05	3	1-3/4	1-13/32	53008	58045
5,1 mm	0.2008		62,0	26,0	20,0	63057	68986
#7	0.2010	5.11	3	1-3/4	1-13/32	53007	58046
13/64	0.2031	5.16	3	1-3/4	1-13/32	53113	58047
#6	0.2040	5.18	3	1-3/4	1-13/32	53006	58048
5,2 mm	0.2047		62,0	26,0	20,0	63008	68987
#5	0.2055	5.22	3	1-3/4	1-13/32	53005	58049
5,3 mm	0.2087		62,0	26,0	20,0	63058	68988
#4	0.2090	5.31	3	1-3/4	1-13/32	53004	58050
5,4 mm	0.2126		66,0	28,0	21,0	63059	68989
#3	0.2130	5.41	3	1-3/4	1-13/32	53003	58051
5,5 mm	0.2165		66,0	28,0	21,0	63009	68990
7/32	0.2188	5.56	3	1-3/4	1-13/32	53114	58052
5,6 mm	0.2205		66,0	28,0	21,0	63060	68991
#2	0.2210	5.61	3	1-3/4	1-13/32	53002	58053
5,7 mm	0.2244		66,0	28,0	21,0	63061	68992
#1	0.2280	5.79	3	1-3/4	1-13/32	53001	58054
5,8 mm	0.2283		66,0	28,0	21,0	63062	68993
5,9 mm	0.2323		66,0	28,0	21,0	63063	68994
A	0.2340	5.94	3-1/4	2	1-39/64	53201	58055
15/64	0.2344	5.95	3-1/4	2	1-39/64	53115	58056
6,0 mm	0.2362		66,0	28,0	21,0	63010	68995
B	0.2380	6.05	3-1/4	2	1-39/64	53202	58057
6,1 mm	0.2402		70,0	31,0	23,0	63064	68996
C	0.2420	6.15	3-1/4	2	1-39/64	53203	58058
6,2 mm	0.2441		70,0	31,0	23,0	63011	68997
D	0.2460	6.25	3-1/4	2	1-39/64	53204	58059
6,3 mm	0.2480		70,0	31,0	23,0	63065	68998
1/4	0.2500	6.35	3-1/4	2	1-39/64	53116	58061
6,4 mm	0.2520		70,0	31,0	23,0	63066	68999
6,5 mm	0.2559		70,0	31,0	23,0	63012	69000
F	0.2570	6.53	3-1/4	2	1-39/64	53206	58062
6,6 mm	0.2598		70,0	31,0	23,0	63067	69001
G	0.2610	6.63	3-1/2	2-1/8	1-45/64	53207	58063
6,7 mm	0.2638		70,0	31,0	23,0	63068	69002

continued on next page

3 Flute Drills • Metric: DIN 6539



3xD
(mm)

5xD
(inch)



3

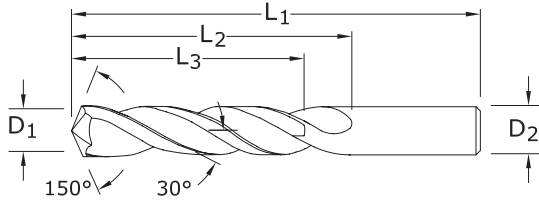

103

FRACTIONAL & METRIC SERIES

CUTTING DIAMETER D ₁ /D ₂	DECIMAL EQUIV.	METRIC EQUIV.	OVERALL LENGTH L ₁	FLUTE LENGTH L ₂	CLEARED LENGTH L ₃	EDP NO.	
						UNCOATED	Ti-NAMITE-A (AITiN)
17/64	0.2656	6.75	3-1/2	2-1/8	1-45/64	53117	58064
H	0.2660	6.76	3-1/2	2-1/8	1-45/64	53208	58065
6,8 mm	0.2677		74,0	34,0	25,0	63013	69003
6,9 mm	0.2717		74,0	34,0	25,0	63069	69004
I	0.2720	6.91	3-1/2	2-1/8	1-45/64	53209	58066
7,0 mm	0.2756		74,0	34,0	25,0	63014	69005
J	0.2770	7.04	3-1/2	2-1/8	1-45/64	53210	58067
7,1 mm	0.2795		74,0	34,0	25,0	63070	69006
K	0.2810	7.14	3-1/2	2-1/8	1-45/64	53211	58068
9/32	0.2812	7.14	3-1/2	2-1/8	1-45/64	53118	58069
7,2 mm	0.2835		74,0	34,0	25,0	63015	69007
7,3 mm	0.2874		74,0	34,0	25,0	63071	69008
L	0.2900	7.37	3-1/2	2-1/8	1-45/64	53212	58070
7,4 mm	0.2913		74,0	34,0	25,0	63072	69009
M	0.2950	7.49	3-3/4	2-3/8	1-29/32	53213	58071
7,5 mm	0.2953		74,0	34,0	25,0	63016	69010
19/64	0.2969	7.54	3-3/4	2-3/8	1-29/32	53119	58072
7,6 mm	0.2992		79,0	37,0	27,0	63073	69011
N	0.3020	7.67	2-3/8	2-3/8	1-29/32	53214	58073
7,7 mm	0.3031		79,0	37,0	27,0	63074	69012
7,8 mm	0.3071		79,0	37,0	27,0	63075	69013
7,9 mm	0.3110		79,0	37,0	27,0	63076	69014
5/16	0.3125	7.94	3-3/4	2-3/8	1-29/32	53120	58074
8,0 mm	0.3150		79,0	37,0	27,0	63017	69015
O	0.3160	8.03	3-3/4	2-3/8	1-29/32	53215	58075
8,1 mm	0.3189		79,0	37,0	27,0	63077	69016
8,2 mm	0.3228		79,0	37,0	27,0	63018	69017
P	0.3230	8.20	3-3/4	2-3/8	1-29/32	53216	58076
8,3 mm	0.3268		79,0	37,0	27,0	63078	69018
21/64	0.3281	8.33	4	2-1/2	2	53121	58077
8,4 mm	0.3307		79,0	37,0	27,0	63019	69019
Q	0.3320	8.43	4	2-1/2	2	53217	58078
8,5 mm	0.3346		79,0	37,0	27,0	63020	69020
8,6 mm	0.3386		84,0	40,0	29,0	63021	69021
R	0.3390	8.61	4	2-1/2	2	53218	58079
8,7 mm	0.3425		84,0	40,0	29,0	63079	69022
11/32	0.3438	8.73	4	2-1/2	2	53122	58080
8,8 mm	0.3465		84,0	40,0	29,0	63022	69023
S	0.3480	8.84	4	2-1/2	2	53219	58081
8,9 mm	0.3504		84,0	40,0	29,0	63080	69024
9,0 mm	0.3543		84,0	40,0	29,0	63023	69025
T	0.3580	9.09	4-1/4	2-3/4	2-13/64	53220	58082

continued on next page

TOLERANCES (inch)

D₁ = +.0000/-0.0005
D₂ = h6

TOLERANCES (mm)

D₁ = +0,0000/-0,0127
D₂ = h6

- STEELS
- CAST IRON
- HARDENED STEELS
- NON-FERROUS

For patent information visit www.ksptpatents.com

3 Flute Drills • Metric: DIN 6539

103

FRACTIONAL & METRIC SERIES

CONTINUED

CUTTING DIAMETER D ₁ /D ₂	DECIMAL EQUIV.	METRIC EQUIV.	OVERALL LENGTH L ₁	FLUTE LENGTH L ₂	CLEARED LENGTH L ₃	EDP NO.	
						UNCOATED	Ti-NAMITE-A (AITiN)
9,1 mm	0.3583		84,0	40,0	29,0	63081	69026
23/64	0.3594	9.13	4-1/4	2-3/4	2-13/64	53123	58083
9,2 mm	0.3622		84,0	40,0	29,0	63024	69027
9,3 mm	0.3661		84,0	40,0	29,0	63082	69028
U	0.3680	9.35	4-1/4	2-3/4	2-13/64	53221	58084
9,4 mm	0.3701		84,0	40,0	29,0	63083	69029
9,5 mm	0.3740		84,0	40,0	29,0	63025	69030
3/8	0.3750	9.53	4-1/4	2-3/4	2-13/64	53124	58085
V	0.3770	9.58	4-1/4	2-3/4	2-13/64	53222	58086
9,6 mm	0.3780		89,0	43,0	31,0	63084	69031
9,7 mm	0.3819		89,0	43,0	31,0	63085	69032
9,8 mm	0.3858		89,0	43,0	31,0	63086	69033
W	0.3860	9.80	4-1/2	2-7/8	2-19/64	53223	58087
9,9 mm	0.3898		89,0	43,0	31,0	63087	69034
25/64	0.3906	9.92	4-1/2	2-7/8	2-19/64	53125	58088
10,0 mm	0.3937		89,0	43,0	31,0	63026	69035
X	0.3970	10.08	4-1/2	2-7/8	2-19/64	53224	58089
10,1 mm	0.3976		89,0	43,0	31,0	63088	69036
10,2 mm	0.4016		89,0	43,0	31,0	63027	69037
Y	0.4040	10.26	4-1/2	2-7/8	2-19/64	53225	58090
13/32	0.4062	10.32	4-1/2	2-7/8	2-19/64	53126	58091
10,4 mm	0.4094		89,0	43,0	31,0	63028	69038
Z	0.4130	10.49	4-1/2	2-7/8	2-19/64	53226	58092
10,5 mm	0.4134		89,0	43,0	31,0	63029	69039
10,7 mm	0.4213		95,0	47,0	33,0	63030	69040
27/64	0.4219	10.72	4-1/2	2-7/8	2-19/64	53127	58093
10,8 mm	0.4252		95,0	47,0	33,0	63031	69041
11,0 mm	0.4331		95,0	47,0	33,0	63032	69042
7/16	0.4375	11.11	4-1/2	2-7/8	2-19/64	53128	58094
11,5 mm	0.4528		95,0	47,0	33,0	63033	69043
29/64	0.4531	11.51	4-3/4	3	2-13/32	53129	58095
15/32	0.4688	11.91	4-3/4	3	2-13/32	53130	58096
12,0 mm	0.4724		102,0	51,0	35,0	63034	69044
31/64	0.4844	12.30	4-3/4	3	2-13/32	53131	58097
12,5 mm	0.4921		102,0	51,0	35,0	63035	69045
1/2	0.5000	12.70	4-3/4	3	2-13/32	53132	58098
12,8 mm	0.5039		102,0	51,0	35,0	63036	69046
13,0 mm	0.5118		102,0	51,0	35,0	63089	69047
33/64	0.5156	13.10	4-3/4	3	2-13/32	53135	58099
13,1 mm	0.5157		102,0	51,0	35,0	63037	69048
13,5 mm	0.5315		107,0	54,0	37,0	63090	69049
14,0 mm	0.5512		107,0	54,0	37,0	63038	69050
9/16	0.5625	14.29	4-3/4	3	2-13/32	53136	58100
14,3 mm	0.5630		111,0	56,0	38,0	63039	69051
14,5 mm	0.5709		111,0	56,0	38,0	63040	69052
15,0 mm	0.5906		111,0	56,0	38,0	63091	69053
5/8	0.6250	15.88	5-3/4	3-1/2	2-51/64	53133	58101
11/16	0.6875	17.46	5-3/4	3-1/2	2-51/64	53137	58102
17,5 mm	0.6890		123,0	62,0	40,0	63041	69054
3/4	0.7500	19.05	5-3/4	4-1/4	3 13/32	53134	58103
19,5 mm	0.7677		131,0	66,0	42,0	63042	69055
20,0 mm	0.7874		131,0	66,0	42,0	63043	69056

3 Flute Drills

Series 103 Fractional	Hardness	Vc (sfm)	Diameter (D ₁) (inch)							
			1/8	1/4	3/8	1/2	5/8	3/4		
P CARBON STEELS 1018, 1040, 1080, 1090, 10L50, 1140, 1212, 12L15, 1525, 1536	≤ 175 Bhn or ≤ 7 HRc	295 (236-354)	RPM	9015	4508	3005	2254	1803	1503	
			Fr	0.0026	0.0051	0.0077	0.0102	0.0128	0.0153	
			Feed (ipm)	23.0	23.0	23.0	23.0	23.0	23.0	
	≤ 300 Bhn or ≤ 32 HRc	260 (208-312)	RPM	7946	3973	2649	1986	1589	1324	
			Fr	0.0023	0.0045	0.0068	0.0091	0.0113	0.0136	
			Feed (ipm)	18.0	18.0	18.0	18.0	18.0	18.0	
	≤ 425 Bhn or ≤ 45 HRc	150 (120-180)	RPM	4584	2292	1528	1146	917	764	
			Fr	0.0013	0.0026	0.0039	0.0052	0.0065	0.0079	
			Feed (ipm)	6.0	6.0	6.0	6.0	6.0	6.0	
	H ALLOY STEELS 4140, 4150, 4320, 5120, 5150, 8630, 86L20, 50100	≤ 275 Bhn or ≤ 28 HRc	230 (184-276)	RPM	7029	3514	2343	1757	1406	1171
				Fr	0.0019	0.0038	0.0058	0.0077	0.0096	0.0115
				Feed (ipm)	13.5	13.5	13.5	13.5	13.5	13.5
≤ 375 Bhn or ≤ 40 HRc		145 (116-174)	RPM	4431	2216	1477	1108	886	739	
			Fr	0.0019	0.0038	0.0058	0.0077	0.0096	0.0115	
			Feed (ipm)	8.5	8.5	8.5	8.5	8.5	8.5	
≤ 450 Bhn or ≤ 48 HRc		115 (92-138)	RPM	3514	1757	1171	879	703	586	
			Fr	0.0005	0.0010	0.0015	0.0020	0.0026	0.0031	
			Feed (ipm)	1.8	1.8	1.8	1.8	1.8	1.8	
K TOOL STEELS A2, D2, H13, L2, M2, P20, S7, T15, W2		≤ 250 Bhn or ≤ 24 HRc	85 (68-102)	RPM	2598	1299	866	649	520	433
				Fr	0.0013	0.0026	0.0039	0.0052	0.0065	0.0079
				Feed (ipm)	3.4	3.4	3.4	3.4	3.4	3.4
	≤ 375 Bhn or ≤ 40 HRc	65 (52-78)	RPM	1986	993	662	497	397	331	
			Fr	0.0007	0.0013	0.0020	0.0026	0.0033	0.0039	
			Feed (ipm)	1.3	1.3	1.3	1.3	1.3	1.3	
	≤ 475 Bhn or ≤ 50 HRc	50 (40-60)	RPM	1528	764	509	382	306	255	
			Fr	0.0007	0.0013	0.0020	0.0026	0.0033	0.0039	
			Feed (ipm)	1.0	1.0	1.0	1.0	1.0	1.0	
	N CAST IRONS Gray, Malleable, Ductile	≤ 220 Bhn or ≤ 19 HRc	250 (200-300)	RPM	7640	3820	2547	1910	1528	1273
				Fr	0.0026	0.0052	0.0079	0.0105	0.0131	0.0157
				Feed (ipm)	20.0	20.0	20.0	20.0	20.0	20.0
≤ 330 Bhn or ≤ 36 HRc		195 (156-234)	RPM	5959	2980	1986	1490	1192	993	
			Fr	0.0026	0.0052	0.0078	0.0104	0.0130	0.0156	
			Feed (ipm)	15.5	15.5	15.5	15.5	15.5	15.5	
N ALUMINUM ALLOYS 2017, 2024, 356, 6061, 7075		≤ 80 Bhn or ≤ 47 HRb	540 (432-648)	RPM	16502	8251	5501	4126	3300	2750
				Fr	0.0032	0.0064	0.0096	0.0128	0.0161	0.0193
				Feed (ipm)	53.0	53.0	53.0	53.0	53.0	53.0
		≤ 150 Bhn or ≤ 7 HRc	455 (364-546)	RPM	13905	6952	4635	3476	2781	2317
				Fr	0.0032	0.0065	0.0097	0.0129	0.0162	0.0194
				Feed (ipm)	45.0	45.0	45.0	45.0	45.0	45.0
	N COPPER ALLOYS Alum Bronze, C110, Muntz Brass	≤ 140 Bhn or ≤ 3 HRc	305 (244-366)	RPM	9321	4660	3107	2330	1864	1553
				Fr	0.0019	0.0039	0.0058	0.0077	0.0097	0.0116
				Feed (ipm)	18.0	18.0	18.0	18.0	18.0	18.0
		≤ 200 Bhn or ≤ 23 HRc	160 (128-192)	RPM	4890	2445	1630	1222	978	815
				Fr	0.0016	0.0033	0.0049	0.0065	0.0082	0.0098
				Feed (ipm)	8.0	8.0	8.0	8.0	8.0	8.0

Bhn (Brinell) HRc (Rockwell C) HRb (Rockwell B)

rpm = Vc x 3.82 / D₁

ipm = Fr x rpm

reduce speed and feed 30 percent when using uncoated drills

reduce speed and feed for materials harder than listed

refer to the KYOCERA SGS Tool Wizard® for complete technical information (www.kyocera-sgstool.com)

3 Flute Drills

Series 103M Metric	Hardness	Vc (m/min)	Diameter (D ₁) (mm)							
			3	6	10	12	16	20		
P	CARBON STEELS 1018, 1040, 1080, 1090, 10L50, 1140, 1212, 12L15, 1525, 1536	≤ 175 Bhn or ≤ 7 HRc	90	RPM	9533	4766	2860	2383	1787	1430
			(72-108)	Fr	0.062	0.124	0.206	0.248	0.330	0.413
				Feed (mm/min)	590	590	590	590	590	590
		≤ 300 Bhn or ≤ 32 HRc	79	RPM	8402	4201	2520	2100	1575	1260
			(63-95)	Fr	0.055	0.110	0.183	0.219	0.292	0.365
				Feed (mm/min)	460	460	460	460	460	460
	≤ 425 Bhn or ≤ 45 HRc	46	RPM	4847	2424	1454	1212	909	727	
		(37-55)	Fr	0.032	0.064	0.107	0.128	0.171	0.213	
			Feed (mm/min)	155	155	155	155	155	155	
	ALLOY STEELS 4140, 4150, 4320, 5120, 5150, 8630, 86L20, 50100	≤ 275 Bhn or ≤ 28 HRc	70	RPM	7432	3716	2230	1858	1394	1115
			(56-84)	Fr	0.046	0.093	0.155	0.186	0.248	0.309
				Feed (mm/min)	345	345	345	345	345	345
≤ 375 Bhn or ≤ 40 HRc		44	RPM	4686	2343	1406	1171	879	703	
		(35-53)	Fr	0.046	0.092	0.153	0.184	0.245	0.306	
			Feed (mm/min)	215	215	215	215	215	215	
≤ 450 Bhn or ≤ 48 HRc	35	RPM	3716	1858	1115	929	697	557		
	(28-42)	Fr	0.012	0.024	0.040	0.048	0.065	0.081		
		Feed (mm/min)	45	45	45	45	45	45		
H	TOOL STEELS A2, D2, H13, L2, M2, P20, S7, T15, W2	≤ 250 Bhn or ≤ 24 HRc	26	RPM	2747	1373	824	687	515	412
			(21-31)	Fr	0.031	0.062	0.103	0.124	0.165	0.206
				Feed (mm/min)	85	85	85	85	85	85
		≤ 375 Bhn or ≤ 40 HRc	20	RPM	2100	1050	630	525	394	315
			(16-24)	Fr	0.017	0.033	0.056	0.067	0.089	0.111
				Feed (mm/min)	35	35	35	35	35	35
≤ 475 Bhn or ≤ 50 HRc	15	RPM	1616	808	485	404	303	242		
	(12-18)	Fr	0.015	0.031	0.052	0.062	0.083	0.103		
		Feed (mm/min)	25	25	25	25	25	25		
K	CAST IRONS Gray, Malleable, Ductile	≤ 220 Bhn or ≤ 19 HRc	76	RPM	8078	4039	2424	2020	1515	1212
			(61-91)	Fr	0.063	0.126	0.210	0.253	0.337	0.421
				Feed (mm/min)	510	510	510	510	510	510
		≤ 330 Bhn or ≤ 36 HRc	59	RPM	6301	3151	1890	1575	1181	945
			(48-71)	Fr	0.052	0.105	0.175	0.209	0.279	0.349
				Feed (mm/min)	330	330	330	330	330	330
N	ALUMINUM ALLOYS 2017, 2024, 356, 6061, 7075	≤ 80 Bhn or ≤ 47 HRb	165	RPM	17449	8725	5235	4362	3272	2617
			(132-198)	Fr	0.078	0.156	0.260	0.312	0.416	0.520
				Feed (mm/min)	1360	1360	1360	1360	1360	1360
		≤ 150 Bhn or ≤ 7 HRc	139	RPM	14703	7351	4411	3676	2757	2205
			(111-166)	Fr	0.078	0.156	0.261	0.313	0.417	0.521
				Feed (mm/min)	1150	1150	1150	1150	1150	1150
COPPER ALLOYS Alum Bronze, C110, Muntz Brass	≤ 140 Bhn or ≤ 3 HRc	93	RPM	9856	4928	2957	2464	1848	1478	
		(74-112)	Fr	0.047	0.094	0.157	0.189	0.252	0.315	
			Feed (mm/min)	465	465	465	465	465	465	
≤ 200 Bhn or ≤ 23 HRc	49	RPM	5170	2585	1551	1293	969	776		
	(39-59)	Fr	0.039	0.077	0.129	0.155	0.206	0.258		
		Feed (mm/min)	200	200	200	200	200	200		

Bhn (Brinell) HRc (Rockwell C) HRb (Rockwell B)
 rpm = (Vc x 1000) / (D₁ x 3.14)
 mm/min = Fr x rpm
 reduce speed and feed 30 percent when using uncoated drills
 reduce speed and feed for materials harder than listed
 refer to the KYOCERA SGS Tool Wizard® for complete technical information (www.kyocera-sgstool.com)

Combined Drill & Countersink



301 FRACTIONAL SERIES

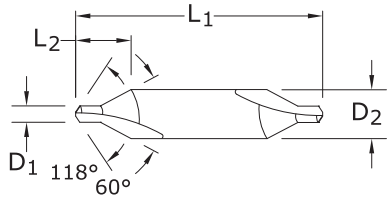

*Pictured:
Series 301 Set*

SIZE	inch				EDP NO.	
	DRILL DIAMETER D ₁	BODY DIAMETER D ₂	OVERALL LENGTH L ₁	FLUTE LENGTH L ₂	UNCOATED	Ti-NAMITE-A (AlTiN)
00*	.025	1/8	1-1/2	.125	57005	57015
0*	1/32	1/8	1-1/2	.130	57006	57016
1*	3/64	1/8	1-1/2	.135	57007	57017
2*	5/64	3/16	1-7/8	.200	57008	57018
3*	7/64	1/4	2	.280	57009	57019
4*	1/8	5/16	2-1/8	.340	57010	57020
5*	3/16	7/16	2-3/4	.475	57011	57021
6*	7/32	1/2	3	.540	57012	57022
*Series 301 Set	—	—	—	—	57075	—

TOLERANCES (inch)

D₁ = +.003/-.000
D₂ = -.0001/-.0005

- STEELS
- STAINLESS STEELS
- CAST IRON
- HIGH TEMP ALLOYS
- TITANIUM
- HARDENED STEELS
- NON-FERROUS
- PLASTICS/COMPOSITES

For patent information visit www.ksptpatents.com

Combined Drill & Countersink

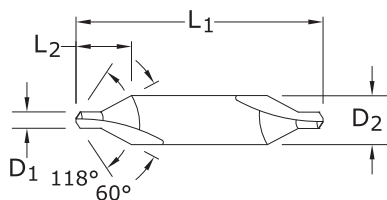

TOLERANCES (mm)

$D_1 = +0,076/-0,000$
 $D_2 = -0,0025/-0,0127$

- STEELS
- STAINLESS STEELS
- CAST IRON
- HIGH TEMP ALLOYS
- TITANIUM
- HARDENED STEELS
- NON-FERROUS
- PLASTICS/COMPOSITES

For patent information visit www.ksptpatents.com

301M
METRIC SERIES

mm				EDP NO.	
DRILL DIAMETER D_1	BODY DIAMETER D_2	OVERALL LENGTH L_1	FLUTE LENGTH L_2	UNCOATED	Ti-NAMITE-A (AITiN)
0,5	3,15	20,0	3,0	67005	67035
0,8	3,15	20,0	3,5	67007	67037
1	3,15	31,5	3,5	67009	67039
1,25	3,15	31,5	4,0	67011	67041
1,6	4,0	35,5	5,0	67013	67043
2	5,0	40,0	6,0	67015	67045
2,5	6,3	45,0	7,0	67017	67047
3,15	8,0	50,0	9,0	67019	67049
4	10,0	56,0	11,0	67021	67051
5	12,5	63,0	14,0	67023	67053

Combined Drill & Countersink

Series 301 Fractional	Hardness	Vc (sfm)	Diameter (D ₁) (inch)						
			1/32	5/64	1/8	3/16	7/32		
P CARBON STEELS 1018, 1040, 1080, 1090, 10L50, 1140, 1212, 12L15, 1525, 1536	≤ 175 Bhn or ≤ 7 HRc	265	RPM	8098	5399	3239	2314	2025	
		(212-318)	Fr	0.00068	0.0010	0.0017	0.0024	0.0027	
			Feed (ipm)	5.5	5.5	5.5	5.5	5.5	
	≤ 300 Bhn or ≤ 32 HRc	125	RPM	3820	2547	1528	1091	955	
		(100-150)	Fr	0.00065	0.0010	0.0016	0.0023	0.0026	
			Feed (ipm)	2.5	2.5	2.5	2.5	2.5	
	≤ 425 Bhn or ≤ 45 HRc	85	RPM	2598	1732	1039	742	649	
		(68-102)	Fr	0.00038	0.0006	0.0010	0.0013	0.0015	
			Feed (ipm)	1.0	1.0	1.0	1.0	1.0	
	P ALLOY STEELS 4140, 4150, 4320, 5120, 5150, 8630, 86L20, 50100	≤ 275 Bhn or ≤ 28 HRc	230	RPM	7029	4686	2812	2008	1757
			(184-276)	Fr	0.00064	0.0010	0.0016	0.0022	0.0026
				Feed (ipm)	4.5	4.5	4.5	4.5	4.5
≤ 375 Bhn or ≤ 40 HRc		145	RPM	4431	2954	1772	1266	1108	
		(116-174)	Fr	0.00059	0.0009	0.0015	0.0021	0.0023	
			Feed (ipm)	2.6	2.6	2.6	2.6	2.6	
≤ 450 Bhn or ≤ 48 HRc		60	RPM	1834	1222	733	524	458	
		(48-72)	Fr	0.00027	0.0004	0.0007	0.0010	0.0011	
			Feed (ipm)	0.5	0.5	0.5	0.5	0.5	
H TOOL STEELS A2, D2, H13, L2, M2, P20, S7, T15, W2		≤ 250 Bhn or ≤ 24 HRc	85	RPM	2598	1732	1039	742	649
			(68-102)	Fr	0.00035	0.0005	0.0009	0.0012	0.0014
				Feed (ipm)	0.9	0.9	0.9	0.9	0.9
	≤ 375 Bhn or ≤ 40 HRc	55	RPM	1681	1121	672	480	420	
		(44-66)	Fr	0.00016	0.0002	0.0004	0.0006	0.0006	
			Feed (ipm)	0.3	0.3	0.3	0.3	0.3	
	≤ 475 Bhn or ≤ 50 HRc	40	RPM	1222	815	489	349	306	
		(32-48)	Fr	0.00016	0.0002	0.0004	0.0006	0.0007	
			Feed (ipm)	0.2	0.2	0.2	0.2	0.2	
	K CAST IRONS Gray, Malleable, Ductile	≤ 220 Bhn or ≤ 19 HRc	280	RPM	8557	5705	3423	2445	2139
			(224-336)	Fr	0.00084	0.0013	0.0021	0.0029	0.0034
				Feed (ipm)	7.2	7.2	7.2	7.2	7.2
≤ 330 Bhn or ≤ 36 HRc		250	RPM	7640	5093	3056	2183	1910	
		(200-300)	Fr	0.00084	0.0013	0.0021	0.0029	0.0034	
			Feed (ipm)	6.4	6.4	6.4	6.4	6.4	
M STAINLESS STEELS (FREE MACHINING) 303, 416, 420F, 430F 440F	≤ 250 Bhn or ≤ 24 HRc0	210	RPM	6418	4278	2567	1834	1604	
		(168-252)	Fr	0.00048	0.0007	0.0012	0.0017	0.0019	
			Feed (ipm)	3.1	3.1	3.1	3.1	3.1	
	≤ 330 Bhn or ≤ 36 HRc	110	RPM	3362	2241	1345	960	840	
		(88-132)	Fr	0.00028	0.0004	0.0007	0.0010	0.0011	
			Feed (ipm)	0.9	0.9	0.9	0.9	0.9	
	M STAINLESS STEELS (DIFFICULT) 304, 316, 321, 13-8 PH, 15-5PH, 17-4 PH, Custom 450	≤ 275 Bhn or ≤ 28 HRc	65	RPM	1986	1324	795	568	497
			(52-78)	Fr	0.00036	0.0005	0.0009	0.0013	0.0014
				Feed (ipm)	0.7	0.7	0.7	0.7	0.7
		≤ 375 Bhn or ≤ 40 HRc	55	RPM	1681	1121	672	480	420
			(44-66)	Fr	0.00032	0.0005	0.0008	0.0011	0.0013
				Feed (ipm)	0.5	0.5	0.5	0.5	0.5

continued on next page

Combined Drill & Countersink

Series 301 Fractional	Hardness	Vc (sfm)	Diameter (D ₁) (inch)						
			1/32	5/64	1/8	3/16	7/32		
S SUPER ALLOYS (NICKEL, COBALT, IRON BASE) Inconel 601, 617, 625, Incoloy 800, Monel 400, Rene, Waspaloy	≤ 220 Bhn or ≤ 19 HRc	40 (32-48)	RPM	1222	815	489	349	306	
			Fr	0.00036	0.0005	0.0009	0.0013	0.0014	
			Feed (ipm)	0.4	0.4	0.4	0.4	0.4	
	≤ 320 Bhn or ≤ 34 HRc	25 (20-30)	RPM	764	509	306	218	191	
			Fr	0.00033	0.0005	0.0008	0.0011	0.0013	
			Feed (ipm)	0.3	0.3	0.3	0.3	0.3	
	≤ 425 Bhn or ≤ 45 HRc	20 (16-24)	RPM	611	407	244	175	153	
			Fr	0.00016	0.0002	0.0004	0.0006	0.0007	
			Feed (ipm)	0.1	0.1	0.1	0.1	0.1	
	TITANIUM ALLOYS Pure Titanium, Ti6Al4V, Ti6Al2Sn4Zr2Mo, Ti4Al4Mo2Sn0.5Si, Ti-6Al4V	≤ 275 Bhn or ≤ 28 HRc	85 (68-102)	RPM	2598	1732	1039	742	649
				Fr	0.00064	0.0010	0.0016	0.0022	0.0026
				Feed (ipm)	1.7	1.7	1.7	1.7	1.7
≤ 350 Bhn or ≤ 38 HRc		65 (52-78)	RPM	1986	1324	795	568	497	
			Fr	0.00036	0.0005	0.0009	0.0013	0.0014	
			Feed (ipm)	0.7	0.7	0.7	0.7	0.7	
≤ 440 Bhn or ≤ 47 HRc		55 (44-66)	RPM	1681	1121	672	480	420	
			Fr	0.00032	0.0005	0.0008	0.0011	0.0013	
			Feed (ipm)	0.5	0.5	0.5	0.5	0.5	
N ALUMINUM ALLOYS 2017, 2024, 356, 6061, 7075		≤ 80 Bhn or ≤ 47 HRb	540 (432-648)	RPM	16502	11002	6601	4715	4126
				Fr	0.00100	0.0015	0.0025	0.0035	0.0040
				Feed (ipm)	16.5	16.5	16.5	16.5	16.5
	≤ 150 Bhn or ≤ 7 HRc	455 (364-546)	RPM	13905	9270	5562	3973	3476	
			Fr	0.00100	0.0015	0.0025	0.0035	0.0040	
			Feed (ipm)	13.9	13.9	13.9	13.9	13.9	
	≤ 140 Bhn or ≤ 3 HRc	190 (152-228)	RPM	5806	3871	2323	1659	1452	
			Fr	0.00048	0.0007	0.0012	0.0017	0.0019	
			Feed (ipm)	2.8	2.8	2.8	2.8	2.8	
	≤ 200 Bhn or ≤ 23 HRc	175 (140-210)	RPM	5348	3565	2139	1528	1337	
			Fr	0.00048	0.0007	0.0012	0.0017	0.0019	
			Feed (ipm)	2.6	2.6	2.6	2.6	2.6	
PLASTICS Polycarbonate, PVC	500 (400-600)	RPM	15280	10187	6112	4366	3820		
		Fr	0.00100	0.0015	0.0025	0.0035	0.0040		
		Feed (ipm)	15.3	15.3	15.3	15.3	15.3		

Bhn (Brinell) HRc (Rockwell C) HRb (Rockwell B)

$rpm = Vc \times 3.82 / D_1$

$ipm = Fr \times rpm$

reduce speed and feed 30 percent when using uncoated drills

reduce speed and feed for materials harder than listed

refer to the KYOCERA SGS Tool Wizard® for complete technical information (www.kyocera-sgstool.com)

Combined Drill & Countersink

Series 301M Metric	Hardness	Vc (m/min)	Diameter (D ₁) (mm)						
			1	1.6	2.5	4	5		
P CARBON STEELS 1018, 1040, 1080, 1090, 10L50, 1140, 1212, 12L15, 1525, 1536	≤ 175 Bhn or ≤ 7 HRc	81	RPM	8155	6422	4078	2569	2055	
		(65-97)	Fr	0.017	0.022	0.034	0.054	0.068	
			Feed (mm/min)	139	139	139	139	139	
	≤ 300 Bhn or ≤ 32 HRc	38	RPM	3847	3029	1923	1212	969	
		(30-46)	Fr	0.016	0.020	0.032	0.051	0.064	
			Feed (mm/min)	62	62	62	62	62	
	≤ 425 Bhn or ≤ 45 HRc	26	RPM	2616	2060	1308	824	659	
		(21-31)	Fr	0.010	0.013	0.020	0.032	0.039	
			Feed (mm/min)	26	26	26	26	26	
	P ALLOY STEELS 4140, 4150, 4320, 5120, 5150, 8630, 86L20, 50100	≤ 275 Bhn or ≤ 28 HRc	70	RPM	7078	5574	3539	2230	1784
			(56-84)	Fr	0.016	0.020	0.032	0.051	0.063
				Feed (mm/min)	113	113	113	113	113
≤ 375 Bhn or ≤ 40 HRc		44	RPM	4462	3514	2231	1406	1125	
		(35-53)	Fr	0.015	0.019	0.030	0.048	0.060	
			Feed (mm/min)	67	67	67	67	67	
≤ 450 Bhn or ≤ 48 HRc		18	RPM	1847	1454	923	582	465	
		(15-22)	Fr	0.007	0.009	0.014	0.022	0.028	
			Feed (mm/min)	13	13	13	13	13	
H TOOL STEELS A2, D2, H13, L2, M2, P20, S7, T15, W2		≤ 250 Bhn or ≤ 24 HRc	26	RPM	2616	2060	1308	824	659
			(21-31)	Fr	0.009	0.012	0.018	0.029	0.036
				Feed (mm/min)	24	24	24	24	24
	≤ 375 Bhn or ≤ 40 HRc	17	RPM	1693	1333	846	533	427	
		(13-20)	Fr	0.004	0.005	0.008	0.013	0.016	
			Feed (mm/min)	7	7	7	7	7	
	≤ 475 Bhn or ≤ 50 HRc	12	RPM	1231	969	616	388	310	
		(10-15)	Fr	0.004	0.005	0.008	0.013	0.016	
			Feed (mm/min)	5	5	5	5	5	
	K CAST IRONS Gray, Malleable, Ductile	≤ 220 Bhn or ≤ 19 HRc	85	RPM	8617	6786	4309	2714	2171
			(68-102)	Fr	0.021	0.027	0.042	0.067	0.083
				Feed (mm/min)	181	181	181	181	181
≤ 330 Bhn or ≤ 36 HRc		76	RPM	7694	6059	3847	2424	1939	
		(61-91)	Fr	0.021	0.027	0.042	0.067	0.084	
			Feed (mm/min)	162	162	162	162	162	
M STAINLESS STEELS (FREE MACHINING) 303, 416, 420F, 430F 440F	≤ 250 Bhn or ≤ 24 HRc	64	RPM	6463	5089	3231	2036	1629	
		(51-77)	Fr	0.012	0.015	0.024	0.038	0.048	
			Feed (mm/min)	78	78	78	78	78	
	≤ 330 Bhn or ≤ 36 HRc	34	RPM	3385	2666	1693	1066	853	
		(27-40)	Fr	0.007	0.009	0.014	0.023	0.028	
			Feed (mm/min)	24	24	24	24	24	
	M STAINLESS STEELS (DIFFICULT) 304, 316, 321, 13-8 PH, 15-5PH, 17-4 PH, Custom 450	≤ 275 Bhn or ≤ 28 HRc	20	RPM	2000	1575	1000	630	504
			(16-24)	Fr	0.009	0.011	0.018	0.029	0.036
				Feed (mm/min)	18	18	18	18	18
		≤ 375 Bhn or ≤ 40 HRc	17	RPM	1693	1333	846	533	427
			(13-20)	Fr	0.008	0.011	0.017	0.026	0.033
				Feed (mm/min)	14	14	14	14	14

continued on next page

Combined Drill & Countersink

Series 301M Metric	Hardness	Vc (m/min)	Diameter (D ₁) (mm)						
			1	1.6	2.5	4	5		
SUPER ALLOYS (NICKEL, COBALT, IRON BASE) Inconel 601, 617, 625, Incoloy 800, Monel 400, Rene, Waspaloy	≤ 220 Bhn or ≤ 19 HRc	12 (10-15)	RPM	1231	969	616	388	310	
			Fr	0.009	0.011	0.018	0.028	0.035	
			Feed (mm/min)	11	11	11	11	11	
	≤ 320 Bhn or ≤ 34 HRc	8 (6-9)	RPM	769	606	385	242	194	
			Fr	0.008	0.010	0.016	0.025	0.031	
			Feed (mm/min)	6	6	6	6	6	
	≤ 425 Bhn or ≤ 45 HRc	6 (5-7)	RPM	616	485	308	194	155	
			Fr	0.003	0.004	0.006	0.010	0.013	
			Feed (mm/min)	2	2	2	2	2	
	TITANIUM ALLOYS Pure Titanium, Ti6Al4V, Ti6Al2Sn4Zr2Mo, Ti4Al4Mo2Sn0.5Si, Ti-6Al4V	≤ 275 Bhn or ≤ 28 HRc	26 (21-31)	RPM	2616	2060	1308	824	659
				Fr	0.016	0.020	0.032	0.051	0.064
				Feed (mm/min)	42	42	42	42	42
≤ 350 Bhn or ≤ 38 HRc		20 (16-24)	RPM	2000	1575	1000	630	504	
			Fr	0.009	0.011	0.018	0.029	0.036	
			Feed (mm/min)	18	18	18	18	18	
≤ 440 Bhn or ≤ 47 HRc		17 (13-20)	RPM	1693	1333	846	533	427	
			Fr	0.008	0.011	0.017	0.026	0.033	
			Feed (mm/min)	14	14	14	14	14	
ALUMINUM ALLOYS 2017, 2024, 356, 6061, 7075		≤ 80 Bhn or ≤ 47 HRb	165 (132-198)	RPM	16619	13087	8309	5235	4188
				Fr	0.025	0.032	0.050	0.079	0.099
				Feed (mm/min)	415	415	415	415	415
	≤ 150 Bhn or ≤ 7 HRc	139 (111-166)	RPM	14003	11027	7001	4411	3529	
			Fr	0.025	0.032	0.050	0.079	0.099	
			Feed (mm/min)	350	350	350	350	350	
COPPER ALLOYS Alum Bronze, C110, Muntz Brass	≤ 140 Bhn or ≤ 3 HRc	58 (46-69)	RPM	5847	4605	2924	1842	1474	
			Fr	0.012	0.015	0.024	0.038	0.048	
			Feed (mm/min)	70	70	70	70	70	
	≤ 200 Bhn or ≤ 23 HRc	53 (43-64)	RPM	5386	4241	2693	1696	1357	
			Fr	0.012	0.015	0.024	0.038	0.048	
			Feed (mm/min)	65	65	65	65	65	
PLASTICS Polycarbonate, PVC	152 (122-183)	RPM	15388	12118	7694	4847	3878		
		Fr	0.025	0.032	0.050	0.079	0.099		
			Feed (mm/min)	385	385	385	385	385	

Bhn (Brinell) HRc (Rockwell C) HRb (Rockwell B)
 $rpm = (Vc \times 1000) / (D_1 \times 3.14)$
 $mm/min = Fr \times rpm$
 reduce speed and feed 30 percent when using uncoated drills
 reduce speed and feed for materials harder than listed
 refer to the KYOCERA SGS Tool Wizard® for complete technical information (www.kyocera-sgstool.com)

Single Flute Countersink

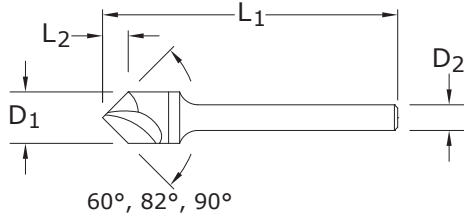

601

FRACTIONAL SERIES

CUTTING DIAMETER D ₁	SHANK DIAMETER D ₂	inch		EDP NO.		
		OVERALL LENGTH L ₁	FLUTE LENGTH L ₂	UNCOATED 60°	UNCOATED 82°	UNCOATED 90°
1/8	1/8	1-1/2	.062	—	—	74201
1/8	1/8	1-1/2	.072	—	74101	—
1/8	1/8	1-1/2	.108	74001	—	—
3/16	3/16	2	.094	—	—	74204
3/16	3/16	2	.108	—	74104	—
3/16	3/16	2	.163	74004	—	—
1/4	1/4	2	.125	—	—	74207
1/4	1/4	2	.144	—	74107	—
1/4	1/4	2	.217	74007	—	—
3/8*	1/4	2-13/16	.188	—	—	74210
3/8*	1/4	2-13/16	.216	—	74110	—
3/8*	1/4	2-13/16	.325	74010	—	—
1/2*	1/4	2-7/8	.250	—	—	74213
1/2*	1/4	2-7/8	.288	—	74113	—
1/2*	1/4	2-7/8	.433	74013	—	—
5/8*	3/8	3	.313	—	—	74216
5/8*	3/8	3	.360	—	74116	—
5/8*	3/8	3	.541	74016	—	—
3/4*	1/2	3	.375	—	—	74219
3/4*	1/2	3	.431	—	74119	—
3/4*	1/2	3	.650	74019	—	—
1*	1/2	3-1/4	.500	—	—	74222
1*	1/2	3-1/4	.575	—	74122	—
1*	1/2	3-1/4	.866	74022	—	—

*Steel Shank / Con mango de acero / Avec queue en acier / Mit Stahlschaft

TOLERANCES (inch)

1/8–1/4 DIAMETER

D₁ = +.0000/–.0005

3/8–1 DIAMETER

D₁ = +.003/–.000

Included Angle

+1°/–1°

- STEELS
- STAINLESS STEELS
- CAST IRON
- HIGH TEMP ALLOYS
- TITANIUM
- HARDENED STEELS
- NON-FERROUS

For patent information visit www.ksptpatents.com

Single Flute Countersink

Series 601 Fractional	Hardness	Vc (sfm)	Diameter (D1) (inch)								
			1/8	3/16	1/4	3/8	1/2	3/4	1		
P CARBON STEELS 1018, 1040, 1080, 1090, 10L50, 1140, 1212, 12L15, 1525, 1536	≤ 175 Bhn or ≤ 7 HRc	125 (100-150)	RPM	3820	2547	1910	1273	955	637	478	
			Fr	0.0005	0.0008	0.0010	0.0016	0.0021	0.0031	0.0042	
			Feed (ipm)	2.0	2.0	2.0	2.0	2.0	2.0	2.0	
	≤ 300 Bhn or ≤ 32 HRc	60 (48-72)	RPM	1834	1222	917	611	458	306	229	
			Fr	0.0005	0.0007	0.0010	0.0015	0.0020	0.0029	0.0039	
			Feed (ipm)	0.9	0.9	0.9	0.9	0.9	0.9	0.9	
	≤ 425 Bhn or ≤ 45 HRc	45 (36-54)	RPM	1375	917	688	458	344	229	172	
			Fr	0.0003	0.0004	0.0006	0.0009	0.0012	0.0017	0.0023	
			Feed (ipm)	0.4	0.4	0.4	0.4	0.4	0.4	0.4	
	H ALLOY STEELS 4140, 4150, 4320, 5120, 5150, 8630, 86L20, 50100	≤ 275 Bhn or ≤ 28 HRc	95 (76-114)	RPM	2903	1935	1452	968	726	484	363
				Fr	0.0004	0.0007	0.0009	0.0013	0.0018	0.0027	0.0036
				Feed (ipm)	1.3	1.3	1.3	1.3	1.3	1.3	1.3
≤ 375 Bhn or ≤ 40 HRc		60 (48-72)	RPM	1834	1222	917	611	458	306	229	
			Fr	0.0004	0.0007	0.0009	0.0013	0.0017	0.0026	0.0035	
			Feed (ipm)	0.8	0.8	0.8	0.8	0.8	0.8	0.8	
≤ 450 Bhn or ≤ 48 HRc		35 (28-42)	RPM	1070	713	535	357	267	178	134	
			Fr	0.0003	0.0004	0.0006	0.0008	0.0011	0.0017	0.0022	
			Feed (ipm)	0.3	0.3	0.3	0.3	0.3	0.3	0.3	
K TOOL STEELS A2, D2, H13, L2, M2, P20, S7, T15, W2		≤ 250 Bhn or ≤ 24 HRc	35 (28-42)	RPM	1070	713	535	357	267	178	134
				Fr	0.0003	0.0004	0.0006	0.0008	0.0011	0.0017	0.0022
				Feed (ipm)	0.3	0.3	0.3	0.3	0.3	0.3	0.3
	≤ 375 Bhn or ≤ 40 HRc	25 (20-30)	RPM	764	509	382	255	191	127	96	
			Fr	0.0001	0.0002	0.0003	0.0004	0.0005	0.0008	0.0010	
			Feed (ipm)	0.1	0.1	0.1	0.1	0.1	0.1	0.1	
	≤ 475 Bhn or ≤ 50 HRc	20 (16-24)	RPM	611	407	306	204	153	102	76	
			Fr	0.0002	0.0002	0.0003	0.0005	0.0007	0.0010	0.0013	
			Feed (ipm)	0.1	0.1	0.1	0.1	0.1	0.1	0.1	
	M CAST IRONS Gray, Malleable, Ductile	≤ 220 Bhn or ≤ 19 HRc	105 (84-126)	RPM	3209	2139	1604	1070	802	535	401
				Fr	0.0006	0.0009	0.0012	0.0018	0.0024	0.0036	0.0047
				Feed (ipm)	1.9	1.9	1.9	1.9	1.9	1.9	1.9
≤ 330 Bhn or ≤ 36 HRc		75 (60-90)	RPM	2292	1528	1146	764	573	382	287	
			Fr	0.0006	0.0009	0.0012	0.0018	0.0024	0.0037	0.0049	
			Feed (ipm)	1.4	1.4	1.4	1.4	1.4	1.4	1.4	
M STAINLESS STEELS (FREE MACHINING) 303, 416, 420F, 430F 440F		≤ 250 Bhn or ≤ 24 HRc	53 (42-64)	RPM	1620	1080	810	540	405	270	202
				Fr	0.0003	0.0005	0.0006	0.0009	0.0012	0.0019	0.0025
				Feed (ipm)	0.5	0.5	0.5	0.5	0.5	0.5	0.5
		≤ 330 Bhn or ≤ 36 HRc	46 (37-55)	RPM	1406	937	703	469	351	234	176
				Fr	0.0002	0.0003	0.0004	0.0006	0.0009	0.0013	0.0017
				Feed (ipm)	0.3	0.3	0.3	0.3	0.3	0.3	0.3
	M STAINLESS STEELS (DIFFICULT) 304, 316, 321, 13-8 PH, 15-5PH, 17-4 PH, Custom 450	≤ 275 Bhn or ≤ 28 HRc	28 (22-34)	RPM	856	570	428	285	214	143	107
				Fr	0.0004	0.0005	0.0007	0.0011	0.0014	0.0021	0.0028
				Feed (ipm)	0.3	0.3	0.3	0.3	0.3	0.3	0.3
		≤ 375 Bhn or ≤ 40 HRc	21 (17-25)	RPM	642	428	321	214	160	107	80
				Fr	0.0002	0.0002	0.0003	0.0005	0.0006	0.0009	0.0012
				Feed (ipm)	0.1	0.1	0.1	0.1	0.1	0.1	0.1

continued on next page

Single Flute Countersink

Series 601 Fractional	Hardness	Vc (sfm)	Diameter (D ₁) (inch)								
			1/8	3/16	1/4	3/8	1/2	3/4	1		
SUPER ALLOYS (NICKEL, COBALT, IRON BASE) Inconel 601, 617, 625, Incoloy 800, Monel 400, Rene, Waspaloy	≤ 220 Bhn or ≤ 19 HRc	18 (14-22)	RPM	550	367	275	183	138	92	69	
			Fr	0.0002	0.0003	0.0004	0.0005	0.0007	0.0011	0.0015	
			Feed (ipm)	0.1	0.1	0.1	0.1	0.1	0.1	0.1	
	≤ 320 Bhn or ≤ 34 HRc	14 (11-17)	RPM	428	285	214	143	107	71	53	
			Fr	0.0002	0.0004	0.0005	0.0007	0.0009	0.0014	0.0019	
			Feed (ipm)	0.1	0.1	0.1	0.1	0.1	0.1	0.1	
	≤ 425 Bhn or ≤ 45 HRc	12 (10-14)	RPM	367	244	183	122	92	61	46	
			Fr	0.0003	0.0004	0.0005	0.0008	0.0011	0.0016	0.0022	
			Feed (ipm)	0.1	0.1	0.1	0.1	0.1	0.1	0.1	
	TITANIUM ALLOYS Pure Titanium, Ti6Al4V, Ti6Al2Sn4Zr2Mo, Ti4Al4Mo2Sn0.5Si, Ti-6Al4V	≤ 275 Bhn or ≤ 28 HRc	36 (29-43)	RPM	1100	733	550	367	275	183	138
				Fr	0.0005	0.0007	0.0009	0.0014	0.0018	0.0027	0.0036
				Feed (ipm)	0.5	0.5	0.5	0.5	0.5	0.5	0.5
≤ 350 Bhn or ≤ 38 HRc		28 (22-34)	RPM	856	570	428	285	214	143	107	
			Fr	0.0004	0.0005	0.0007	0.0011	0.0014	0.0021	0.0028	
			Feed (ipm)	0.3	0.3	0.3	0.3	0.3	0.3	0.3	
≤ 440 Bhn or ≤ 47 HRc		21 (17-25)	RPM	642	428	321	214	160	107	80	
			Fr	0.0002	0.0002	0.0003	0.0005	0.0006	0.0009	0.0012	
			Feed (ipm)	0.1	0.1	0.1	0.1	0.1	0.1	0.1	
ALUMINUM ALLOYS 2017, 2024, 356, 6061, 7075		≤ 80 Bhn or ≤ 47 HRb	225 (180-270)	RPM	6876	4584	3438	2292	1719	1146	860
				Fr	0.0008	0.0011	0.0015	0.0023	0.0030	0.0045	0.0061
				Feed (ipm)	5.2	5.2	5.2	5.2	5.2	5.2	5.2
	≤ 150 Bhn or ≤ 7 HRc	190 (152-228)	RPM	5806	3871	2903	1935	1452	968	726	
			Fr	0.0008	0.0011	0.0015	0.0023	0.0030	0.0045	0.0061	
			Feed (ipm)	4.4	4.4	4.4	4.4	4.4	4.4	4.4	
	COPPER ALLOYS Alum Bronze, C110, Muntz Brass	≤ 140 Bhn or ≤ 3 HRc	95 (76-114)	RPM	2903	1935	1452	968	726	484	363
				Fr	0.0004	0.0006	0.0008	0.0011	0.0015	0.0023	0.0030
				Feed (ipm)	1.1	1.1	1.1	1.1	1.1	1.1	1.1
		≤ 200 Bhn or ≤ 23 HRc	80 (64-96)	RPM	2445	1630	1222	815	611	407	306
				Fr	0.0004	0.0006	0.0008	0.0012	0.0016	0.0025	0.0033
				Feed (ipm)	1.0	1.0	1.0	1.0	1.0	1.0	1.0

Bhn (Brinell) HRc (Rockwell C) HRb (Rockwell B)

rpm = Vc x 3.82 / D₁

ipm = Fr x rpm

reduce speed and feed for materials harder than listed

refer to the KYOCERA SGS Tool Wizard® for complete technical information (www.kyocera-sgstool.com)

3 Flute Countersink

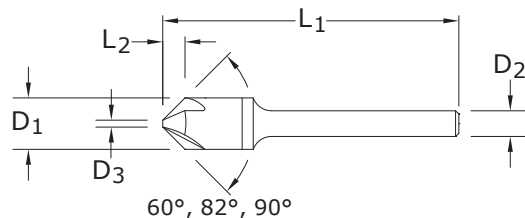

603
FRACTIONAL SERIES

TOLERANCES (inch)

1/8–1/4 DIAMETER

D₁ = +.0000/–.0005

3/8–1 DIAMETER

D₁ = +.003/–.000

Included Angle

+1°/–1°

STEELS

STAINLESS STEELS

CAST IRON

HIGH TEMP ALLOYS

TITANIUM

HARDENED STEELS

NON-FERROUS

For patent information visit www.ksptpatents.com

inch				EDP NO.		
CUTTING DIAMETER D ₁	SHANK DIAMETER D ₂	OVERALL LENGTH L ₁	TIP DIAMETER D ₃	UNCOATED 60°	UNCOATED 82°	UNCOATED 90°
1/8	1/8	1-1/2	.040	–	–	74225
1/8	1/8	1-1/2	.040	–	74125	–
1/8	1/8	1-1/2	.035	74025	–	–
3/16	3/16	2	.060	–	–	74228
3/16	3/16	2	.060	–	74128	–
3/16	3/16	2	.045	74028	–	–
1/4	1/4	2	.100	–	–	74231
1/4	1/4	2	.100	–	74131	–
1/4	1/4	2	.070	74031	–	–
3/8*	1/4	2-13/16	.108	–	–	74234
3/8*	1/4	2-13/16	.108	–	74134	–
3/8*	1/4	2-13/16	.100	74034	–	–
1/2*	1/4	2-7/8	.122	–	–	74237
1/2*	1/4	2-7/8	.122	–	74137	–
1/2*	1/4	2-7/8	.113	74037	–	–
5/8*	3/8	3	.138	–	–	74240
5/8*	3/8	3	.138	–	74140	–
5/8*	3/8	3	.128	74040	–	–
3/4*	1/2	3	.153	–	–	74243
3/4*	1/2	3	.153	–	74143	–
3/4*	1/2	3	.143	74043	–	–
1*	1/2	3-1/4	.168	–	–	74246
1*	1/2	3-1/4	.168	–	74146	–
1*	1/2	3-1/4	.158	74046	–	–

*Steel Shank / Con mango de acero / Avec queue en acier / Mit Stahlschaft
NOTE: D₃ dimension varies based on angle. Contact your KSPT representative or consult KYOCERA SGS Tool Wizard® for dimension information.

3 Flute Countersink

Series 603 Fractional	Hardness	Vc (sfm)	Diameter (D ₁) (inch)								
			1/8	3/16	1/4	3/8	1/2	3/4	1		
P CARBON STEELS 1018, 1040, 1080, 1090, 10L50, 1140, 1212, 12L15, 1525, 1536	≤ 175 Bhn or ≤ 7 HRc	125	RPM	3820	2547	1910	1273	955	637	478	
		(100-150)	Fr	0.0008	0.0012	0.0016	0.0024	0.0031	0.0047	0.0063	
			Feed (ipm)	3.0	3.0	3.0	3.0	3.0	3.0	3.0	
	≤ 300 Bhn or ≤ 32 HRc	60	RPM	1834	1222	917	611	458	306	229	
		(48-72)	Fr	0.0007	0.0011	0.0014	0.0021	0.0028	0.0043	0.0057	
			Feed (ipm)	1.3	1.3	1.3	1.3	1.3	1.3	1.3	
	≤ 425 Bhn or ≤ 45 HRc	45	RPM	1375	917	688	458	344	229	172	
		(36-54)	Fr	0.0004	0.0007	0.0009	0.0013	0.0017	0.0026	0.0035	
			Feed (ipm)	0.6	0.6	0.6	0.6	0.6	0.6	0.6	
	H ALLOY STEELS 4140, 4150, 4320, 5120, 5150, 8630, 86L20, 50100	≤ 275 Bhn or ≤ 28 HRc	95	RPM	2903	1935	1452	968	726	484	363
			(76-114)	Fr	0.0007	0.0010	0.0014	0.0021	0.0028	0.0041	0.0055
				Feed (ipm)	2.0	2.0	2.0	2.0	2.0	2.0	2.0
≤ 375 Bhn or ≤ 40 HRc		60	RPM	1834	1222	917	611	458	306	229	
		(48-72)	Fr	0.0007	0.0010	0.0013	0.0020	0.0026	0.0039	0.0052	
			Feed (ipm)	1.2	1.2	1.2	1.2	1.2	1.2	1.2	
≤ 450 Bhn or ≤ 48 HRc		35	RPM	1070	713	535	357	267	178	134	
		(28-42)	Fr	0.0004	0.0006	0.0007	0.0011	0.0015	0.0022	0.0030	
			Feed (ipm)	0.4	0.4	0.4	0.4	0.4	0.4	0.4	
K TOOL STEELS A2, D2, H13, L2, M2, P20, S7, T15, W2		≤ 250 Bhn or ≤ 24 HRc	35	RPM	1070	713	535	357	267	178	134
			(28-42)	Fr	0.0004	0.0006	0.0007	0.0011	0.0015	0.0022	0.0030
				Feed (ipm)	0.4	0.4	0.4	0.4	0.4	0.4	0.4
	≤ 375 Bhn or ≤ 40 HRc	25	RPM	764	509	382	255	191	127	96	
		(20-30)	Fr	0.0003	0.0004	0.0005	0.0008	0.0010	0.0016	0.0021	
			Feed (ipm)	0.2	0.2	0.2	0.2	0.2	0.2	0.2	
	≤ 475 Bhn or ≤ 50 HRc	20	RPM	611	407	306	204	153	102	76	
		(16-24)	Fr	0.0002	0.0002	0.0003	0.0005	0.0007	0.0010	0.0013	
			Feed (ipm)	0.1	0.1	0.1	0.1	0.1	0.1	0.1	
	M CAST IRONS Gray, Malleable, Ductile	≤ 220 Bhn or ≤ 19 HRc	105	RPM	3209	2139	1604	1070	802	535	401
			(84-126)	Fr	0.0009	0.0014	0.0018	0.0027	0.0036	0.0054	0.0072
				Feed (ipm)	2.9	2.9	2.9	2.9	2.9	2.9	2.9
≤ 330 Bhn or ≤ 36 HRc		75	RPM	2292	1528	1146	764	573	382	287	
		(60-90)	Fr	0.0009	0.0014	0.0018	0.0027	0.0037	0.0055	0.0073	
			Feed (ipm)	2.1	2.1	2.1	2.1	2.1	2.1	2.1	
M STAINLESS STEELS (FREE MACHINING) 303, 416, 420F, 430F 440F		≤ 250 Bhn or ≤ 24 HRc	53	RPM	1620	1080	810	540	405	270	202
			(42-64)	Fr	0.0004	0.0006	0.0009	0.0013	0.0017	0.0026	0.0035
				Feed (ipm)	0.7	0.7	0.7	0.7	0.7	0.7	0.7
		≤ 330 Bhn or ≤ 36 HRc	46	RPM	1406	937	703	469	351	234	176
			(37-55)	Fr	0.0004	0.0005	0.0007	0.0011	0.0014	0.0021	0.0028
				Feed (ipm)	0.5	0.5	0.5	0.5	0.5	0.5	0.5
	STAINLESS STEELS (DIFFICULT) 304, 316, 321, 13-8 PH, 15-5PH, 17-4 PH, Custom 450	≤ 275 Bhn or ≤ 28 HRc	28	RPM	856	570	428	285	214	143	107
			(22-34)	Fr	0.0005	0.0007	0.0009	0.0014	0.0019	0.0028	0.0037
				Feed (ipm)	0.4	0.4	0.4	0.4	0.4	0.4	0.4
		≤ 375 Bhn or ≤ 40 HRc	21	RPM	642	428	321	214	160	107	80
			(17-25)	Fr	0.0002	0.0002	0.0003	0.0005	0.0006	0.0009	0.0012
				Feed (ipm)	0.1	0.1	0.1	0.1	0.1	0.1	0.1

continued on next page

3 Flute Countersink

Series 603 Fractional	Hardness	Vc (sfm)	Diameter (D ₁) (inch)								
			1/8	3/16	1/4	3/8	1/2	3/4	1		
S SUPER ALLOYS (NICKEL, COBALT, IRON BASE) Inconel 601, 617, 625, Incoloy 800, Monel 400, Rene, Waspaloy	≤ 220 Bhn or ≤ 19 HRc	18	RPM	550	367	275	183	138	92	69	
		(14-22)	Fr	0.0004	0.0005	0.0007	0.0011	0.0015	0.0022	0.0029	
			Feed (ipm)	0.2	0.2	0.2	0.2	0.2	0.2	0.2	
	≤ 320 Bhn or ≤ 34 HRc	14	RPM	428	285	214	143	107	71	53	
		(11-17)	Fr	0.0002	0.0004	0.0005	0.0007	0.0009	0.0014	0.0019	
			Feed (ipm)	0.1	0.1	0.1	0.1	0.1	0.1	0.1	
	≤ 425 Bhn or ≤ 45 HRc	12	RPM	367	244	183	122	92	61	46	
		(10-14)	Fr	0.0003	0.0004	0.0005	0.0008	0.0011	0.0016	0.0022	
			Feed (ipm)	0.1	0.1	0.1	0.1	0.1	0.1	0.1	
	N TITANIUM ALLOYS Pure Titanium, Ti6Al4V, Ti6Al2Sn4Zr2Mo, Ti4Al4Mo2Sn0.5Si, Ti-6Al4V	≤ 275 Bhn or ≤ 28 HRc	36	RPM	1100	733	550	367	275	183	138
			(29-43)	Fr	0.0007	0.0011	0.0015	0.0022	0.0029	0.0044	0.0058
				Feed (ipm)	0.8	0.8	0.8	0.8	0.8	0.8	0.8
≤ 350 Bhn or ≤ 38 HRc		28	RPM	856	570	428	285	214	143	107	
		(22-34)	Fr	0.0006	0.0009	0.0012	0.0018	0.0023	0.0035	0.0047	
			Feed (ipm)	0.5	0.5	0.5	0.5	0.5	0.5	0.5	
≤ 440 Bhn or ≤ 47 HRc		21	RPM	642	428	321	214	160	107	80	
		(17-25)	Fr	0.0002	0.0002	0.0003	0.0005	0.0006	0.0009	0.0012	
			Feed (ipm)	0.1	0.1	0.1	0.1	0.1	0.1	0.1	
N ALUMINUM ALLOYS 2017, 2024, 356, 6061, 7075		≤ 80 Bhn or ≤ 47 HRb	225	RPM	6876	4584	3438	2292	1719	1146	860
			(180-270)	Fr	0.0011	0.0017	0.0023	0.0034	0.0045	0.0068	0.0091
				Feed (ipm)	7.8	7.8	7.8	7.8	7.8	7.8	7.8
	≤ 150 Bhn or ≤ 7 HRc	190	RPM	5806	3871	2903	1935	1452	968	726	
		(152-228)	Fr	0.0011	0.0017	0.0022	0.0034	0.0045	0.0067	0.0090	
			Feed (ipm)	6.5	6.5	6.5	6.5	6.5	6.5	6.5	
	≤ 140 Bhn or ≤ 3 HRc	95	RPM	2903	1935	1452	968	726	484	363	
		(76-114)	Fr	0.0006	0.0009	0.0012	0.0018	0.0023	0.0035	0.0047	
			Feed (ipm)	1.7	1.7	1.7	1.7	1.7	1.7	1.7	
	≤ 200 Bhn or ≤ 23 HRc	80	RPM	2445	1630	1222	815	611	407	306	
		(64-96)	Fr	0.0006	0.0009	0.0011	0.0017	0.0023	0.0034	0.0046	
			Feed (ipm)	1.4	1.4	1.4	1.4	1.4	1.4	1.4	

Bhn (Brinell) HRc (Rockwell C) HRb (Rockwell B)

rpm = Vc x 3.82 / D₁

ipm = Fr x rpm

reduce speed and feed for materials harder than listed

refer to the KYOCERA SGS Tool Wizard® for complete technical information (www.kyocera-sgstool.com)

6 Flute Countersink

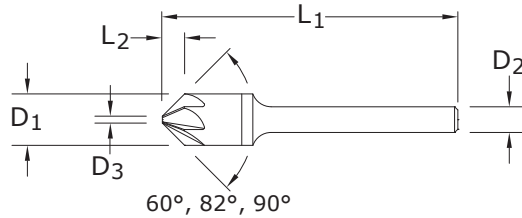

606

FRACTIONAL SERIES

CUTTING DIAMETER D ₁	SHANK DIAMETER D ₂	OVERALL LENGTH L ₁	TIP DIAMETER D ₃	EDP NO.		
				UNCOATED 60°	UNCOATED 82°	UNCOATED 90°
1/8	1/8	1-1/2	.035	—	—	74249
1/8	1/8	1-1/2	.035	—	74149	—
1/8	1/8	1-1/2	.035	74049	—	—
3/16	3/16	2	.045	—	—	74252
3/16	3/16	2	.045	—	74152	—
3/16	3/16	2	.045	74052	—	—
1/4	1/4	2	.070	—	—	74255
1/4	1/4	2	.070	—	74155	—
1/4	1/4	2	.070	74055	—	—
3/8*	1/4	2-13/16	.100	—	—	74258
3/8*	1/4	2-13/16	.100	—	74158	—
3/8*	1/4	2-13/16	.100	74058	—	—
1/2*	1/4	2-7/8	.160	—	—	74261
1/2*	1/4	2-7/8	.160	—	74161	—
1/2*	1/4	2-7/8	.160	74061	—	—
5/8*	3/8	3	.190	—	—	74264
5/8*	3/8	3	.190	—	74164	—
5/8*	3/8	3	.190	74064	—	—
3/4*	1/2	3	.220	—	—	74267
3/4*	1/2	3	.220	—	74167	—
3/4*	1/2	3	.220	74067	—	—
1*	1/2	3-1/4	.260	—	—	74270
1*	1/2	3-1/4	.260	—	74170	—
1*	1/2	3-1/4	.260	74070	—	—

*Steel Shank / Con mango de acero / Avec queue en acier / Mit Stahlschaft
 NOTE: D₃ dimension varies based on angle. Contact your KSPT representative or consult KYOCERA SGS Tool Wizard® for dimension information.

TOLERANCES (inch)

1/8–1/4 DIAMETER

D₁ = +.0000/–.0005

3/8–1 DIAMETER

D₁ = +.003/–.000

Included Angle
 +1°/–1°

- STEELS
- STAINLESS STEELS
- CAST IRON
- HIGH TEMP ALLOYS
- TITANIUM
- NON-FERROUS
- HARDENED STEELS

For patent information visit www.ksptpatents.com

6 Flute Countersink

Series 606 Fractional	Hardness	Vc (sfm)	Diameter (D ₁) (inch)								
			1/8	3/16	1/4	3/8	1/2	3/4	1		
P CARBON STEELS 1018, 1040, 1080, 1090, 10L50, 1140, 1212, 12L15, 1525, 1536	≤ 175 Bhn or ≤ 7 HRc	125	RPM	3820	2547	1910	1273	955	637	478	
		(100-150)	Fr	0.0010	0.0016	0.0021	0.0031	0.0042	0.0063	0.0084	
			Feed (ipm)	4.0	4.0	4.0	4.0	4.0	4.0	4.0	
	≤ 300 Bhn or ≤ 32 HRc	60	RPM	1834	1222	917	611	458	306	229	
		(48-72)	Fr	0.0010	0.0015	0.0020	0.0029	0.0039	0.0059	0.0079	
			Feed (ipm)	1.8	1.8	1.8	1.8	1.8	1.8	1.8	
	≤ 425 Bhn or ≤ 45 HRc	45	RPM	1375	917	688	458	344	229	172	
		(36-54)	Fr	0.0006	0.0009	0.0012	0.0017	0.0023	0.0035	0.0047	
			Feed (ipm)	0.8	0.8	0.8	0.8	0.8	0.8	0.8	
	H ALLOY STEELS 4140, 4150, 4320, 5120, 5150, 8630, 86L20, 50100	≤ 275 Bhn or ≤ 28 HRc	95	RPM	2903	1935	1452	968	726	484	363
			(76-114)	Fr	0.0009	0.0013	0.0018	0.0027	0.0036	0.0054	0.0072
				Feed (ipm)	2.6	2.6	2.6	2.6	2.6	2.6	2.6
≤ 375 Bhn or ≤ 40 HRc		60	RPM	1834	1222	917	611	458	306	229	
		(48-72)	Fr	0.0009	0.0014	0.0019	0.0028	0.0037	0.0056	0.0074	
			Feed (ipm)	1.7	1.7	1.7	1.7	1.7	1.7	1.7	
≤ 450 Bhn or ≤ 48 HRc		35	RPM	1070	713	535	357	267	178	134	
		(28-42)	Fr	0.0006	0.0008	0.0011	0.0017	0.0022	0.0034	0.0045	
			Feed (ipm)	0.6	0.6	0.6	0.6	0.6	0.6	0.6	
K TOOL STEELS A2, D2, H13, L2, M2, P20, S7, T15, W2		≤ 250 Bhn or ≤ 24 HRc	35	RPM	1070	713	535	357	267	178	134
			(28-42)	Fr	0.0006	0.0008	0.0011	0.0017	0.0022	0.0034	0.0045
				Feed (ipm)	0.6	0.6	0.6	0.6	0.6	0.6	0.6
	≤ 375 Bhn or ≤ 40 HRc	25	RPM	764	509	382	255	191	127	96	
		(20-30)	Fr	0.0003	0.0004	0.0005	0.0008	0.0010	0.0016	0.0021	
			Feed (ipm)	0.2	0.2	0.2	0.2	0.2	0.2	0.2	
	≤ 475 Bhn or ≤ 50 HRc	20	RPM	611	407	306	204	153	102	76	
		(16-24)	Fr	0.0003	0.0005	0.0007	0.0010	0.0013	0.0020	0.0026	
			Feed (ipm)	0.2	0.2	0.2	0.2	0.2	0.2	0.2	
	K CAST IRONS Gray, Malleable, Ductile	≤ 220 Bhn or ≤ 19 HRc	105	RPM	3209	2139	1604	1070	802	535	401
			(84-126)	Fr	0.0012	0.0018	0.0024	0.0036	0.0049	0.0073	0.0097
				Feed (ipm)	3.9	3.9	3.9	3.9	3.9	3.9	3.9
≤ 330 Bhn or ≤ 36 HRc		75	RPM	2292	1528	1146	764	573	382	287	
		(60-90)	Fr	0.0012	0.0018	0.0024	0.0037	0.0049	0.0073	0.0098	
			Feed (ipm)	2.8	2.8	2.8	2.8	2.8	2.8	2.8	

continued on next page

6 Flute Countersink

Series 606 Fractional	Hardness	Vc (sfm)	Diameter (D ₁) (inch)								
			1/8	3/16	1/4	3/8	1/2	3/4	1		
M STAINLESS STEELS (FREE MACHINING) 303, 416, 420F, 430F 440F	≤ 250 Bhn or ≤ 24 HRc	53	RPM	1620	1080	810	540	405	270	202	
		(42-64)	Fr	0.0006	0.0009	0.0012	0.0019	0.0025	0.0037	0.0049	
			Feed (ipm)	1.0	1.0	1.0	1.0	1.0	1.0	1.0	
	≤ 330 Bhn or ≤ 36 HRc	46	RPM	1406	937	703	469	351	234	176	
		(37-55)	Fr	0.0005	0.0007	0.0010	0.0015	0.0020	0.0030	0.0040	
			Feed (ipm)	0.7	0.7	0.7	0.7	0.7	0.7	0.7	
	S STAINLESS STEELS (DIFFICULT) 304, 316, 321, 13-8 PH, 15-5PH, 17-4 PH, Custom 450	≤ 275 Bhn or ≤ 28 HRc	28	RPM	856	570	428	285	214	143	107
			(22-34)	Fr	0.0007	0.0011	0.0014	0.0021	0.0028	0.0042	0.0056
				Feed (IPM)	0.6	0.6	0.6	0.6	0.6	0.6	0.6
		≤ 375 Bhn or ≤ 40 HRc	21	RPM	642	428	321	214	160	107	80
			(17-25)	Fr	0.0003	0.0005	0.0006	0.0009	0.0012	0.0019	0.0025
				Feed (IPM)	0.2	0.2	0.2	0.2	0.2	0.2	0.2
S SUPER ALLOYS (NICKEL, COBALT, IRON BASE) Inconel 601, 617, 625, Incoloy 800, Monel 400, Rene, Waspaloy		≤ 220 Bhn or ≤ 19 HRc	18	RPM	550	367	275	183	138	92	69
			(14-22)	Fr	0.0005	0.0008	0.0011	0.0016	0.0022	0.0033	0.0044
				Feed (ipm)	0.3	0.3	0.3	0.3	0.3	0.3	0.3
		≤ 320 Bhn or ≤ 34 HRc	14	RPM	428	285	214	143	107	71	53
			(11-17)	Fr	0.0005	0.0007	0.0009	0.0014	0.0019	0.0028	0.0037
				Feed (ipm)	0.2	0.2	0.2	0.2	0.2	0.2	0.2
	≤ 425 Bhn or ≤ 45 HRc	12	RPM	367	244	183	122	92	61	46	
		(10-14)	Fr	0.0003	0.0004	0.0005	0.0008	0.0011	0.0016	0.0022	
			Feed (ipm)	0.1	0.1	0.1	0.1	0.1	0.1	0.1	
	S TITANIUM ALLOYS Pure Titanium, Ti6Al4V, Ti6Al2Sn4Zr2Mo, Ti4Al4Mo2Sn0.5Si, Ti-6Al4V	≤ 275 Bhn or ≤ 28 HRc	36	RPM	1100	733	550	367	275	183	138
			(29-43)	Fr	0.0009	0.0014	0.0018	0.0027	0.0036	0.0055	0.0073
				Feed (ipm)	1.0	1.0	1.0	1.0	1.0	1.0	1.0
≤ 350 Bhn or ≤ 38 HRc		28	RPM	856	570	428	285	214	143	107	
		(22-34)	Fr	0.0007	0.0011	0.0014	0.0021	0.0028	0.0042	0.0056	
			Feed (ipm)	0.6	0.6	0.6	0.6	0.6	0.6	0.6	
≤ 440 Bhn or ≤ 47 HRc		21	RPM	642	428	321	214	160	107	80	
		(17-25)	Fr	0.0003	0.0005	0.0006	0.0009	0.0012	0.0019	0.0025	
			Feed (ipm)	0.2	0.2	0.2	0.2	0.2	0.2	0.2	

continued on next page

6 Flute Countersink

Series 606 Fractional	Hardness	Vc (sfm)		Diameter (D ₁) (inch)						
				1/8	3/16	1/4	3/8	1/2	3/4	1
ALUMINUM ALLOYS 2017, 2024, 356, 6061, 7075	≤ 80 Bhn or ≤ 47 HRb	225 (180-270)	RPM	6876	4584	3438	2292	1719	1146	860
			Fr	0.0015	0.0022	0.0030	0.0045	0.0060	0.0090	0.0120
			Feed (ipm)	10.3	10.3	10.3	10.3	10.3	10.3	10.3
	≤ 150 Bhn or ≤ 7 HRc	190 (152-228)	RPM	5806	3871	2903	1935	1452	968	726
			Fr	0.0015	0.0022	0.0030	0.0045	0.0060	0.0090	0.0120
			Feed (ipm)	8.7	8.7	8.7	8.7	8.7	8.7	8.7
COPPER ALLOYS Alum Bronze, C110, Muntz Brass	≤ 140 Bhn or ≤ 3 HRc	95 (76-114)	RPM	2903	1935	1452	968	726	484	363
			Fr	0.0008	0.0011	0.0015	0.0023	0.0030	0.0045	0.0061
			Feed (ipm)	2.2	2.2	2.2	2.2	2.2	2.2	2.2
	≤ 200 Bhn or ≤ 23 HRc	80 (64-96)	RPM	2445	1630	1222	815	611	407	306
			Fr	0.0008	0.0012	0.0016	0.0023	0.0031	0.0047	0.0062
			Feed (ipm)	1.9	1.9	1.9	1.9	1.9	1.9	1.9

Bhn (Brinell) HRc (Rockwell C) HRb (Rockwell B)

$rpm = Vc \times 3.82 / D_1$

$ipm = Fr \times rpm$

reduce speed and feed for materials harder than listed

refer to the KYOCERA SGS Tool Wizard® for complete technical information (www.kyocera-sgstool.com)

Straight Flute Accu-Reamer



5xD



200

FRACTIONAL SERIES

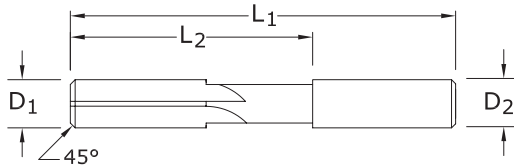

inch					EDP NO.
CUTTING DIAMETER D ₁	SHANK DIAMETER D ₂	MAXIMUM REAM LENGTH L ₂	OVERALL LENGTH L ₁	NO. OF FLUTES	UNCOATED
3/64	3/64	3/4	1-1/2	4	70003
1/16	1/16	3/4	1-1/2	4	70004
5/64	5/64	1	2	4	70005
3/32	3/32	1-1/4	2-1/4	4	70006
7/64	7/64	1-1/4	2-1/4	4	70007
1/8	1/8	1-1/4	2-1/4	4	70008
9/64	9/64	1-1/2	2-1/2	4	70009
5/32	5/32	1-1/2	2-1/2	4	70010
11/64	11/64	1-3/4	2-3/4	4	70011
3/16	3/16	1-3/4	2-3/4	4	70012
13/64	13/64	2	3	4	70013
7/32	7/32	2	3	4	70014
15/64	15/64	2	3	4	70015
1/4	1/4	2	3	4	70016
17/64	17/64	2-1/4	3-1/4	6	70017
9/32	9/32	2-1/4	3-1/4	6	70018
19/64	19/64	2-1/4	3-1/4	6	70019
5/16	5/16	2-1/4	3-1/4	6	70020
21/64	21/64	2-3/8	3-1/2	6	70021
11/32	11/32	2-3/8	3-1/2	6	70022
23/64	23/64	2-3/8	3-1/2	6	70023
3/8	3/8	2-3/8	3-1/2	6	70024
25/64	25/64	2-7/8	4	6	70025
13/32	13/32	2-7/8	4	6	70026
27/64	27/64	2-7/8	4	6	70027
7/16	7/16	2-7/8	4	6	70028
29/64	29/64	2-7/8	4	6	70029
15/32	15/32	2-7/8	4	6	70030
31/64	31/64	2-7/8	4	6	70031
1/2	1/2	2-7/8	4	6	70032

TOLERANCES (inch)

D₁ = +.0002/-0.0000
D₂ = +.0002/-0.0000

- STEELS
- STAINLESS STEELS
- CAST IRON
- HIGH TEMP ALLOYS
- TITANIUM
- NON-FERROUS
- HARDENED STEELS

For patent information visit www.ksptpatents.com

Straight Flute Accu-Reamer

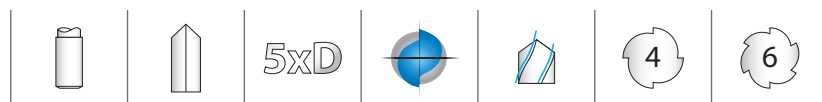

TOLERANCES (inch)

D₁ = +.0002/-0.0000

D₂ = +.0002/-0.0000

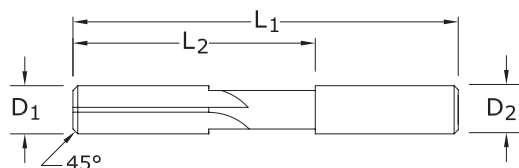

200
FRACTIONAL SERIES

inch				NO. OF FLUTES
CUTTING DIAMETER D ₁	SHANK DIAMETER D ₂	MAXIMUM REAM LENGTH L ₂	OVERALL LENGTH L ₁	
.0470 – .0625	1/16	3/4	1-1/2	4
.0626 – .0781	5/64	1	2	4
.0782 – .0938	3/32	1-1/4	2-1/4	4
.0939 – .1094	7/64	1-1/4	2-1/4	4
.1095 – .1250	1/8	1-1/4	2-1/4	4
.1251 – .1406	9/64	1-1/2	2-1/2	4
.1407 – .1562	5/32	1-1/2	2-1/2	4
.1563 – .1719	11/64	1-3/4	2-3/4	4
.1720 – .1875	3/16	1-3/4	2-3/4	4
.1876 – .2031	13/64	2	3	4
.2032 – .2188	7/32	2	3	4
.2189 – .2344	15/64	2	3	4
.2345 – .2500	1/4	2	3	4
.2501 – .2656	17/64	2-1/4	3-1/4	6
.2657 – .2812	9/32	2-1/4	3-1/4	6
.2813 – .2969	19/64	2-1/4	3-1/4	6
.2970 – .3125	5/16	2-1/4	3-1/4	6
.3126 – .3281	21/64	2-3/8	3-1/2	6
.3282 – .3438	11/32	2-3/8	3-1/2	6
.3439 – .3594	23/64	2-3/8	3-1/2	6
.3595 – .3750	3/8	2-3/8	3-1/2	6
.3751 – .3906	25/64	2-7/8	4	6
.3907 – .4062	13/32	2-7/8	4	6
.4063 – .4219	27/64	2-7/8	4	6
.4220 – .4375	7/16	2-7/8	4	6
.4376 – .4531	29/64	2-7/8	4	6
.4532 – .4688	15/32	2-7/8	4	6
.4689 – .4844	31/64	2-7/8	4	6
.4845 – .5000	1/2	2-7/8	4	6

SER 200 Fractional reamers can be ordered to specific diameters according to the size range of Cutting Diameter D₁. Please order as:

- 200. Then the size of the cut diameter in fractional format.
 - i.e. 200.0492
 - Description: Series 200 size 0.0492
 - For Metric sizes convert to fractional inches (i.e. ÷ 25.4)
 - The above sample would be a 1.25mm size (1.25 ÷ 25.4 = 0.0492")
- All other dimensions are fractional as per table including the Shank

Straight Flute Accu-Reamer

Series 200 Fractional	Hardness	Vc (sfm)	Diameter (D ₁) (inch)								
			1/16	1/8	3/16	1/4	5/16	3/8	1/2		
P CARBON STEELS 1018, 1040, 1080, 1090, 10L50, 1140, 1212, 12L15, 1525, 1536	≤ 175 Bhn or ≤ 7 HRc	150	RPM	9168	4584	3056	2292	1834	1528	1146	
		(120-180)	Fr	0.0018	0.0035	0.0053	0.0071	0.0088	0.0106	0.0141	
			Feed (ipm)	16.5	16.0	16.2	16.3	16.1	16.2	16.2	
	≤ 300 Bhn or ≤ 32 HRc	75	RPM	4584	2292	1528	1146	917	764	573	
		(60-90)	Fr	0.0016	0.0031	0.0047	0.0062	0.0078	0.0093	0.0124	
			Feed (ipm)	7.3	7.1	7.2	7.1	7.2	7.1	7.1	
	≤ 425 Bhn or ≤ 45 HRc	55	RPM	3362	1681	1121	840	672	560	420	
		(44-66)	Fr	0.0009	0.0019	0.0028	0.0037	0.0046	0.0056	0.0074	
			Feed (ipm)	3.0	3.2	3.1	3.1	3.1	3.1	3.1	
	ALLOY STEELS 4140, 4150, 4320, 5120, 5150, 8630, 86L20, 50100	≤ 275 Bhn or ≤ 28 HRc	115	RPM	7029	3514	2343	1757	1406	1171	879
			(92-138)	Fr	0.0015	0.0030	0.0045	0.0060	0.0075	0.0090	0.0120
				Feed (ipm)	10.5	10.5	10.5	10.5	10.5	10.5	10.5
		≤ 375 Bhn or ≤ 40 HRc	70	RPM	4278	2139	1426	1070	856	713	535
			(56-84)	Fr	0.0015	0.0030	0.0045	0.0060	0.0075	0.0090	0.0120
				Feed (ipm)	6.4	6.4	6.4	6.4	6.4	6.4	6.4
≤ 450 Bhn or ≤ 48 HRc		45	RPM	2750	1375	917	688	550	458	344	
		(36-54)	Fr	0.0009	0.0019	0.0028	0.0037	0.0046	0.0056	0.0074	
			Feed (ipm)	2.5	2.6	2.6	2.5	2.5	2.6	2.5	
H TOOL STEELS A2, D2, H13, L2, M2, P20, S7, T15, W2	≤ 250 Bhn or ≤ 24 HRc	40	RPM	2445	1222	815	611	489	407	306	
		(32-48)	Fr	0.0010	0.0020	0.0029	0.0039	0.0049	0.0059	0.0078	
			Feed (ipm)	2.4	2.4	2.4	2.4	2.4	2.4	2.4	
	≤ 375 Bhn or ≤ 40 HRc	25	RPM	1528	764	509	382	306	255	191	
		(20-30)	Fr	0.0006	0.0013	0.0019	0.0025	0.0031	0.0038	0.0050	
			Feed (ipm)	0.9	1.0	1.0	1.0	0.9	1.0	1.0	
	≤ 475 Bhn or ≤ 50 HRc	20	RPM	1222	611	407	306	244	204	153	
		(16-24)	Fr	0.0004	0.0008	0.0012	0.0016	0.0019	0.0023	0.0031	
			Feed (ipm)	0.5	0.5	0.5	0.5	0.5	0.5	0.5	
	≤ 655 Bhn or ≤ 60 HRc	14	RPM	856	428	285	214	171	143	107	
		(11-17)	Fr	0.0003	0.0007	0.0011	0.0014	0.0018	0.0021	0.0028	
			Feed (ipm)	0.3	0.3	0.3	0.3	0.3	0.3	0.3	
K CAST IRONS Gray, Malleable, Ductile	≤ 220 Bhn or ≤ 19 HRc	125	RPM	7640	3820	2547	1910	1528	1273	955	
		(100-150)	Fr	0.0020	0.0040	0.0060	0.0081	0.0101	0.0121	0.0161	
			Feed (ipm)	15.3	15.3	15.3	15.5	15.4	15.4	15.4	
	≤ 330 Bhn or ≤ 36 HRc	95	RPM	5806	2903	1935	1452	1161	968	726	
		(76-114)	Fr	0.0020	0.0040	0.0060	0.0081	0.0101	0.0121	0.0161	
			Feed (ipm)	11.6	11.6	11.6	11.8	11.7	11.7	11.7	
M STAINLESS STEELS (FREE MACHINING) 303, 416, 420F, 430F 440F	≤ 250 Bhn or ≤ 24 HRc	75	RPM	4584	2292	1528	1146	917	764	573	
		(60-90)	Fr	0.0010	0.0020	0.0029	0.0039	0.0049	0.0059	0.0078	
			Feed (ipm)	4.6	4.6	4.4	4.5	4.5	4.5	4.5	
	≤ 330 Bhn or ≤ 36 HRc	55	RPM	3362	1681	1121	840	672	560	420	
		(44-66)	Fr	0.0008	0.0015	0.0023	0.0030	0.0038	0.0045	0.0060	
			Feed (ipm)	2.7	2.5	2.6	2.5	2.6	2.5	2.5	
	STAINLESS STEELS (DIFFICULT) 304, 316, 321, 13-8 PH, 15-5PH, 17-4 PH, Custom 450	≤ 275 Bhn or ≤ 28 HRc	35	RPM	2139	1070	713	535	428	357	267
			(28-42)	Fr	0.0010	0.0020	0.0029	0.0039	0.0049	0.0059	0.0078
				Feed (ipm)	2.1	2.1	2.1	2.1	2.1	2.1	2.1
		≤ 375 Bhn or ≤ 40 HRc	25	RPM	1528	764	509	382	306	255	191
			(20-30)	Fr	0.0006	0.0013	0.0019	0.0025	0.0031	0.0038	0.0050
				Feed (ipm)	0.9	1.0	1.0	1.0	0.9	1.0	1.0

continued on next page

Straight Flute Accu-Reamer

Series 200 Fractional	Hardness	Vc (sfm)		Diameter (D ₁) (inch)							
				1/16	1/8	3/16	1/4	5/16	3/8	1/2	
SUPER ALLOYS (NICKEL, COBALT, IRON BASE) Inconel 601, 617, 625, Incoloy 800, Monel 400, Rene, Waspaloy	≤ 220 Bhn or ≤ 19 HRc	20 (16-24)	RPM	1222	611	407	306	244	204	153	
			Fr	0.0008	0.0015	0.0023	0.0030	0.0038	0.0045	0.0060	
			Feed (ipm)	1.0	0.9	0.9	0.9	0.9	0.9	0.9	
	≤ 320 Bhn or ≤ 34 HRc	15 (12-18)	RPM	917	458	306	229	183	153	115	
			Fr	0.0006	0.0013	0.0019	0.0025	0.0031	0.0038	0.0050	
			Feed (ipm)	0.6	0.6	0.6	0.6	0.6	0.6	0.6	
	≤ 425 Bhn or ≤ 45 HRc	10 (8-12)	RPM	611	306	204	153	122	102	76	
			Fr	0.0004	0.0007	0.0011	0.0015	0.0018	0.0022	0.0029	
			Feed (ipm)	0.2	0.2	0.2	0.2	0.2	0.2	0.2	
	TITANIUM ALLOYS Pure Titanium, Ti6Al4V, Ti6Al2Sn4Zr2Mo, Ti4Al4Mo2Sn0.5Si, Ti-6Al4V	≤ 275 Bhn or ≤ 28 HRc	45 (36-54)	RPM	2750	1375	917	688	550	458	344
				Fr	0.0015	0.0030	0.0045	0.0060	0.0075	0.0090	0.0120
				Feed (ipm)	4.1	4.1	4.1	4.1	4.1	4.1	4.1
≤ 350 Bhn or ≤ 38 HRc		35 (28-42)	RPM	2139	1070	713	535	428	357	267	
			Fr	0.0010	0.0020	0.0029	0.0039	0.0049	0.0059	0.0078	
			Feed (ipm)	2.1	2.1	2.1	2.1	2.1	2.1	2.1	
≤ 440 Bhn or ≤ 47 HRc		25 (20-30)	RPM	1528	764	509	382	306	255	191	
			Fr	0.0006	0.0013	0.0019	0.0025	0.0031	0.0038	0.0050	
			Feed (ipm)	0.9	1.0	1.0	1.0	0.9	1.0	1.0	
ALUMINUM ALLOYS 2017, 2024, 356, 6061, 7075		≤ 80 Bhn or ≤ 47 HRb	270 (216-324)	RPM	16502	8251	5501	4126	3300	2750	2063
				Fr	0.0025	0.0050	0.0075	0.0100	0.0125	0.0150	0.0200
				Feed (ipm)	41.3	41.3	41.3	41.3	41.3	41.3	41.3
	≤ 150 Bhn or ≤ 7 HRc	230 (184-276)	RPM	14058	7029	4686	3514	2812	2343	1757	
			Fr	0.0025	0.0050	0.0075	0.0100	0.0125	0.0150	0.0200	
			Feed (ipm)	35.1	35.1	35.1	35.1	35.1	35.1	35.1	
	COPPER ALLOYS Alum Bronze, C110, Muntz Brass	≤ 140 Bhn or ≤ 3 HRc	115 (92-138)	RPM	7029	3514	2343	1757	1406	1171	879
				Fr	0.0013	0.0026	0.0038	0.0051	0.0064	0.0077	0.0102
				Feed (ipm)	9.1	9.1	8.9	9.0	9.0	9.0	9.0
		≤ 200 Bhn or ≤ 23 HRc	95 (76-114)	RPM	5806	2903	1935	1452	1161	968	726
				Fr	0.0013	0.0026	0.0038	0.0051	0.0064	0.0077	0.0102
				Feed (ipm)	7.5	7.5	7.4	7.4	7.4	7.5	7.4

Bhn (Brinell) HRc (Rockwell C) HRb (Rockwell B)

$rpm = Vc \times 3.82 / D_1$

$ipm = Fr \times rpm$

increase speed and feed 30 percent when using coated reamers

reduce speed and feed for materials harder than listed

refer to the KYOCERA SGS Tool Wizard® for complete technical information (www.kyocera-sgstool.com)

METRIC

Straight Flute Reamer



3xD



201M
METRIC SERIES

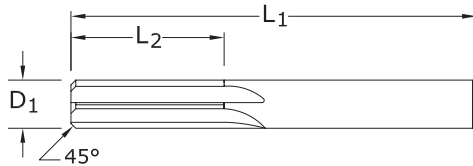

CUTTING DIAMETER D ₁	mm			NO. OF FLUTES	EDP NO. UNCOATED
	MAXIMUM REAM LENGTH L ₂	OVERALL LENGTH L ₁			
1,0	6,0	32,0	4	81001	
1,5	9,5	38,0	4	81003	
2,0	12,7	44,0	4	81005	
2,5	12,7	50,0	4	81007	
3,0	16,0	57,0	4	81009	
3,5	19,0	63,0	4	81011	
4,0	19,0	63,0	4	81013	
4,5	22,0	70,0	4	81015	
5,0	25,0	75,0	4	81017	
5,5	25,0	75,0	4	81019	
6,0	25,0	75,0	4	81021	
7,0	28,0	82,0	6	81023	
8,0	28,0	82,0	6	81025	
9,0	31,0	89,0	6	81027	
10,0	31,0	89,0	6	81029	

TOLERANCES (mm)

1-6 DIAMETER

D₁ = +0,008/-0,000

>6-10 DIAMETER

D₁ = +0,011/-0,000

- STEELS
- STAINLESS STEELS
- CAST IRON
- HIGH TEMP ALLOYS
- TITANIUM
- NON-FERROUS
- HARDENED STEELS

For patent information visit www.ksptpatents.com

Straight Flute Reamer

Series 201M Metric	Hardness	Vc (m/min)	Diameter (D ₁) (mm)								
			1	2	3	4	6	8	10		
P	CARBON STEELS 1018, 1040, 1080, 1090, 10L50, 1140, 1212, 12L15, 1525, 1536	≤ 175 Bhn or ≤ 7 HRc	46	RPM	14541	7271	4847	3635	2424	1818	1454
			(37-55)	Fr	0.028	0.056	0.085	0.113	0.169	0.226	0.282
			Feed (mm/min)	410	410	410	410	410	410	410	
		≤ 300 Bhn or ≤ 32 HRc	23	RPM	7271	3635	2424	1818	1212	909	727
			(18-27)	Fr	0.025	0.050	0.074	0.099	0.149	0.198	0.248
			Feed (mm/min)	180	180	180	180	180	180	180	
	≤ 425 Bhn or ≤ 45 HRc	17	RPM	5332	2666	1777	1333	889	666	533	
		(13-20)	Fr	0.015	0.030	0.044	0.059	0.089	0.119	0.148	
		Feed (mm/min)	79	79	79	79	79	79	79		
	ALLOY STEELS 4140, 4150, 4320, 5120, 5150, 8630, 86L20, 50100	≤ 275 Bhn or ≤ 28 HRc	35	RPM	11148	5574	3716	2787	1858	1394	1115
			(28-42)	Fr	0.024	0.048	0.072	0.096	0.144	0.192	0.240
			Feed (mm/min)	268	268	268	268	268	268	268	
≤ 375 Bhn or ≤ 40 HRc		21	RPM	6786	3393	2262	1696	1131	848	679	
		(17-26)	Fr	0.024	0.048	0.072	0.096	0.144	0.192	0.240	
		Feed (mm/min)	163	163	163	163	163	163	163		
≤ 450 Bhn or ≤ 48 HRc	14	RPM	4362	2181	1454	1091	727	545	436		
	(11-16)	Fr	0.015	0.030	0.045	0.060	0.089	0.119	0.149		
	Feed (mm/min)	65	65	65	65	65	65	65			
H	TOOL STEELS A2, D2, H13, L2, M2, P20, S7, T15, W2	≤ 250 Bhn or ≤ 24 HRc	12	RPM	3878	1939	1293	969	646	485	388
			(10-15)	Fr	0.015	0.031	0.046	0.062	0.093	0.124	0.155
			Feed (mm/min)	60	60	60	60	60	60	60	
		≤ 375 Bhn or ≤ 40 HRc	8	RPM	2424	1212	808	606	404	303	242
			(6-9)	Fr	0.010	0.020	0.030	0.040	0.059	0.079	0.099
			Feed (mm/min)	24	24	24	24	24	24	24	
	≤ 475 Bhn or ≤ 50 HRc	6	RPM	1939	969	646	485	323	242	194	
		(5-7)	Fr	0.006	0.012	0.019	0.025	0.037	0.050	0.062	
		Feed (mm/min)	12	12	12	12	12	12	12		
	≤ 655 Bhn or ≤ 60 HRc	4	RPM	1272	636	424	318	212	159	127	
		(3-5)	Fr	0.006	0.013	0.019	0.025	0.038	0.050	0.063	
		Feed (mm/min)	8	8	8	8	8	8	8		
K	CAST IRONS Gray, Malleable, Ductile	≤ 220 Bhn or ≤ 19 HRc	38	RPM	12118	6059	4039	3029	2020	1515	1212
			(30-46)	Fr	0.032	0.064	0.097	0.129	0.193	0.257	0.322
			Feed (mm/min)	390	390	390	390	390	390	390	
		≤ 330 Bhn or ≤ 36 HRc	29	RPM	9209	4605	3070	2302	1535	1151	921
			(23-35)	Fr	0.032	0.064	0.096	0.128	0.192	0.256	0.320
			Feed (mm/min)	295	295	295	295	295	295	295	

continued on next page

Straight Flute Reamer

Series 201M Metric	Hardness	Vc (m/min)	Diameter (D ₁) (mm)								
			1	2	3	4	6	8	10		
M STAINLESS STEELS (FREE MACHINING) 303, 416, 420F, 430F 440F	≤ 250 Bhn or ≤ 24 HRc	23	RPM	7271	3635	2424	1818	1212	909	727	
		(18-27)	Fr	0.015	0.030	0.045	0.059	0.089	0.119	0.149	
			Feed (mm/min)	108	108	108	108	108	108	108	
	≤ 330 Bhn or ≤ 36 HRc	17	RPM	5332	2666	1777	1333	889	666	533	
		(13-20)	Fr	0.012	0.024	0.036	0.048	0.072	0.096	0.120	
			Feed (mm/min)	64	64	64	64	64	64	64	
	STAINLESS STEELS (DIFFICULT) 304, 316, 321, 13-8 PH, 15-5PH, 17-4 PH, Custom 450	≤ 275 Bhn or ≤ 28 HRc	11	RPM	3393	1696	1131	848	565	424	339
			(9-13)	Fr	0.015	0.029	0.044	0.059	0.088	0.118	0.147
				Feed (mm/min)	50	50	50	50	50	50	50
		≤ 375 Bhn or ≤ 40 HRc	8	RPM	2424	1212	808	606	404	303	242
			(6-9)	Fr	0.010	0.020	0.030	0.040	0.059	0.079	0.099
				Feed (mm/min)	24	24	24	24	24	24	24
S SUPER ALLOYS (NICKEL, COBALT, IRON BASE) Inconel 601, 617, 625, Incoloy 800, Monel 400, Rene, Waspaloy	≤ 220 Bhn or ≤ 19 HRc	6	RPM	1939	969	646	485	323	242	194	
		(5-7)	Fr	0.012	0.024	0.036	0.047	0.071	0.095	0.119	
			Feed (mm/min)	23	23	23	23	23	23	23	
	≤ 320 Bhn or ≤ 34 HRc	5	RPM	1454	727	485	364	242	182	145	
		(4-5)	Fr	0.010	0.021	0.031	0.041	0.062	0.083	0.103	
			Feed (mm/min)	15	15	15	15	15	15	15	
	≤ 425 Bhn or ≤ 45 HRc	3	RPM	969	485	323	242	162	121	97	
		(2-4)	Fr	0.006	0.012	0.019	0.025	0.037	0.050	0.062	
			Feed (mm/min)	6	6	6	6	6	6	6	
	TITANIUM ALLOYS Pure Titanium, Ti6Al4V, Ti6Al2Sn4Zr2Mo, Ti4Al4Mo2Sn0.5Si, Ti-6Al4V	≤ 275 Bhn or ≤ 28 HRc	14	RPM	4362	2181	1454	1091	727	545	436
			(11-16)	Fr	0.024	0.048	0.072	0.096	0.144	0.193	0.241
				Feed (mm/min)	105	105	105	105	105	105	105
≤ 350 Bhn or ≤ 38 HRc		11	RPM	3393	1696	1131	848	565	424	339	
		(9-13)	Fr	0.015	0.029	0.044	0.059	0.088	0.118	0.147	
			Feed (mm/min)	50	50	50	50	50	50	50	
≤ 440 Bhn or ≤ 47 HRc		8	RPM	2424	1212	808	606	404	303	242	
		(6-9)	Fr	0.010	0.020	0.030	0.040	0.059	0.079	0.099	
			Feed (mm/min)	24	24	24	24	24	24	24	

continued on next page

Straight Flute Reamer

Series 201M Metric	Hardness	Vc (m/min)		Diameter (D ₁) (mm)								
				1	2	3	4	6	8	10		
N	ALUMINUM ALLOYS 2017, 2024, 356, 6061, 7075	≤ 80 Bhn or ≤ 47 HRb (66-99)	82	RPM	26174	13087	8725	6544	4362	3272	2617	
				Fr	0.040	0.080	0.120	0.160	0.240	0.320	0.400	
				Feed (mm/min)	1047	1047	1047	1047	1047	1047	1047	
	ALUMINUM ALLOYS 2017, 2024, 356, 6061, 7075	≤ 150 Bhn or ≤ 7 HRc (56-84)	70		RPM	22297	11148	7432	5574	3716	2787	2230
					Fr	0.040	0.080	0.120	0.160	0.240	0.320	0.400
					Feed (mm/min)	892	892	892	892	892	892	892
	COPPER ALLOYS Alum Bronze, C110, Muntz Brass	≤ 140 Bhn or ≤ 3 HRc (28-42)	35		RPM	11148	5574	3716	2787	1858	1394	1115
					Fr	0.020	0.041	0.061	0.081	0.122	0.163	0.204
					Feed (mm/min)	227	227	227	227	227	227	227
COPPER ALLOYS Alum Bronze, C110, Muntz Brass		≤ 200 Bhn or ≤ 23 HRc (23-35)	29		RPM	9209	4605	3070	2302	1535	1151	921
					Fr	0.020	0.041	0.061	0.082	0.122	0.163	0.204
					Feed (mm/min)	188	188	188	188	188	188	188

Bhn (Brinell) HRc (Rockwell C) HRb (Rockwell B)

rpm = (Vc x 1000) / (D₁ x 3.14)

mm/min = Fr x rpm

increase speed and feed 30 percent when using coated reamers

reduce speed and feed for materials harder than listed

refer to the KYOCERA SGS Tool Wizard® for complete technical information (www.kyocera-sgstool.com)

Routers



Routing

HIGH PERFORMANCE ROUTERS			
	SERIES	DESCRIPTION	PAGE
Plastic Composite	29	Multi-Flute Plastic Composite Fractional	352
	29M	Multi-Flute Plastic Composite Metric	354
Carbon Composite	20-CCR	Multi-Flute Carbon Composite Fractional	356
	20M-CCR	Multi-Flute Carbon Composite Metric	359
Coarse Cut Carbon Composite	31-CCR	Multi-Flute Coarse Composite Fractional	362
	31M-CCR	Multi-Flute Coarse Composite Metric	364
Compression	25	Multi-Flute Compression Fractional	366
	25M	Multi-Flute Compression Metric	368
GENERAL PURPOSE ROUTERS			
	SERIES	DESCRIPTION	PAGE
Up Cut	21	2 Flute Up Cut Fractional	370
	21M	2 Flute Up Cut Metric	373
Down Cut	22	2 Flute Down Cut Fractional	371
	22M	2 Flute Down Cut Metric	374

Speed & Feed Recommendations listed after each series

Ranurado

RANURADORES DE ALTO RENDIMIENTO	SERIE	DESCRIPCIÓN	PÁGINA
Compuesto de plástico	29	Filo múltiple, compuesto plástico, fraccional	352
	29M	Filo múltiple, compuesto plástico, métrico	354
Compuesto de carbono	20-CCR	Filo múltiple, compuesto de carbono, fraccional	356
	20M-CCR	Filo múltiple, compuesto de carbono, métrico	359
Compuesto de carbono de corte áspero	31-CCR	Filo múltiple, compuesto áspero, fraccional	362
	31M-CCR	Filo múltiple, compuesto áspero, métrico	364
Compresión	25	Filo múltiple, compresión, fraccional	366
	25M	Filo múltiple, compresión, métrico	368

RANURADORES DE USO GENERAL	SERIE	DESCRIPCIÓN	PÁGINA
Corte ascendente	21	2 fillos, corte ascendente, fraccional	370
	21M	2 fillos, corte ascendente, métrico	373
Corte descendente	22	2 fillos, corte descendente, fraccional	371
	22M	2 fillos, corte descendente, métrico	374

Recomendaciones de velocidades y avances mostradas tras cada serie

Détourage

FRAISES A DETOURER HAUTE PERFORMANCE	SERIES	DESCRIPTION	PAGE
Composites plastique	29	Multi-dents pour composites plastique (fractionnel)	352
	29M	Multi-dents pour composites plastique (métrique)	354
Composites carbone	20-CCR	Multi-dents pour composites carbone (fractionnel)	356
	20M-CCR	Multi-dents pour composites carbone (métrique)	359
Pour composites carbone coupe grossière	31-CCR	Multi-dents pour composites grossiers (fractionnel)	362
	31M-CCR	Multi-dents pour composites grossiers (métrique)	364
Compression	25	Multi-dents de compression (fractionnel)	366
	25M	Multi-dents de compression (métrique)	368

FRAISES À DÉTOURER UNIVERSELLES	SERIES	DESCRIPTION	PAGE
Coupe ascendante	21	2 dents coupe ascendante (fractionnel)	370
	21M	2 dents coupe ascendante (métrique)	373
Coupe descendante	22	2 dents coupe descendante (fractionnel)	371
	22M	2 dents coupe descendante (métrique)	374

Recommandations de vitesse et avance indiquées après chaque série

HOCHLEISTUNGS-OBERFRÄSE	SERIE	BESCHREIBUNG	SEITE
Verbundkunststoff	29	Zöllige Oberfräse mit mehrschneidigen Schneidekanten für Verbundkunststoff	352
	29M	Zöllige Oberfräse mit mehrschneidigen Schneidekanten für Verbundkunststoff	354
Kohlefaserverbundwerkstoff	20-CCR	Zöllige Oberfräse mit mehrschneidigen Schneidekanten für Kohlefaserverbundwerkstoff	356
	20M-CCR	Metrische Oberfräse mit mehrschneidigen Schneidekanten für Kohlefaserverbundwerkstoff	359
Grobschnitt Kohlefaserverbundwerkstoff	31-CCR	Zöllige Oberfräse mit mehrschneidigen Schneidekanten für Verbundkunststoff-Grobschnitt	362
	31M-CCR	Metrische Oberfräse mit mehrschneidigen Schneidekanten für Verbundkunststoff	364
Gegenläufiger Drall	25	Zöllige gegenläufige mehrschneidige Oberfräse	366
	25M	Metrische gegenläufige mehrschneidige Oberfräse	368

ALLZWECK-OBERFRÄSEN	SERIE	BESCHREIBUNG	SEITE
Gegenlauf	21	Zöllige gegenläufige Oberfräse mit 2 Schneidekanten	370
	21M	Zöllige gegenläufige Oberfräse mit 2 Schneidekanten	373
Gleichlauf	22	Zöllige gleichläufige Oberfräse mit 2 Schneidekanten	371
	22M	Zöllige gleichläufige Oberfräse mit 2 Schneidekanten	374

Empfehlungen für Drehzahl & Vorschub im Anhang zu jeder Serie

Plastic Composite

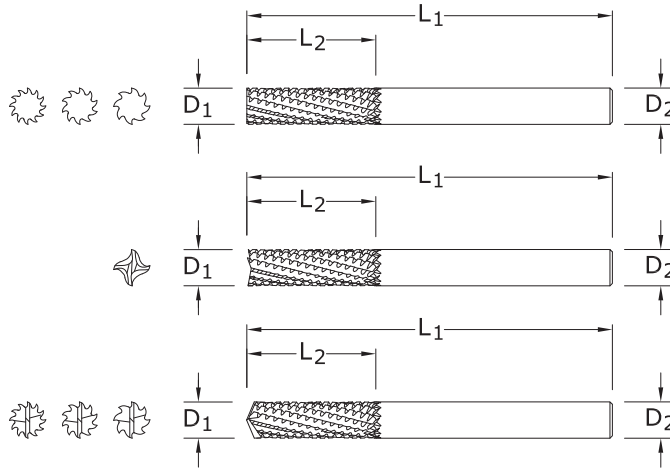

29

FRACTIONAL SERIES

- Radial chisel edge design provides smoother cuts and enhanced tool life
- Eccentric relief and neutral rake for strength
- Excels at trimming and profiling non-filled plastics as well as glass-filled plastics

inch							EDP NO.	
CUTTING DIAMETER D ₁	LENGTH OF CUT L ₂	OVERALL LENGTH L ₁	SHANK DIAMETER D ₂	NO. OF FLUTES	END STYLE	UNCOATED	Di-NAMITE® (Diamond)	
1/8	1/2	1-1/2	1/8	8	No End Cut	74280	75080	
1/8	1/2	1-1/2	1/8	8	End Mill	74281	75081	
1/8	1/2	1-1/2	1/8	8	Drill	74282	75082	
1/4	1	2-1/2	1/4	10	No End Cut	74283	75083	
1/4	1	2-1/2	1/4	10	End Mill	74284	75084	
1/4	1	2-1/2	1/4	10	Drill	74285	75085	
5/16	1	2-1/2	5/16	12	No End Cut	74286	75086	
5/16	1	2-1/2	5/16	12	End Mill	74287	75087	
5/16	1	2-1/2	5/16	12	Drill	74288	75088	
3/8	1-1/8	2-1/2	3/8	12	No End Cut	74289	75089	
3/8	1-1/8	2-1/2	3/8	12	End Mill	74290	75090	
3/8	1-1/8	2-1/2	3/8	12	Drill	74291	75091	

TOLERANCES (inch)

D₁ = +.000/- .005

D₂ = h₆

PLASTICS/COMPOSITES

For patent information visit www.ksptpatents.com

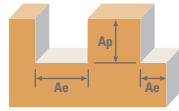

Series 29 Fractional	Ae x D ₁	Ap x D ₁	Vc (sfm)	Diameter (D ₁) (inch)						
				1/8	1/4	5/16	3/8			
CFRP, AFRP (CARBON FIBER, ARAMID FIBER)	Slot 	1	≤ 1	400	RPM	12224	6112	4890	4075	
				(320-480)	Fr	0.0024	0.0048	0.0060	0.0072	
					Feed (ipm)	29	29	29	29	
	Profile 	≤ 0.5	≤ 1.5	500	RPM	15280	7640	6112	5093	
				(400-600)	Fr	0.0024	0.0048	0.0060	0.0072	
					Feed (ipm)	37	37	37	37	
	HSM 	≤ 0.05	≤ 2	825	RPM	25212	12606	10085	8404	
				(660-990)	Fr	0.0055	0.0110	0.0138	0.0165	
					Feed (ipm)	139	139	139	139	
	GFRP (FIBERGLASS)	Slot 	1	≤ 1	320	RPM	9779	4890	3912	3260
					(256-384)	Fr	0.0024	0.0048	0.0060	0.0072
						Feed (ipm)	23	23	23	23
Profile 		≤ 0.5	≤ 1.5	400	RPM	12224	6112	4890	4075	
				(320-480)	Fr	0.0024	0.0048	0.0060	0.0072	
					Feed (ipm)	29	29	29	29	
HSM 		≤ 0.05	≤ 2	660	RPM	20170	10085	8068	6723	
				(528-792)	Fr	0.0055	0.0110	0.0138	0.0165	
					Feed (ipm)	111	111	111	111	
CARBON, GRAPHITE		Slot 	1	≤ 1	480	RPM	14669	7334	5868	4890
					(384-576)	Fr	0.0037	0.0075	0.0094	0.0112
						Feed (ipm)	55	55	55	55
	Profile 	≤ 0.5	≤ 1.5	600	RPM	18336	9168	7334	6112	
				(480-720)	Fr	0.0037	0.0075	0.0094	0.0112	
					Feed (ipm)	69	69	69	69	
	HSM 	≤ 0.05	≤ 2	990	RPM	30254	15127	12102	10085	
				(792-1188)	Fr	0.0086	0.0172	0.0215	0.0258	
					Feed (ipm)	260	260	260	260	
	PLASTICS	Slot 	1	≤ 1	800	RPM	24448	12224	9779	8149
					(640-690)	Fr	0.0038	0.0075	0.0094	0.0113
						Feed (ipm)	92	92	92	92
Profile 		≤ 0.5	≤ 1.5	1000	RPM	30560	15280	12224	10187	
				(800-1200)	Fr	0.0038	0.0075	0.0094	0.0113	
					Feed (ipm)	115	115	115	115	
HSM 		≤ 0.05	≤ 2	1650	RPM	50424	25212	20170	16808	
				(1320-1980)	Fr	0.0035	0.0069	0.0086	0.0104	
					Feed (ipm)	174	174	174	174	

HSM (high speed machining)
 $rpm = Vc \times 3.82 / D_1$
 $ipm = Fr \times rpm$
 adjust parameters based on resin type and fiber structure
 reduce speed when overheating causes melting or damage to resin
 reduce feed if delamination or fraying occur

finish cuts typically required reduced feed and cutting depths
 rates shown are for use without coolant; rates may be increased with coolant
 dust collection is vital when machining dry
 diamond coating will increase tool life in graphite and composite materials
 refer to the KYOCERA SGS Tool Wizard® for complete technical information
 (www.kyocera-sgstool.com)

Plastic Composite

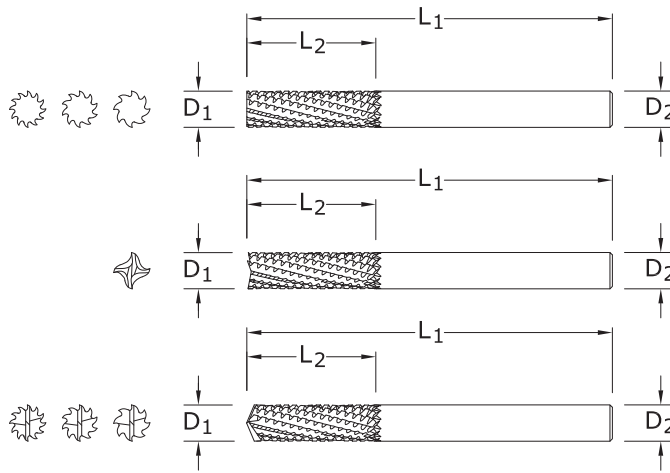

29M METRIC SERIES

- Radial chisel edge design provides smoother cuts and enhanced tool life
- Eccentric relief and neutral rake for strength
- Excels at trimming and profiling non-filled plastics as well as glass-filled plastics

mm						EDP NO.	
CUTTING DIAMETER D ₁	LENGTH OF CUT L ₂	OVERALL LENGTH L ₁	SHANK DIAMETER D ₂	NO. OF FLUTES	END STYLE	UNCOATED	Di-NAMITE® (Diamond)
3,0	12,0	38,0	3,0	8	No End Cut	84280	85080
3,0	12,0	38,0	3,0	8	End Mill	84281	85081
3,0	12,0	38,0	3,0	8	Drill	84282	85082
6,0	25,0	63,0	6,0	10	No End Cut	84283	85083
6,0	25,0	63,0	6,0	10	End Mill	84284	85084
6,0	25,0	63,0	6,0	10	Drill	84285	85085
8,0	25,0	63,0	8,0	12	No End Cut	84286	85086
8,0	25,0	63,0	8,0	12	End Mill	84287	85087
8,0	25,0	63,0	8,0	12	Drill	84288	85088
10,0	25,0	63,0	10,0	12	No End Cut	84289	85089
10,0	25,0	63,0	10,0	12	End Mill	84290	85090
10,0	25,0	63,0	10,0	12	Drill	84291	85091

TOLERANCES (mm)

D₁ = +0,00/-0,13

D₂ = h₆

PLASTICS/COMPOSITES

For patent information visit www.ksptpatents.com

Plastic Composite

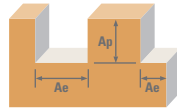

Series 29M Metric	Ae x D ₁	Ap x D ₁	Vc (m/min)	Diameter (D ₁) (mm)					
				3	6	8	10		
CFRP, AFRP (CARBON FIBER, ARAMID FIBER)	Slot 	1	≤ 1	120	RPM	12722	6361	4771	3817
				(96-164)	Fr	0.061	0.122	0.163	0.203
					Feed (mm/min)	776	776	776	776
	Profile 	≤ 0.5	≤ 1.5	150	RPM	15903	7951	5963	4771
				(120-180)	Fr	0.061	0.122	0.163	0.203
					Feed (mm/min)	970	970	970	970
	HSM 	≤ 0.05	≤ 2	250	RPM	26504	13252	9939	7951
				(200-300)	Fr	0.140	0.280	0.373	0.467
					Feed (mm/min)	3710	3710	3710	3710
GFRP (FIBERGLASS)	Slot 	1	≤ 1	100	RPM	10602	5301	3976	3181
				(80-120)	Fr	0.061	0.122	0.162	0.203
					Feed (mm/min)	646	646	646	646
	Profile 	≤ 0.5	≤ 1.5	120	RPM	12722	6361	4771	3817
				(96-164)	Fr	0.061	0.122	0.163	0.203
					Feed (mm/min)	776	776	776	776
	HSM 	≤ 0.05	≤ 2	200	RPM	21203	10602	7951	6361
				(160-240)	Fr	0.140	0.280	0.374	0.467
					Feed (mm/min)	2970	2970	2970	2970
CARBON, GRAPHITE	Slot 	1	≤ 1	145	RPM	15372	7686	5765	4612
				(116-174)	Fr	0.095	0.190	0.253	0.317
					Feed (mm/min)	1460	1460	1460	1460
	Profile 	≤ 0.5	≤ 1.5	185	RPM	19613	9807	7355	5884
				(148-222)	Fr	0.095	0.190	0.253	0.317
					Feed (mm/min)	1863	1863	1863	1863
	HSM 	≤ 0.05	≤ 2	300	RPM	31805	15903	11927	9542
				(240-360)	Fr	0.219	0.437	0.583	0.729
					Feed (mm/min)	6957	6957	6957	6957
PLASTICS	Slot 	1	≤ 1	245	RPM	25974	12987	9740	7792
				(196-294)	Fr	0.037	0.075	0.100	0.125
					Feed (mm/min)	974	974	974	974
	Profile 	≤ 0.5	≤ 1.5	305	RPM	32335	16168	12126	9701
				(244-366)	Fr	0.038	0.075	0.100	0.125
					Feed (mm/min)	1213	1213	1213	1213
	HSM 	≤ 0.05	≤ 2	505	RPM	53538	26769	20077	16062
				(404-606)	Fr	0.088	0.175	0.233	0.292
					Feed (mm/min)	4685	4685	4685	4685

HSM (high speed machining)
 $rpm = (Vc \times 1000) / (D_1 \times 3.14)$
 $mm/min = Fr \times rpm$
 adjust parameters based on resin type and fiber structure
 reduce speed when overheating causes melting or damage to resin
 reduce feed if delamination or fraying occur

finish cuts typically required reduced feed and cutting depths
 rates shown are for use without coolant; rates may be increased with coolant
 dust collection is vital when machining dry
 diamond coating will increase tool life in graphite and composite materials
 refer to the KYOCERA SGS Tool Wizard® for complete technical information
 (www.kyocera-sgstool.com)

Carbon Composite



20-CCR FRACTIONAL SERIES

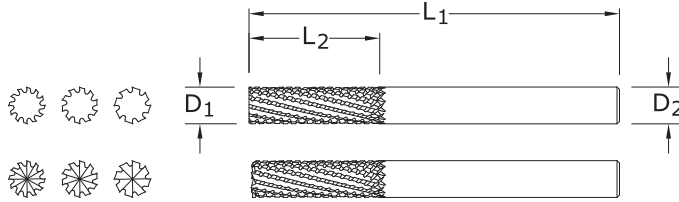

- Multi-flute design and positive geometry to shear with minimal pressure and delamination
- Unique clearance grind minimizes contact between tool diameter and workpiece eliminating friction
- Left hand flutes engineered to control the fibers within CFRP, preventing excessive fiber breakout
- Excels at trimming and profiling difficult and abrasive fiber filled plastics

CUTTING DIAMETER D_1	LENGTH OF CUT L_2	inch				END STYLE	EDP NO.	
		OVERALL LENGTH L_1	SHANK DIAMETER D_2	NO. OF FLUTES	UNCOATED		Di-NAMITE® (Diamond)	
1/4	1	2-1/2	1/4	8	No End Cutting	72930	73013	
1/4	1	2-1/2	1/4	8	End Cutting	72947	73012	
5/16	1	2-1/2	5/16	10	No End Cutting	72948	73026	
5/16	1	2-1/2	5/16	10	End Cutting	72949	73014	
3/8	1-1/8	2-1/2	3/8	12	No End Cutting	72950	73028	
3/8	1-1/8	2-1/2	3/8	12	End Cutting	72951	73027	
1/2	1-1/2	3-1/2	1/2	12	No End Cutting	72952	73041	
1/2	1-1/2	3-1/2	1/2	12	End Cutting	72953	73029	

TOLERANCES (inch)

$D_1 = +.000/-0.005$

$D_2 = h_6$

PLASTICS/COMPOSITES

For patent information visit www.ksptpatents.com



FRACTIONAL Carbon Composite

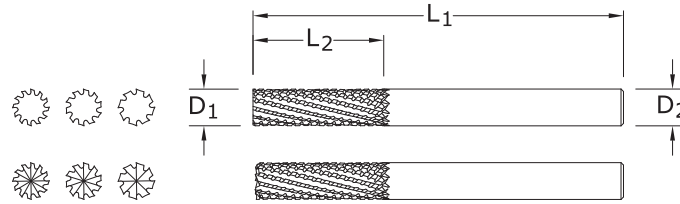

TOLERANCES (inch)

$D_1 = +.000/-0.005$

$D_2 = h_6$

PLASTICS/COMPOSITES

For patent information visit www.ksptpatents.com

20-CCR-LHC FRACTIONAL SERIES

CUTTING DIAMETER D_1	LENGTH OF CUT L_2	OVERALL LENGTH L_1	SHANK DIAMETER D_2	NO. OF FLUTES	END STYLE	EDP NO.	
						UNCOATED	Di-NAMITE® (Diamond)
1/4	1	2-1/2	1/4	8	No End Cutting	73070	73078
1/4	1	2-1/2	1/4	8	End Cutting	73071	73079
5/16	1	2-1/2	5/16	10	No End Cutting	73072	73080
5/16	1	2-1/2	5/16	10	End Cutting	73073	73081
3/8	1-1/8	2-1/2	3/8	12	No End Cutting	73074	73082
3/8	1-1/8	2-1/2	3/8	12	End Cutting	73075	73083

- Multi-flute design and positive geometry to shear with minimal pressure and delamination
- Unique clearance grind minimizes contact between tool diameter and workpiece eliminating friction
- Left hand flutes engineered to control the fibers within CFRP, preventing excessive fiber breakout
- Excels at trimming and profiling difficult and abrasive fiber filled plastics

Carbon Composite

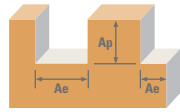

Series 20 Fractional	Ae x D ₁	Ap x D ₁	Vc (sfm)	Diameter (D ₁) (inch)					
				1/4	5/16	3/8	1/2		
CFRP, AFRP (CARBON FIBER, ARAMID FIBER)	Slot 	1	≤ 1	400	RPM	6112	4890	4075	3056
				(320-480)	Fr	0.0049	0.0094	0.0135	0.0180
					Feed (ipm)	30	46	55	55
	Profile 	≤ 0.5	≤ 1.5	500	RPM	7640	6112	5093	3820
				(400-600)	Fr	0.0049	0.0094	0.0135	0.0180
					Feed (ipm)	38	58	69	69
	HSM 	≤ 0.05	≤ 2	825	RPM	12606	10085	8404	6303
				(660-990)	Fr	0.0111	0.0215	0.0309	0.0413
					Feed (ipm)	140	217	260	260
GFRP (FIBERGLASS)	Slot 	1	≤ 1	320	RPM	4890	3912	3260	2445
				(256-384)	Fr	0.0049	0.0095	0.0135	0.0180
					Feed (ipm)	24	37	44	44
	Profile 	≤ 0.5	≤ 1.5	400	RPM	6112	4890	4075	3056
				(320-480)	Fr	0.0049	0.0095	0.0135	0.0180
					Feed (ipm)	30	46	55	55
	HSM 	≤ 0.05	≤ 2	660	RPM	10085	8068	6723	5042
				(528-792)	Fr	0.0110	0.0214	0.0311	0.0414
					Feed (ipm)	111	173	209	209
CARBON, GRAPHITE	Slot 	1	≤ 1	480	RPM	7334	5868	4890	3667
				(384-576)	Fr	0.0064	0.0124	0.0180	0.0240
					Feed (ipm)	47	73	88	88
	Profile 	≤ 0.5	≤ 1.5	600	RPM	9168	7334	6112	4584
				(480-720)	Fr	0.0064	0.0124	0.0180	0.0240
					Feed (ipm)	59	91	110	110
	HSM 	≤ 0.05	≤ 2	990	RPM	15127	12102	10085	7564
				(792-1188)	Fr	0.0147	0.0287	0.0412	0.0549
					Feed (ipm)	223	347	415	415
PLASTICS	Slot 	1	≤ 1	800	RPM	12224	9779	8149	6112
				(640-690)	Fr	0.0064	0.0125	0.0180	0.0241
					Feed (ipm)	78	122	147	147
	Profile 	≤ 0.5	≤ 1.5	1000	RPM	15280	12224	10187	7640
				(800-1200)	Fr	0.0064	0.0125	0.0180	0.0241
					Feed (ipm)	98	153	184	184
	HSM 	≤ 0.05	≤ 2	1650	RPM	25212	20170	16808	12606
				(1320-1980)	Fr	0.0147	0.0287	0.0413	0.0551
					Feed (ipm)	370	579	694	694

HSM (high speed machining)
 $rpm = Vc \times 3.82 / D_1$
 $ipm = Fr \times rpm$
 adjust parameters based on resin type and fiber structure
 reduce speed when overheating causes melting or damage to resin
 reduce feed if delamination or fraying occur

finish cuts typically required reduced feed and cutting depths
 rates shown are for use without coolant; rates may be increased with coolant
 dust collection is vital when machining dry
 diamond coating will increase tool life in graphite and composite materials
 refer to the KYOCERA SGS Tool Wizard® for complete technical information
 (www.kyocera-sgstool.com)

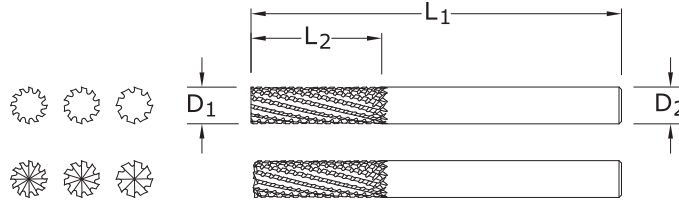

TOLERANCES (mm)

$D_1 = +0,00/-0,13$

$D_2 = h_6$

PLASTICS/COMPOSITES

For patent information visit www.ksptpatents.com

20M-CCR
METRIC SERIES

mm						EDP NO.		
CUTTING DIAMETER D_1	LENGTH OF CUT L_2	OVERALL LENGTH L_1	SHANK DIAMETER D_2	NO. OF FLUTES	END STYLE	UNCOATED	Ti-NAMITE-B (TiB ₂)	Di-NAMITE* (Diamond)
2,0	6,0	38,0	3,0	5	End Cutting	82930	83100	83070
3,0	10,0	38,0	3,0	5	End Cutting	82931	83101	83071
4,0	12,0	50,0	4,0	5	End Cutting	82932	83102	83072
5,0	15,0	50,0	6,0	5	End Cutting	82933	83103	83073
6,0	25,0	63,0	6,0	8	No End Cutting	82966	83104	83027
6,0	25,0	63,0	6,0	8	End Cutting	82967	83105	83026
8,0	25,0	63,0	8,0	10	No End Cutting	82968	83106	83029
8,0	25,0	63,0	8,0	10	End Cutting	82969	83107	83028
10,0	28,0	63,0	10,0	12	No End Cutting	82970	83108	83042
10,0	28,0	63,0	10,0	12	End Cutting	82971	83109	83041
12,0	38,0	89,0	12,0	12	No End Cutting	82972	83110	83044
12,0	38,0	89,0	12,0	12	End Cutting	82973	83111	83043

- Multi-flute design and positive geometry to shear with minimal pressure and delamination
- Unique clearance grind minimizes contact between tool diameter and workpiece eliminating friction
- Left hand flutes engineered to control the fibers within CFRP, preventing excessive fiber breakout
- Excels at trimming and profiling difficult and abrasive fiber filled plastics

Carbon Composite



20M-CCR-LHC

METRIC SERIES

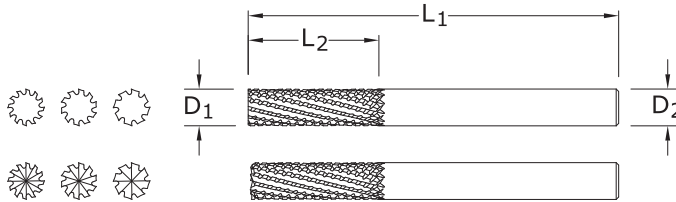

- Multi-flute design and positive geometry to shear with minimal pressure and delamination
- Unique clearance grind minimizes contact between tool diameter and workpiece eliminating friction
- Left hand flutes engineered to control the fibers within CFRP, preventing excessive fiber breakout
- Excels at trimming and profiling difficult and abrasive fiber filled plastics

CUTTING DIAMETER D ₁	LENGTH OF CUT L ₂	OVERALL LENGTH L ₁	SHANK DIAMETER D ₂	NO. OF FLUTES	END STYLE	EDP NO.	
						UNCOATED	DI-NAMITE® (Diamond)
6,0	25,0	63,0	6,0	8	No End Cutting	83220	83230
6,0	25,0	63,0	6,0	8	End Cutting	83221	83231
8,0	25,0	63,0	8,0	10	No End Cutting	83222	83232
8,0	25,0	63,0	8,0	10	End Cutting	83223	83233
10,0	28,0	63,0	10,0	12	No End Cutting	83224	83234
10,0	28,0	63,0	10,0	12	End Cutting	83225	83235

TOLERANCES (mm)

D₁ = +0,00/-0,13

D₂ = h₆

PLASTICS/COMPOSITES

For patent information visit www.ksptpatents.com

Carbon Composite

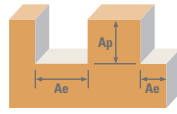

Series 20M Metric	Ae x D1	Ap x D1	Vc (m/min)	Diameter (D1) (mm)						
				3	6	8	10	12		
CFRP, AFRP (CARBON FIBER, ARAMID FIBER)	Slot 	1	≤ 1	120	RPM	12722	6361	4771	3817	3181
				(96-164)	Fr	0.055	0.113	0.243	0.366	0.439
					Feed (mm/min)	700	720	1160	1395	1395
	Profile 	≤ 0.5	≤ 1.5	150	RPM	15903	7951	5963	4771	3976
				(120-180)	Fr	0.055	0.113	0.243	0.366	0.439
					Feed (mm/min)	875	900	1450	1744	1744
	HSM 	≤ 0.05	≤ 2	250	RPM	26504	13252	9939	7951	6626
				(200-300)	Fr	0.126	0.260	0.556	0.833	1.000
					Feed (mm/min)	3350	3450	5527	6625	6625
GFRP (FIBERGLASS)	Slot 	1	≤ 1	100	RPM	10602	5301	3976	3181	2650
				(80-120)	Fr	0.054	0.111	0.236	0.357	0.428
					Feed (mm/min)	570	587	940	1135	1135
	Profile 	≤ 0.5	≤ 1.5	120	RPM	12722	6361	4771	3817	3181
				(96-164)	Fr	0.054	0.111	0.236	0.357	0.428
					Feed (mm/min)	684	704	1128	1362	1362
	HSM 	≤ 0.05	≤ 2	200	RPM	21203	10602	7951	6361	5301
				(160-240)	Fr	0.124	0.261	0.557	1.011	1.213
					Feed (mm/min)	2629	2765	4430	6430	6430
CARBON, GRAPHITE	Slot 	1	≤ 1	145	RPM	15372	7686	5765	4612	3843
				(116-174)	Fr	0.069	0.152	0.323	0.482	0.579
					Feed (mm/min)	1061	1165	1860	2224	2224
	Profile 	≤ 0.5	≤ 1.5	185	RPM	19613	9807	7355	5884	4903
				(148-222)	Fr	0.069	0.152	0.323	0.482	0.579
					Feed (mm/min)	1353	1486	2373	2838	2838
	HSM 	≤ 0.05	≤ 2	300	RPM	31805	15903	11927	9542	7951
				(240-360)	Fr	0.159	0.348	0.740	1.109	1.331
					Feed (mm/min)	5057	5535	8820	10580	10580
PLASTICS	Slot 	1	≤ 1	245	RPM	25974	12987	9740	7792	6494
				(196-294)	Fr	0.069	0.150	0.319	0.477	0.572
					Feed (mm/min)	1792	1945	3107	3717	3717
	Profile 	≤ 0.5	≤ 1.5	305	RPM	32335	16168	12126	9701	8084
				(244-366)	Fr	0.069	0.150	0.319	0.477	0.572
					Feed (mm/min)	2231	2421	3868	4627	4627
	HSM 	≤ 0.05	≤ 2	505	RPM	53538	26769	20077	16062	13385
				(404-606)	Fr	0.159	0.344	0.732	1.097	1.316
					Feed (mm/min)	8513	9220	14690	17617	17617

HSM (high speed machining)
 $rpm = (Vc \times 1000) / (D1 \times 3.14)$
 $mm/min = Fr \times rpm$
 adjust parameters based on resin type and fiber structure
 reduce speed when overheating causes melting or damage to resin
 reduce feed if delamination or fraying occur

finish cuts typically required reduced feed and cutting depths
 rates shown are for use without coolant; rates may be increased with coolant
 dust collection is vital when machining dry
 diamond coating will increase tool life in graphite and composite materials
 refer to the KYOCERA SGS Tool Wizard® for complete technical information
 (www.kyocera-sgstool.com)

Coarse Cut Carbon Composite



31-CCR FRACTIONAL SERIES

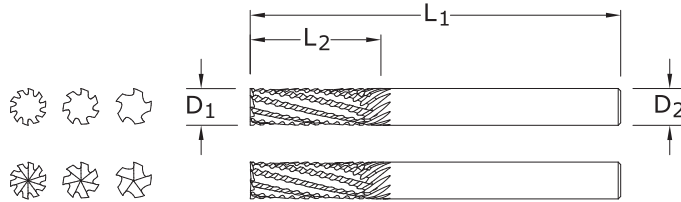

- Fewer, deeper flutes to prevent clogging in heavy routing
- Unique clearance grind minimizes contact between tool diameter and workpiece eliminating friction
- Left hand flutes engineered to control the fibers within CFRP, preventing excessive fiber breakout
- Excels at trimming and profiling difficult and abrasive fiber filled plastics

CUTTING DIAMETER D ₁	inch					EDP NO.	
	LENGTH OF CUT L ₂	OVERALL LENGTH L ₁	SHANK DIAMETER D ₂	NO. OF FLUTES	END STYLE	UNCOATED	Di-NAMITE® (Diamond)
1/4	1	2-1/2	1/4	5	End Cutting	72954	72955
1/4	1	2-1/2	1/4	5	No End Cutting	72956	72957
5/16	1	2-1/2	5/16	7	End Cutting	72958	72959
5/16	1	2-1/2	5/16	7	No End Cutting	72960	72961
3/8	1-1/8	2-1/2	3/8	8	End Cutting	72962	72963
3/8	1-1/8	2-1/2	3/8	8	No End Cutting	72964	72965
1/2	1-1/2	3-1/2	1/2	10	End Cutting	72966	72967
1/2	1-1/2	3-1/2	1/2	10	No End Cutting	72968	72969

TOLERANCES (inch)

D₁ = +.000/- .005

D₂ = h₆

PLASTICS/COMPOSITES

For patent information visit www.ksptpatents.com

Coarse Cut Carbon Composite

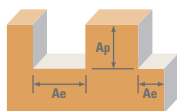

Series 31 Fractional	Material	Ae x D1	Ap x D1	Vc (sfm)	Diameter (D1) (inch)				
					1/4	5/16	3/8	1/2	
CFRP, AFRP (CARBON FIBER, ARAMID FIBER)	Slot 	1	≤ 1	400	RPM	6112	4890	4075	3056
				(320-480)	Fr	0.0029	0.0065	0.0088	0.0147
					Feed (ipm)	18	32	36	45
	Profile 	≤ 0.5	≤ 1.5	500	RPM	7640	6112	5093	3820
				(400-600)	Fr	0.0029	0.0065	0.0088	0.0147
					Feed (ipm)	23	40	45	56
	HSM 	≤ 0.05	≤ 2	825	RPM	12606	10085	8404	6303
				(660-990)	Fr	0.0069	0.0151	0.0206	0.0344
					Feed (ipm)	87	152	173	217
GFRP (FIBERGLASS)	Slot 	1	≤ 1	320	RPM	4890	3912	3260	2445
				(256-384)	Fr	0.0031	0.0066	0.0089	0.0147
					Feed (ipm)	15	26	29	36
	Profile 	≤ 0.5	≤ 1.5	400	RPM	6112	4890	4075	3056
				(320-480)	Fr	0.0031	0.0066	0.0089	0.0147
					Feed (ipm)	19	33	36	45
	HSM 	≤ 0.05	≤ 2	660	RPM	10085	8068	6723	5042
				(528-792)	Fr	0.0069	0.0150	0.0205	0.0343
					Feed (ipm)	70	121	138	173
CARBON, GRAPHITE	Slot 	1	≤ 1	480	RPM	7334	5868	4890	3667
				(384-576)	Fr	0.0040	0.0087	0.0119	0.0199
					Feed (ipm)	29	51	58	73
	Profile 	≤ 0.5	≤ 1.5	600	RPM	9168	7334	6112	4584
				(480-720)	Fr	0.0040	0.0087	0.0119	0.0199
					Feed (ipm)	36	64	73	91
	HSM 	≤ 0.05	≤ 2	990	RPM	15127	12102	10085	7564
				(792-1188)	Fr	0.0092	0.0201	0.0275	0.0459
					Feed (ipm)	139	243	277	347
PLASTICS	Slot 	1	≤ 1	800	RPM	12224	9779	8149	6112
				(640-690)	Fr	0.0040	0.0087	0.0119	0.0200
					Feed (ipm)	49	85	97	122
	Profile 	≤ 0.5	≤ 1.5	1000	RPM	15280	12224	10187	7640
				(800-1200)	Fr	0.0040	0.0087	0.0119	0.0200
					Feed (ipm)	61	106	121	153
	HSM 	≤ 0.05	≤ 2	1650	RPM	25212	20170	16808	12606
				(1320-1980)	Fr	0.0092	0.0201	0.0275	0.0459
					Feed (ipm)	232	405	462	578

HSM (high speed machining)
 $rpm = Vc \times 3.82 / D_1$
 $ipm = Fr \times rpm$
 adjust parameters based on resin type and fiber structure
 reduce speed when overheating causes melting or damage to resin
 reduce feed if delamination or fraying occur

finish cuts typically required reduced feed and cutting depths
 rates shown are for use without coolant; rates may be increased with coolant
 dust collection is vital when machining dry
 diamond coating will increase tool life in graphite and composite materials
 refer to the KYOCERA SGS Tool Wizard® for complete technical information
 (www.kyocera-sgstool.com)

Coarse Cut Carbon Composite



31M-CCR METRIC SERIES

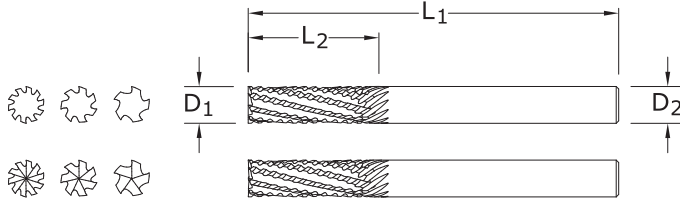

- Fewer, deeper flutes to prevent clogging in heavy routing
- Unique clearance grind minimizes contact between tool diameter and workpiece eliminating friction
- Left hand flutes engineered to control the fibers within CFRP, preventing excessive fiber breakout
- Excels at trimming and profiling difficult and abrasive fiber filled plastics

mm						EDP NO.		
CUTTING DIAMETER D ₁	LENGTH OF CUT L ₂	OVERALL LENGTH L ₁	SHANK DIAMETER D ₂	NO. OF FLUTES	END STYLE	UNCOATED	Ti-NAMITE-B (TiB ₂)	Di-NAMITE® (Diamond)
6,0	25,0	63,0	6,0	5	End Cutting	82974	83200	82982
6,0	25,0	63,0	6,0	5	No End Cutting	82975	83201	82983
8,0	25,0	63,0	8,0	7	End Cutting	82976	83202	82984
8,0	25,0	63,0	8,0	7	No End Cutting	82977	83203	82985
10,0	28,0	63,0	10,0	8	End Cutting	82978	83204	82986
10,0	28,0	63,0	10,0	8	No End Cutting	82979	83205	82987
12,0	38,0	89,0	12,0	10	End Cutting	82980	83206	82988
12,0	38,0	89,0	12,0	10	No End Cutting	82981	83207	82989

TOLERANCES (mm)

D₁ = +0,00/-0,13

D₂ = h₆

PLASTICS/COMPOSITES

For patent information visit www.ksptpatents.com

Coarse Cut Carbon Composite

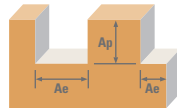

Series 31M Metric	Ae x D1	Ap x D1	Vc (m/min)	Diameter (D1) (mm)					
				6	8	10	12		
CFRP, AFRP (CARBON FIBER, ARAMID FIBER)	Slot 	1	≤ 1	120	RPM	6361	4771	3817	3181
				(96-164)	Fr	0.071	0.170	0.244	0.366
					Feed (mm/min)	450	810	930	1165
	Profile 	≤ 0.5	≤ 1.5	150	RPM	7951	5963	4771	3976
				(120-180)	Fr	0.071	0.170	0.244	0.366
					Feed (mm/min)	563	1013	1163	1456
	HSM 	≤ 0.05	≤ 2	250	RPM	13252	9939	7951	6626
				(200-300)	Fr	0.162	0.388	0.555	0.832
					Feed (mm/min)	2150	3860	4415	5515
GFRP (FIBERGLASS)	Slot 	1	≤ 1	100	RPM	5301	3976	3181	2650
				(80-120)	Fr	0.069	0.165	0.237	0.357
					Feed (mm/min)	365	655	755	945
	Profile 	≤ 0.5	≤ 1.5	120	RPM	6361	4771	3817	3181
				(96-164)	Fr	0.069	0.165	0.237	0.357
					Feed (mm/min)	438	786	906	1134
	HSM 	≤ 0.05	≤ 2	200	RPM	10602	7951	6361	5301
				(160-240)	Fr	0.163	0.390	0.557	0.834
					Feed (mm/min)	1725	3100	3540	4420
CARBON, GRAPHITE	Slot 	1	≤ 1	145	RPM	7686	5765	4612	3843
				(116-174)	Fr	0.095	0.226	0.321	0.483
					Feed (mm/min)	728	1300	1480	1855
	Profile 	≤ 0.5	≤ 1.5	185	RPM	9807	7355	5884	4903
				(148-222)	Fr	0.095	0.226	0.321	0.483
					Feed (mm/min)	929	1659	1888	2367
	HSM 	≤ 0.05	≤ 2	300	RPM	15903	11927	9542	7951
				(240-360)	Fr	0.217	0.517	0.739	1.111
					Feed (mm/min)	3450	6170	7050	8830
PLASTICS	Slot 	1	≤ 1	245	RPM	12987	9740	7792	6494
				(196-294)	Fr	0.094	0.223	0.318	0.477
					Feed (mm/min)	1215	2175	2475	3100
	Profile 	≤ 0.5	≤ 1.5	305	RPM	16168	12126	9701	8084
				(244-366)	Fr	0.094	0.223	0.318	0.477
					Feed (mm/min)	1513	2708	3081	3859
	HSM 	≤ 0.05	≤ 2	505	RPM	26769	20077	16062	13385
				(404-606)	Fr	0.215	0.512	0.731	1.098
					Feed (mm/min)	5760	10280	11745	14700

HSM (high speed machining)
 $rpm = (Vc \times 1000) / (D1 \times 3.14)$
 $mm/min = Fr \times rpm$
 adjust parameters based on resin type and fiber structure
 reduce speed when overheating causes melting or damage to resin
 reduce feed if delamination or fraying occur

finish cuts typically required reduced feed and cutting depths
 rates shown are for use without coolant; rates may be increased with coolant
 dust collection is vital when machining dry
 diamond coating will increase tool life in graphite and composite materials
 refer to the KYOCERA SGS Tool Wizard® for complete technical information
 (www.kyocera-sgstool.com)

FRACTIONAL Compression



25 FRACTIONAL SERIES

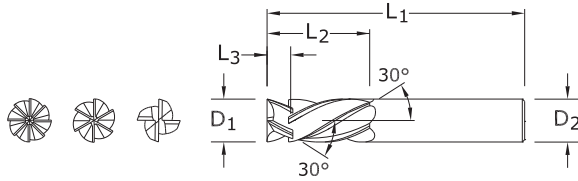

- Compression-style helixes direct cutting forces inward, eliminating fiber breakout and delamination
- Primary/secondary relief grind for reduced friction and pressure
- Rigid, heavy core

CUTTING DIAMETER D_1	LENGTH OF CUT L_2	inch				NO. OF FLUTES	EDP NO.	
		OVERALL LENGTH L_1	SHANK DIAMETER D_2	INTERSECT LENGTH L_3	UNCOATED		Di-NAMITE® (Diamond)	
1/4	1	2-1/2	1/4	11/64	4	72970	72971	
5/16	1	2-1/2	5/16	7/32	4	72972	72973	
3/8	1-1/8	2-1/2	3/8	17/64	6	72974	72975	
1/2	1-1/2	3-1/2	1/2	23/64	8	72976	72977	

TOLERANCES (inch)

$D_1 = +.000/-0.003$

$D_2 = h_6$

PLASTICS/COMPOSITES

For patent information visit www.ksptpatents.com

Compression

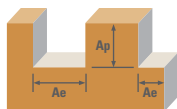

Series	25	Fractional	Ae x D ₁	Ap x D ₁	Vc (sfm)	Diameter (D ₁) (inch)			
						1/4	5/16	3/8	1/2
CFRP, AFRP (CARBON FIBER, ARAMID FIBER)	Profile	≤ 0.5	≤ 1.5	500	RPM	7640	6112	5093	3820
				(400-600)	Fz	0.0016	0.0030	0.0040	0.0048
					Feed (ipm)	49	73	122	147
	HSM	≤ 0.05	≤ 2	825	RPM	12606	10085	8404	6303
				(660-990)	Fz	0.0037	0.0069	0.0092	0.0110
					Feed (ipm)	187	278	464	555
GFRP (FIBERGLASS)	Profile	≤ 0.5	≤ 1.5	400	RPM	6112	4890	4075	3056
				(320-480)	Fz	0.0016	0.0030	0.0040	0.0048
					Feed (ipm)	39	59	98	117
	HSM	≤ 0.05	≤ 2	660	RPM	10085	8068	6723	5042
				(528-792)	Fz	0.0037	0.0069	0.0092	0.0110
					Feed (ipm)	149	223	371	444
N CARBON, GRAPHITE	Profile	≤ 0.5	≤ 1.5	600	RPM	9168	7334	6112	4584
				(480-720)	Fz	0.0020	0.0038	0.0050	0.0060
					Feed (ipm)	73	111	183	220
	HSM	≤ 0.05	≤ 2	990	RPM	15127	12102	10085	7564
				(792-1188)	Fz	0.0046	0.0086	0.0115	0.0138
					Feed (ipm)	278	416	696	835
PLASTICS	Profile	≤ 0.5	≤ 1.5	1000	RPM	15280	12224	10187	7640
				(800-1200)	Fz	0.0020	0.0038	0.0050	0.0060
					Feed (ipm)	122	186	306	367
	HSM	≤ 0.05	≤ 2	1650	RPM	25212	20170	16808	12606
				(1320-1980)	Fz	0.0046	0.0086	0.0115	0.0138
					Feed (ipm)	464	694	1160	1392
MACHINABLE CERAMICS MACHINABLE GLASS	Profile	≤ 0.5	≤ 1.5	50	RPM	764	611	509	382
				(40-60)	Fz	0.0008	0.0015	0.0020	0.0024
					Feed (ipm)	2.4	3.7	6.1	7.3
	HSM	≤ 0.05	≤ 2	85	RPM	1299	1039	866	649
				(68-102)	Fz	0.0018	0.0034	0.0046	0.0055
					Feed (ipm)	9.4	14.1	23.9	28.6

HSM (high speed machining)
 $rpm = Vc \times 3.82 / D_1$
 $ipm = Fz \times \text{number of flutes} \times rpm$
 adjust parameters based on resin type and fiber structure
 reduce speed when overheating causes melting or damage to resin
 reduce feed if delamination or fraying occur

finish cuts typically required reduced feed and cutting depths
 rates shown are for use without coolant; rates may be increased with coolant
 dust collection is vital when machining dry
 diamond coating will increase tool life in graphite and composite materials
 refer to the KYOCERA SGS Tool Wizard® for complete technical information
 (www.kyocera-sgstool.com)

Compression



25M METRIC SERIES

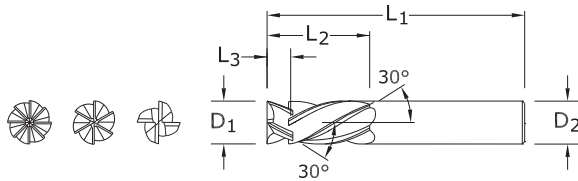

- Compression-style helixes direct cutting forces inward, eliminating fiber breakout and delamination
- Primary/secondary relief grind for reduced friction and pressure
- Rigid, heavy core

CUTTING DIAMETER D ₁	LENGTH OF CUT L ₂	mm				NO. OF FLUTES	EDP NO.	
		OVERALL LENGTH L ₁	SHANK DIAMETER D ₂	INTERSECT LENGTH L ₃	UNCOATED		Di-NAMITE® (Diamond)	
6,0	25,0	63,0	6,0	4,10	4	82990	82991	
8,0	25,0	63,0	8,0	5,58	4	82992	82993	
10,0	28,0	63,0	10,0	7,05	6	82994	82995	
12,0	38,0	89,0	12,0	8,60	8	82996	82997	

TOLERANCES (mm)

D₁ = +0,00/-0,08









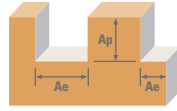

D₂ = h₆

PLASTICS/COMPOSITES

For patent information visit www.ksptpatents.com

Compression



Series 25M Metric	Ae x D ₁	Ap x D ₁	Vc (m/min)	Diameter (D ₁) (mm)					
				6	8	10	12		
CFRP, AFRP (CARBON FIBER, ARAMID FIBER)	Profile 	≤ 0.5	≤ 1.5	150	RPM	7951	5963	4771	3976
				(96-164)	Fz	0.040	0.065	0.075	0.100
				Feed (mm/min)	1272	1550	2147	3181	
	HSM 	≤ 0.05	≤ 2	250	RPM	13252	9939	7951	6626
				(200-300)	Fz	0.095	0.145	0.175	0.235
				Feed (mm/min)	5036	5765	8349	12457	
GFRP (FIBERGLASS)	Profile 	≤ 0.5	≤ 1.5	120	RPM	6361	4771	3817	3181
				(96-164)	Fz	0.040	0.065	0.075	0.100
				Feed (mm/min)	1018	1240	1717	2544	
	HSM 	≤ 0.05	≤ 2	200	RPM	10602	7951	6361	5301
				(160-240)	Fz	0.095	0.145	0.175	0.235
				Feed (mm/min)	4029	4612	6679	9966	
N CARBON, GRAPHITE	Profile 	≤ 0.5	≤ 1.5	185	RPM	9807	7355	5884	4903
				(148-222)	Fz	0.050	0.080	0.095	0.125
				Feed (mm/min)	1961	2354	3354	4903	
	HSM 	≤ 0.05	≤ 2	300	RPM	15903	11927	9542	7951
				(240-360)	Fz	0.115	0.185	0.220	0.290
				Feed (mm/min)	7315	8826	12595	18447	
PLASTICS	Profile 	≤ 0.5	≤ 1.5	305	RPM	16168	12126	9701	8084
				(244-366)	Fz	0.050	0.080	0.095	0.125
				Feed (mm/min)	3234	3880	5529	8084	
	HSM 	≤ 0.05	≤ 2	505	RPM	26769	20077	16062	13385
				(404-606)	Fz	0.115	0.185	0.220	0.290
				Feed (mm/min)	12314	14857	21201	31052	
MACHINABLE CERAMICS MACHINABLE GLASS	Profile 	≤ 0.5	≤ 1.5	15	RPM	795	596	477	398
				(12-18)	Fz	0.020	0.035	0.045	0.050
				Feed (mm/min)	64	83	129	159	
	HSM 	≤ 0.05	≤ 2	25	RPM	1325	994	795	663
				(20-30)	Fz	0.045	0.075	0.085	0.115
				Feed (mm/min)	239	298	406	610	

HSM (high speed machining)
 $rpm = (Vc \times 1000) / (D_1 \times 3.14)$
 $mm/min = Fz \times \text{number of flutes} \times rpm$
 adjust parameters based on resin type and fiber structure
 reduce speed when overheating causes melting or damage to resin
 reduce feed if delamination or fraying occur

finish cuts typically required reduced feed and cutting depths
 rates shown are for use without coolant; rates may be increased with coolant
 dust collection is vital when machining dry
 diamond coating will increase tool life in graphite and composite materials
 refer to the KYOCERA SGS Tool Wizard® for complete technical information
 (www.kyocera-sgstool.com)

FRACTIONAL Up Cut



21

FRACTIONAL SERIES

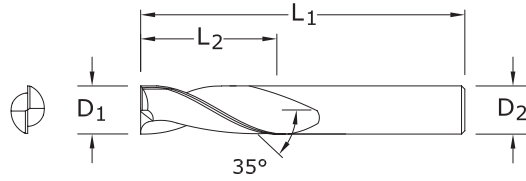

CUTTING DIAMETER D ₁	LENGTH OF CUT L ₂	OVERALL LENGTH L ₁	SHANK DIAMETER D ₂	EDP NO.
				UNCOATED
1/8	1/2	2	1/4	90001
5/32	5/8	2-1/2	1/4	90005
3/16	3/4	2-1/2	1/4	90009
1/4	3/4	2-1/2	1/4	90013
1/4	1	2-1/2	1/4	90017
5/16	1	2-1/2	5/16	90021
5/16	1	3	1/2	90025
3/8	1	2-1/2	3/8	90029
3/8	1-1/4	3	1/2	90033
1/2	1-1/4	3	1/2	90037
1/2	1-1/2	3-1/2	1/2	90041
1/2	2	4	1/2	90045
5/8	2	4-1/2	5/8	90049
3/4	2	4-1/2	3/4	90053

TOLERANCES (inch)

D₁ = +.000/- .003

D₂ = h₆

PLASTICS/COMPOSITES

For patent
information visit
www.ksptpatents.com

FRACTIONAL Down Cut

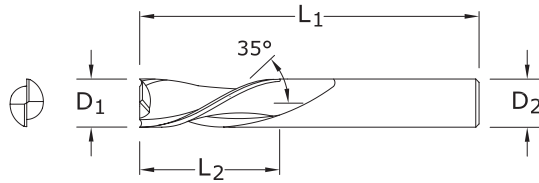

TOLERANCES (inch)

$D_1 = +.000/-0.003$

$D_2 = h_6$

PLASTICS/COMPOSITES







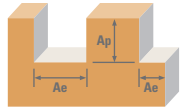

For patent
information visit
www.ksptpatents.com

22
FRACTIONAL SERIES

inch				EDP NO.
CUTTING DIAMETER D_1	LENGTH OF CUT L_2	OVERALL LENGTH L_1	SHANK DIAMETER D_2	UNCOATED
1/8	1/2	2	1/4	91001
5/32	5/8	2-1/2	1/4	91005
3/16	3/4	2-1/2	1/4	91009
1/4	3/4	2-1/2	1/4	91013
1/4	1	2-1/2	1/4	91017
5/16	1	2-1/2	5/16	91021
5/16	1	3	1/2	91025
3/8	1	2-1/2	3/8	91029
3/8	1-1/4	3	1/2	91033
1/2	1-1/4	3	1/2	91037
1/2	1-1/2	3-1/2	1/2	91041
1/2	2	4	1/2	91045
5/8	2	4-1/2	5/8	91049
3/4	2	4-1/2	3/4	91053

Up Cut Down Cut



Series 21, 22 Fractional	Ae x D ₁	Ap x D ₁	Vc (sfm)	Diameter (D ₁) (inch)						
				1/8	1/4	3/8	1/2	3/4		
HARDWOODS	Slot 	1	≤ 1	1550	RPM	47368	23684	15789	11842	7895
				(1240-1860)	Fz	0.0008	0.0015	0.0025	0.0030	0.0045
				Feed (ipm)	76	71	79	71	71	
	Profile 	≤ 0.5	≤ 1.5	1550	RPM	47368	23684	15789	11842	7895
				(1240-1860)	Fz	0.0008	0.0015	0.0025	0.0030	0.0045
				Feed (ipm)	76	71	79	71	71	
SOFTWOODS	Slot 	1	≤ 1	1950	RPM	59592	29796	19864	14898	9932
				(1560-2340)	Fz	0.0010	0.0020	0.0030	0.0035	0.0055
				Feed (ipm)	119	119	119	104	109	
	Profile 	≤ 0.5	≤ 1.5	1950	RPM	59592	29796	19864	14898	9932
				(1560-2340)	Fz	0.0010	0.0020	0.0030	0.0035	0.0055
				Feed (ipm)	119	119	119	104	109	
PLYWOODS	Slot 	1	≤ 1	1950	RPM	59592	29796	19864	14898	9932
				(1560-2340)	Fz	0.0013	0.0025	0.0040	0.0050	0.0075
				Feed (ipm)	155	149	159	149	149	
	Profile 	≤ 0.5	≤ 1.5	1950	RPM	59592	29796	19864	14898	9932
				(1560-2340)	Fz	0.0013	0.0025	0.0040	0.0050	0.0075
				Feed (ipm)	155	149	159	149	149	
N PLASTICS	Slot 	1	≤ 1	1950	RPM	59592	29796	19864	14898	9932
				(1560-2340)	Fz	0.0008	0.0017	0.0025	0.0035	0.0050
				Feed (ipm)	95	101	99	104	99	
	Profile 	≤ 0.5	≤ 1.5	1950	RPM	59592	29796	19864	14898	9932
				(1560-2340)	Fz	0.0008	0.0017	0.0025	0.0035	0.0050
				Feed (ipm)	95	101	99	104	99	

rpm = Vc x 3.82 / D₁
ipm = Fz x 2 x rpm

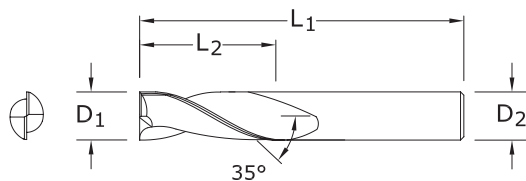
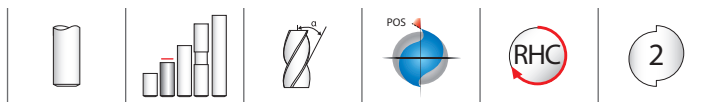

TOLERANCES (mm)

$D_1 = +0,00/-0,08$

$D_2 = h_6$

PLASTICS/COMPOSITES

For patent
information visit
www.ksptpatents.com

21M
METRIC SERIES

mm				EDP NO.
CUTTING DIAMETER D_1	LENGTH OF CUT L_2	OVERALL LENGTH L_1	SHANK DIAMETER D_2	UNCOATED
3,0	13,0	50,0	6,0	90101
4,0	16,0	63,0	6,0	90107
5,0	19,0	63,0	6,0	90109
6,0	25,0	63,0	6,0	90113
8,0	25,0	63,0	8,0	90121
10,0	31,0	75,0	10,0	90129
12,0	31,0	75,0	12,0	90137

METRIC

Down Cut



22M
METRIC SERIES

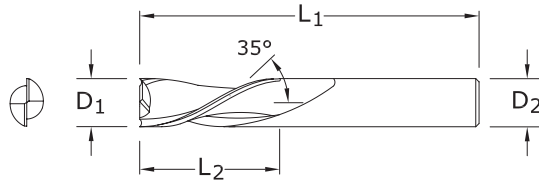

CUTTING DIAMETER D ₁	LENGTH OF CUT L ₂	OVERALL LENGTH L ₁	SHANK DIAMETER D ₂	EDP NO.
				UNCOATED
3,0	13,0	50,0	6,0	91101
4,0	16,0	63,0	6,0	91107
5,0	19,0	63,0	6,0	91109
6,0	25,0	63,0	6,0	91113
8,0	25,0	63,0	8,0	91121
10,0	31,0	75,0	10,0	91129
12,0	31,0	75,0	12,0	91137

TOLERANCES (mm)

D₁ = +0,00/-0,08

D₂ = h₆

PLASTICS/COMPOSITES

For patent information visit www.ksptpatents.com

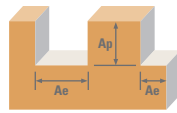

Series 21M, 22M Metric		Ae x D ₁ Ap x D ₁		Vc (m/min)	Diameter (D ₁) (mm)					
					3	6	10	12	20	
HARDWOODS	Slot 	1	≤ 1	470	RPM	49828	24914	14948	12457	7474
				(376-564)	Fz	0.020	0.040	0.065	0.075	0.115
				Feed (mm/min)	1993	1993	1943	1869	1719	
	Profile 	≤ 0.5	≤ 1.5	470	RPM	49828	24914	8155	4241	1509
				(376-564)	Fz	0.020	0.040	0.065	0.075	0.115
				Feed (mm/min)	1993	1993	1060	636	347	
SOFTWOODS	Slot 	1	≤ 1	600	RPM	63610	31805	19083	15903	9542
				(480-720)	Fz	0.025	0.050	0.075	0.090	0.140
				Feed (mm/min)	3181	3181	2862	2862	2672	
	Profile 	≤ 0.5	≤ 1.5	600	RPM	63610	31805	19083	15903	303467
				(480-720)	Fz	0.025	0.050	0.075	0.090	0.140
				Feed (mm/min)	3181	3181	2862	2862	84971	
PLYWOODS	Slot 	1	≤ 1	600	RPM	63610	31805	19083	15903	9542
				(480-720)	Fz	0.030	0.065	0.100	0.125	0.190
				Feed (mm/min)	3817	4135	3817	3976	3626	
	Profile 	≤ 0.5	≤ 1.5	600	RPM	63610	31805	19083	15903	303467
				(480-720)	Fz	0.030	0.065	0.100	0.125	0.190
				Feed (mm/min)	3817	4135	3817	3976	115318	
N PLASTICS	Slot 	1	≤ 1	600	RPM	63610	31805	19083	15903	9542
				(480-720)	Fz	0.020	0.040	0.065	0.090	0.125
				Feed (mm/min)	2544	2544	2481	2862	2385	
	Profile 	≤ 0.5	≤ 1.5	600	RPM	63610	31805	19083	15903	9542
				(480-720)	Fz	0.020	0.040	0.065	0.090	0.125
				Feed (mm/min)	2544	2544	2481	2862	2385	

rpm = (Vc x 1000) / (D₁ x 3.14)
mm/min = Fz x 2 x rpm

EDP Number Index

EDP NO.	PAGE	EDP NO.	PAGE	EDP NO.	PAGE	EDP NO.	PAGE	EDP NO.	PAGE	EDP NO.	PAGE	EDP NO.	PAGE
30000	193	30111	193	30192	193	30375	180	30495	185	30578	189	30833	188
30001	193	30112	198	30193	193	30376	185	30496	185	30589	211	30834	188
30002	193	30113	193	30194	193	30377	179	30497	185	30590	189	30835	188
30003	193	30114	198	30195	193	30378	184	30498	185	30590	212	30836	188
30004	193	30115	193	30196	193	30379	194	30499	185	30591	185	30837	188
30005	193	30116	198	30197	193	30380	194	30500	185	30592	185	30838	188
30006	193	30117	193	30198	193	30381	194	30501	188	30593	185	30839	188
30007	193	30118	198	30199	193	30382	194	30502	189	30594	185	30840	188
30008	193	30119	193	30300	193	30383	194	30503	188	30595	185	30841	188
30009	193	30120	198	30301	179	30384	199	30504	189	30596	185	30842	188
30010	193	30121	193	30302	184	30385	199	30505	188	30597	185	30843	188
30011	193	30122	198	30303	179	30386	199	30506	189	30598	185	30844	188
30012	194	30123	193	30304	184	30387	199	30507	188	30599	184	30845	188
30013	194	30124	198	30305	179	30388	199	30508	189	30600	185	30846	188
30014	194	30125	193	30306	184	30389	180	30509	188	30600	212	30847	188
30015	194	30126	198	30307	179	30389	211	30510	189	30602	189	30848	188
30016	194	30127	193	30308	184	30390	185	30511	188	30604	189	30849	188
30017	194	30128	198	30309	179	30390	212	30512	189	30606	189	30850	211
30018	194	30129	193	30310	184	30397	179	30513	188	30608	189	30851	189
30019	194	30130	198	30311	179	30398	179	30514	189	30610	189	30852	189
30020	194	30131	193	30312	184	30399	179	30515	188	30612	189	30853	189
30021	194	30132	198	30313	179	30400	179	30516	189	30771	188	30854	189
30022	194	30133	193	30314	184	30435	179	30517	188	30772	188	30855	189
30023	194	30134	198	30315	179	30436	179	30518	189	30773	188	30856	189
30024	194	30135	193	30316	184	30437	179	30519	188	30774	188	30857	189
30025	194	30136	198	30317	179	30438	179	30520	189	30775	188	30858	189
30026	194	30137	193	30318	184	30439	179	30521	188	30776	188	30859	189
30027	194	30138	198	30319	179	30440	179	30522	189	30777	188	30860	189
30028	194	30139	193	30320	184	30441	179	30523	188	30778	188	30861	189
30029	193	30140	198	30321	179	30442	179	30524	189	30779	188	30862	189
30030	194	30141	193	30322	184	30443	179	30525	188	30780	188	30863	189
30030	211	30142	198	30323	179	30444	179	30526	189	30781	188	30864	189
30031	198	30143	194	30324	184	30445	179	30527	188	30782	188	30865	189
30032	198	30144	199	30325	179	30446	179	30528	189	30783	188	30866	189
30033	198	30145	194	30326	184	30447	179	30529	188	30784	188	30867	189
30034	198	30146	199	30327	179	30448	179	30530	189	30785	188	30868	189
30035	198	30147	194	30328	184	30449	179	30531	188	30786	188	30869	189
30036	198	30148	199	30329	179	30450	179	30532	189	30787	188	30870	189
30037	198	30149	194	30330	184	30451	179	30533	188	30788	188	30871	189
30038	198	30150	199	30331	179	30452	179	30534	189	30789	188	30872	189
30039	198	30151	194	30332	184	30453	179	30535	188	30790	188	30873	189
30040	198	30152	199	30333	179	30454	179	30536	189	30791	188	30874	189
30041	198	30153	194	30334	184	30455	180	30537	189	30792	188	30875	189
30042	198	30154	199	30335	179	30456	180	30538	188	30793	188	30876	189
30043	198	30155	194	30336	184	30457	180	30539	188	30794	188	30877	189
30044	198	30156	199	30337	179	30458	180	30540	189	30795	188	30878	189
30045	198	30157	194	30338	184	30459	180	30541	188	30796	188	30879	189
30046	198	30158	199	30339	179	30460	180	30542	189	30797	188	30880	189
30047	198	30159	194	30340	184	30461	180	30543	188	30798	188	30881	189
30048	198	30160	199	30341	179	30462	180	30544	189	30799	188	30882	189
30049	198	30161	194	30342	184	30463	180	30545	188	30800	188	30883	189
30050	198	30162	199	30343	179	30464	180	30546	189	30801	188	30884	189
30051	198	30163	194	30344	185	30465	180	30547	188	30802	188	30885	189
30052	199	30164	199	30345	179	30466	180	30548	189	30803	188	30886	189
30053	199	30165	194	30346	185	30467	180	30549	188	30804	188	30887	189
30054	199	30166	199	30347	179	30468	180	30550	189	30805	188	30888	189
30055	199	30167	194	30348	185	30469	179	30551	188	30806	188	30889	189
30056	199	30168	199	30349	180	30470	180	30552	189	30807	188	30900	189
30057	199	30169	194	30350	185	30470	211	30553	188	30808	188	30900	212
30058	199	30170	199	30351	180	30471	184	30554	189	30809	188	30902	189
30059	199	30171	194	30352	185	30472	184	30555	188	30810	211	30904	189
30060	199	30172	199	30353	180	30473	184	30556	188	30811	188	30906	189
30061	199	30173	194	30354	185	30474	184	30557	189	30812	188	30908	189
30062	199	30174	199	30355	180	30475	184	30558	189	30813	188	30910	189
30063	199	30175	194	30356	185	30476	184	30559	188	30814	188	30912	189
30064	199	30176	199	30357	180	30477	184	30560	189	30815	188	30914	189
30065	199	30177	193	30358	185	30478	184	30561	188	30816	188	30916	189
30066	199	30178	198	30359	180	30479	184	30562	189	30817	188	30918	189
30067	199	30179	194	30360	185	30480	184	30563	188	30818	188	30920	189
30068	199	30180	194	30361	180	30481	184	30564	189	30819	188	30921	189
30069	198	30181	194	30362	185	30482	184	30565	188	30820	188	30922	189
30070	199	30182	194	30363	180	30483	184	30566	189	30821	188	30923	189
30070	212	30183	194	30364	185	30484	184	30567	188	30822	188	30924	189
30101	193	30184	199	30365	180	30485	184	30568	189	30823	188	30925	189
30102	198	30185	199	30366	185	30486	184	30569	188	30824	188	30926	189
30103	193	30186	199	30367	180	30487	184	30570	189	30825	188	30927	189
30104	198	30187	199	30368	185	30488	184	30571	188	30826	188	30928	189
30105	193	30188	199	30369	180	30489	184	30572	189	30827	188	30929	189
30106	198	30189	194	30370	185	30490	184	30573	188	30828	188	30930	189
30107	193	30189	211	30371	180	30491	184	30574	189	30829	188	30931	189
30108	198	30190	199	30372	185	30492	185	30575	188	30830	188	30932	189
30109	193	30190	212	30373	180	30493	185	30576	189	30831	188	30933	189
30110	198	30191	193	30374	185	30494	185	30577	188	30832	188	30934	189

EDP Number Index

EDP NO.	PAGE	EDP NO.	PAGE	EDP NO.	PAGE	EDP NO.	PAGE	EDP NO.	PAGE	EDP NO.	PAGE	EDP NO.	PAGE
35137	77	35506	209	35648	137	35741	137	36238	141	36448	38	36605	37
35138	77	35507	209	35649	137	35742	137	36239	139	36449	38	36610	37
35139	77	35508	209	35650	137	35743	137	36240	139	36450	38	36611	37
35140	77	35509	209	35651	137	35744	137	36241	141	36452	38	36612	37
35141	77	35510	209	35652	137	35787	139	36242	141	36453	38	36613	37
35150	75	35511	209	35653	137	35788	139	36243	139	36454	38	36614	37
35151	75	35512	209	35654	137	35789	141	36244	139	36456	38	36615	37
35152	75	35513	209	35665	135	35790	141	36245	141	36457	38	36616	56
35153	75	35514	209	35666	135	35791	139	36246	141	36458	38	36617	56
35154	75	35515	209	35667	135	35792	139	36247	141	36460	38	36618	56
35155	75	35575	135	35668	135	35793	141	36248	141	36462	38	36620	86
35156	75	35576	135	35669	135	35794	141	36249	141	36463	38	36621	86
35157	75	35577	135	35670	135	35795	139	36250	141	36464	38	36622	86
35158	75	35578	135	35671	135	35796	139	36251	140	36466	38	36623	86
35159	75	35579	135	35672	135	35797	141	36252	140	36468	38	36624	86
35160	75	35580	135	35673	135	35798	141	36253	141	36469	38	36625	86
35161	75	35581	135	35674	135	35799	141	36254	141	36470	38	36626	86
35180	77	35582	135	35675	135	35800	141	36257	140	36472	38	36627	86
35181	77	35583	135	35676	135	35801	141	36258	140	36474	38	36628	86
35182	77	35584	135	35677	135	35802	141	36259	140	36475	38	36629	86
35183	77	35585	135	35678	135	35803	140	36260	140	36480	39	36630	86
35184	77	35586	135	35679	135	35804	140	36261	141	36482	39	36631	86
35185	77	35587	135	35680	135	35805	141	36262	141	36486	39	36632	86
35186	77	35588	135	35681	135	35806	141	36263	141	36500	39	36633	86
35187	77	35589	135	35682	135	35809	140	36264	141	36502	39	36634	86
35188	77	35590	135	35683	135	35810	140	36265	141	36504	39	36635	86
35189	77	35591	135	35684	135	35811	140	36266	141	36505	48	36636	86
35190	77	35592	135	35685	135	35812	140	36344	49	36506	48	36637	86
35191	77	35593	135	35686	135	35813	141	36345	49	36507	48	36638	86
35273	208	35594	135	35687	135	35814	141	36346	49	36508	48	36639	86
35275	208	35595	135	35688	135	35815	141	36347	49	36509	48	36640	86
35277	208	35596	135	35689	135	35816	141	36348	49	36511	48	36641	86
35278	208	35597	135	35690	135	35817	141	36349	49	36513	48	36701	36
35279	208	35598	135	35691	135	35818	141	36350	49	36515	48	36702	36
35280	208	35599	135	35692	135	36106	206	36351	49	36517	48	36704	37
35281	208	35600	135	35693	136	36107	206	36352	49	36519	48	36706	37
35282	208	35601	135	35694	136	36108	206	36353	49	36520	48	36707	37
35283	208	35602	135	35695	136	36109	206	36354	49	36530	47	36709	37
35285	208	35603	136	35696	136	36110	206	36355	49	36531	47	36710	37
35287	208	35604	136	35697	136	36111	206	36356	49	36532	47	36711	37
35289	208	35605	136	35698	136	36112	206	36357	49	36533	47	36712	37
35291	208	35606	136	35699	136	36113	206	36358	49	36534	47	36713	37
35293	208	35607	136	35700	136	36114	206	36359	49	36535	47	36714	37
35295	208	35608	136	35701	136	36116	206	36361	49	36536	47	36715	37
35297	208	35609	136	35702	136	36117	206	36370	36	36537	47	36716	37
35300	208	35610	136	35703	136	36118	206	36371	36	36538	47	36717	37
35301	208	35611	136	35704	136	36120	206	36372	36	36539	49	36718	37
35302	208	35612	136	35705	136	36121	206	36373	36	36540	49	36719	37
35303	208	35613	136	35706	136	36122	206	36374	36	36541	49	36722	36
35304	208	35614	136	35707	136	36124	206	36375	36	36542	49	36723	36
35305	208	35615	136	35708	136	36125	206	36376	36	36543	49	36724	36
35306	208	35616	136	35709	136	36126	206	36378	37	36544	49	36725	36
35307	208	35617	136	35710	136	36128	206	36380	37	36545	49	36727	36
35308	208	35618	136	35711	136	36129	206	36381	37	36546	49	36729	37
35309	208	35619	136	35712	136	36130	206	36383	37	36547	49	36731	37
35310	208	35620	136	35713	136	36140	110	36384	37	36555	56	36733	37
35311	208	35621	136	35714	136	36141	110	36385	37	36556	56	36736	36
35312	208	35622	136	35715	136	36142	110	36386	37	36557	56	36738	36
35313	208	35623	136	35716	136	36143	110	36387	37	36558	56	36740	37
35314	208	35624	136	35717	136	36206	204	36388	37	36559	56	36742	37
35315	208	35625	136	35718	136	36207	204	36389	37	36560	56	36744	37
35473	209	35626	136	35719	136	36208	204	36390	37	36561	56	36780	60
35475	209	35627	136	35720	136	36209	204	36391	37	36570	56	36781	60
35477	209	35628	136	35721	137	36210	204	36392	37	36571	56	36782	60
35478	209	35629	136	35722	137	36211	204	36393	37	36572	56	36783	60
35479	209	35630	136	35723	137	36212	204	36404	47	36573	56	36784	60
35480	209	35631	137	35724	137	36213	204	36406	47	36574	56	36785	60
35481	209	35632	137	35725	137	36214	204	36408	47	36575	56	36786	60
35482	209	35633	137	35726	137	36216	204	36410	47	36576	56	36787	60
35483	209	35634	137	35727	137	36217	204	36416	47	36577	56	36788	60
35485	209	35635	137	35728	137	36218	204	36418	47	36578	56	36789	60
35487	209	35636	137	35729	137	36220	204	36420	47	36590	49	36790	60
35489	209	35637	137	35730	137	36221	204	36422	47	36591	49	36791	60
35491	209	35638	137	35731	137	36222	204	36424	47	36592	49	36792	60
35493	209	35639	137	35732	137	36224	204	36426	47	36596	47	36793	60
35495	209	35640	137	35733	137	36225	204	36428	47	36597	47	36804	37
35497	209	35641	137	35734	137	36226	204	36430	47	36598	47	36805	37
35500	209	35642	137	35735	137	36228	204	36432	47	36599	36	36806	37
35501	209	35643	137	35736	137	36229	204	36436	47	36600	36	36807	37
35502	209	35644	137	35737	137	36230	204	36440	47	36601	36	36808	37
35503	209	35645	137	35738	137	36235	139	36442	47	36602	37	36809	37
35504	209	35646	137	35739	137	36236	139	36444	47	36603	37	36810	37
35505	209	35647	137	35740	137	36237	141	36447	38	36604	37	36811	37

EDP Number Index

EDP NO.	PAGE	EDP NO.	PAGE	EDP NO.	PAGE	EDP NO.	PAGE	EDP NO.	PAGE	EDP NO.	PAGE	EDP NO.	PAGE
36812.....	37	37031.....	29	37114.....	30	37206.....	28	37343.....	29	38096.....	196	38179.....	195
36813.....	37	37032.....	29	37115.....	30	37207.....	30	37344.....	29	38097.....	196	38180.....	195
36814.....	37	37033.....	29	37116.....	28	37208.....	30	37345.....	29	38098.....	196	38181.....	195
36815.....	37	37034.....	29	37117.....	30	37209.....	30	37346.....	29	38099.....	196	38182.....	195
36816.....	37	37035.....	29	37118.....	30	37210.....	28	37348.....	29	38100.....	196	38183.....	195
36817.....	37	37036.....	28	37119.....	30	37211.....	30	37349.....	29	38101.....	196	38184.....	195
36818.....	37	37037.....	29	37120.....	30	37212.....	30	37350.....	29	38102.....	196	38185.....	195
36819.....	37	37038.....	29	37121.....	30	37213.....	30	37351.....	29	38103.....	196	38186.....	195
36820.....	37	37039.....	29	37122.....	30	37214.....	28	37352.....	29	38104.....	196	38187.....	196
36821.....	37	37040.....	29	37123.....	28	37215.....	30	37353.....	29	38105.....	196	38188.....	196
36822.....	37	37041.....	29	37124.....	30	37216.....	30	37354.....	29	38106.....	196	38189.....	196
36823.....	37	37042.....	28	37125.....	30	37217.....	30	37355.....	29	38107.....	196	38190.....	196
36824.....	37	37043.....	29	37126.....	30	37218.....	28	37356.....	29	38108.....	196	38191.....	196
36825.....	37	37044.....	29	37127.....	30	37219.....	30	37357.....	29	38109.....	196	38192.....	196
36826.....	47	37045.....	29	37128.....	30	37220.....	30	37359.....	29	38110.....	196	38193.....	196
36827.....	47	37046.....	29	37129.....	30	37221.....	30	37360.....	29	38111.....	196	38194.....	196
36828.....	47	37047.....	29	37130.....	28	37260.....	28	37361.....	29	38112.....	196	38195.....	196
36829.....	47	37048.....	28	37131.....	30	37261.....	29	37362.....	29	38113.....	196	38196.....	196
36830.....	47	37049.....	29	37132.....	30	37262.....	29	38001.....	195	38114.....	196	38197.....	196
36846.....	49	37050.....	29	37133.....	30	37263.....	29	38002.....	195	38115.....	195	38198.....	196
36847.....	49	37051.....	29	37134.....	30	37264.....	29	38003.....	195	38116.....	195	38201.....	182
36848.....	49	37052.....	29	37135.....	30	37265.....	29	38004.....	195	38117.....	195	38202.....	182
36849.....	49	37053.....	29	37136.....	30	37266.....	30	38009.....	195	38118.....	195	38203.....	182
36850.....	49	37054.....	28	37137.....	28	37267.....	28	38010.....	195	38119.....	195	38204.....	182
36851.....	36	37055.....	29	37138.....	30	37268.....	30	38011.....	195	38120.....	195	38209.....	182
36852.....	36	37056.....	29	37139.....	30	37269.....	30	38012.....	195	38121.....	195	38210.....	182
36853.....	36	37057.....	29	37140.....	30	37270.....	30	38013.....	195	38122.....	195	38211.....	182
36854.....	36	37058.....	29	37141.....	30	37271.....	30	38014.....	195	38123.....	195	38212.....	182
36855.....	36	37059.....	29	37142.....	30	37272.....	30	38019.....	195	38124.....	195	38213.....	182
36856.....	36	37060.....	28	37143.....	30	37273.....	30	38020.....	195	38125.....	195	38214.....	182
36857.....	37	37061.....	29	37144.....	28	37274.....	28	38021.....	195	38126.....	195	38219.....	182
36858.....	37	37062.....	29	37145.....	30	37275.....	30	38022.....	195	38127.....	195	38220.....	182
36859.....	37	37063.....	29	37146.....	30	37276.....	30	38023.....	195	38128.....	195	38221.....	182
36860.....	37	37064.....	29	37147.....	30	37277.....	30	38024.....	195	38129.....	195	38222.....	182
36861.....	37	37065.....	29	37148.....	30	37278.....	30	38025.....	195	38130.....	195	38223.....	182
36862.....	37	37066.....	30	37149.....	30	37279.....	30	38026.....	195	38131.....	195	38224.....	182
36863.....	37	37067.....	28	37150.....	30	37280.....	30	38031.....	195	38132.....	195	38225.....	182
36864.....	36	37068.....	29	37151.....	28	37281.....	28	38032.....	195	38133.....	195	38226.....	182
36865.....	37	37069.....	29	37152.....	30	37282.....	30	38033.....	195	38134.....	195	38231.....	182
36866.....	37	37070.....	29	37153.....	30	37283.....	30	38034.....	195	38135.....	195	38232.....	182
36867.....	37	37071.....	29	37154.....	30	37284.....	30	38035.....	195	38136.....	195	38233.....	182
36868.....	37	37072.....	29	37155.....	30	37285.....	30	38036.....	195	38137.....	195	38234.....	182
36869.....	37	37073.....	30	37156.....	30	37286.....	30	38037.....	195	38138.....	195	38235.....	182
36870.....	37	37074.....	28	37157.....	30	37287.....	30	38038.....	195	38139.....	195	38236.....	182
36871.....	37	37075.....	30	37159.....	28	37288.....	28	38045.....	195	38140.....	195	38237.....	182
36872.....	36	37076.....	30	37160.....	29	37289.....	30	38046.....	195	38141.....	195	38238.....	182
36873.....	36	37077.....	30	37161.....	29	37290.....	30	38047.....	195	38142.....	195	38245.....	182
36874.....	36	37078.....	30	37162.....	29	37291.....	30	38048.....	195	38143.....	195	38246.....	182
36875.....	36	37079.....	30	37163.....	29	37292.....	30	38049.....	195	38144.....	195	38247.....	182
36876.....	36	37080.....	30	37164.....	29	37293.....	30	38050.....	195	38145.....	196	38248.....	182
36877.....	36	37081.....	28	37165.....	29	37294.....	30	38051.....	195	38146.....	196	38249.....	182
36878.....	36	37082.....	30	37166.....	29	37295.....	28	38052.....	195	38147.....	196	38250.....	182
37000.....	28	37083.....	30	37167.....	29	37296.....	30	38059.....	195	38148.....	196	38251.....	182
37001.....	29	37084.....	30	37168.....	28	37297.....	30	38060.....	195	38149.....	196	38252.....	182
37002.....	28	37085.....	30	37169.....	28	37298.....	30	38061.....	195	38150.....	196	38259.....	182
37003.....	29	37086.....	30	37170.....	28	37299.....	30	38062.....	195	38151.....	196	38260.....	182
37004.....	28	37087.....	30	37175.....	29	37300.....	30	38063.....	195	38152.....	196	38261.....	182
37005.....	29	37088.....	28	37180.....	28	37301.....	30	38064.....	195	38153.....	196	38262.....	182
37006.....	28	37089.....	30	37181.....	29	37302.....	28	38065.....	195	38154.....	196	38263.....	182
37007.....	29	37090.....	30	37182.....	28	37303.....	30	38066.....	195	38155.....	196	38264.....	182
37008.....	28	37091.....	30	37183.....	29	37304.....	30	38067.....	195	38156.....	196	38265.....	182
37009.....	29	37092.....	30	37184.....	28	37305.....	30	38068.....	195	38157.....	195	38266.....	182
37010.....	29	37093.....	30	37185.....	29	37306.....	30	38073.....	195	38158.....	195	38267.....	182
37011.....	28	37094.....	30	37186.....	29	37307.....	30	38074.....	195	38159.....	195	38268.....	182
37012.....	29	37095.....	28	37187.....	28	37308.....	30	38075.....	195	38160.....	195	38273.....	182
37013.....	29	37096.....	30	37188.....	29	37320.....	28	38076.....	195	38161.....	195	38274.....	182
37014.....	28	37097.....	30	37189.....	29	37321.....	28	38077.....	195	38162.....	195	38275.....	182
37015.....	29	37098.....	30	37190.....	28	37322.....	28	38078.....	195	38163.....	195	38276.....	182
37016.....	28	37099.....	30	37191.....	29	37323.....	28	38079.....	195	38164.....	195	38277.....	182
37017.....	29	37100.....	30	37192.....	29	37324.....	28	38080.....	195	38165.....	195	38278.....	182
37018.....	28	37101.....	30	37193.....	29	37325.....	28	38081.....	195	38166.....	195	38279.....	182
37019.....	29	37102.....	28	37194.....	29	37330.....	29	38082.....	195	38167.....	195	38280.....	182
37020.....	29	37103.....	30	37195.....	29	37331.....	29	38083.....	195	38168.....	195	38281.....	182
37021.....	28	37104.....	30	37196.....	29	37332.....	29	38084.....	195	38169.....	195	38282.....	182
37022.....	29	37105.....	30	37197.....	29	37333.....	29	38087.....	195	38170.....	195	38283.....	182
37023.....	29	37106.....	30	37198.....	28	37334.....	29	38088.....	195	38171.....	195	38284.....	182
37024.....	28	37107.....	30	37199.....	30	37335.....	29	38089.....	195	38172.....	195	38287.....	182
37025.....	29	37108.....	30	37200.....	30	37337.....	29	38090.....	195	38173.....	195	38288.....	182
37026.....	29	37109.....	28	37201.....	30	37338.....	29	38091.....	196	38174.....	195	38289.....	182
37027.....	29	37110.....	30	37202.....	28	37339.....	29	38092.....	196	38175.....	195	38290.....	182
37028.....	29	37111.....	30	37203.....	30	37340.....	29	38093.....	196	38176.....	195	38291.....	182
37029.....	29	37112.....	30	37204.....	30	37341.....	29	38094.....	196	38177.....	195	38292.....	182
37030.....	28	37113.....	30	37205.....	30	37342.....	29	38095.....	196	38178.....	195	38293.....	182

EDP Number Index

EDP NO.	PAGE	EDP NO.	PAGE	EDP NO.	PAGE	EDP NO.	PAGE	EDP NO.	PAGE	EDP NO.	PAGE	EDP NO.	PAGE
38294.....	182	38377.....	182	39031.....	193	39131.....	193	39333.....	179	39534.....	184	39635.....	197
38295.....	182	38378.....	182	39032.....	198	39132.....	198	39334.....	184	39535.....	179	39636.....	200
38296.....	182	38379.....	182	39033.....	193	39133.....	193	39335.....	179	39536.....	184	39637.....	197
38297.....	182	38380.....	182	39034.....	198	39134.....	198	39336.....	184	39537.....	179	39638.....	200
38298.....	182	38381.....	182	39035.....	193	39135.....	193	39337.....	179	39538.....	184	39639.....	197
38299.....	182	38382.....	182	39036.....	198	39136.....	198	39338.....	184	39539.....	179	39640.....	200
38300.....	182	38383.....	182	39037.....	193	39137.....	193	39339.....	179	39540.....	184	39641.....	197
38301.....	182	38384.....	182	39038.....	198	39138.....	198	39340.....	184	39541.....	179	39642.....	200
38302.....	182	38385.....	182	39039.....	193	39139.....	193	39341.....	179	39542.....	184	39642.....	200
38303.....	182	38386.....	182	39040.....	198	39140.....	198	39342.....	184	39543.....	179	39642.....	212
38304.....	182	38387.....	182	39041.....	193	39141.....	193	39343.....	179	39544.....	185	39651.....	183
38305.....	182	38388.....	182	39042.....	198	39142.....	198	39344.....	185	39545.....	179	39652.....	187
38306.....	182	38389.....	182	39043.....	194	39143.....	194	39345.....	179	39546.....	185	39653.....	183
38307.....	182	38390.....	182	39044.....	199	39144.....	199	39346.....	185	39547.....	179	39654.....	187
38308.....	182	38391.....	182	39045.....	194	39145.....	194	39347.....	179	39548.....	185	39655.....	183
38309.....	182	38392.....	182	39046.....	199	39146.....	199	39348.....	185	39549.....	180	39656.....	187
38310.....	182	38393.....	182	39047.....	194	39147.....	194	39349.....	180	39550.....	185	39657.....	183
38311.....	182	38394.....	182	39048.....	199	39148.....	199	39350.....	185	39551.....	180	39658.....	187
38312.....	182	38395.....	182	39049.....	194	39149.....	194	39351.....	180	39552.....	185	39659.....	183
38313.....	182	38396.....	182	39050.....	199	39150.....	199	39352.....	185	39553.....	180	39660.....	187
38314.....	182	38397.....	182	39051.....	194	39151.....	194	39353.....	185	39554.....	185	39661.....	183
38315.....	182	38398.....	182	39052.....	199	39152.....	199	39354.....	180	39555.....	180	39662.....	187
38316.....	182	38490.....	39	39053.....	194	39153.....	194	39355.....	180	39556.....	185	39663.....	183
38317.....	182	38492.....	39	39054.....	199	39154.....	199	39356.....	185	39557.....	180	39664.....	187
38318.....	182	38496.....	39	39055.....	194	39155.....	194	39357.....	180	39558.....	185	39665.....	183
38319.....	182	38502.....	28	39056.....	199	39156.....	199	39358.....	185	39559.....	180	39666.....	187
38320.....	182	38504.....	28	39057.....	194	39157.....	194	39359.....	180	39560.....	185	39667.....	183
38321.....	182	38506.....	28	39058.....	199	39158.....	199	39360.....	185	39561.....	180	39668.....	187
38322.....	182	38507.....	28	39059.....	194	39159.....	194	39361.....	180	39562.....	185	39669.....	183
38323.....	182	38508.....	28	39060.....	199	39160.....	199	39362.....	185	39563.....	180	39670.....	187
38324.....	182	38512.....	28	39061.....	194	39161.....	194	39363.....	180	39564.....	185	39671.....	183
38325.....	182	38513.....	28	39062.....	199	39162.....	199	39364.....	185	39565.....	180	39672.....	187
38326.....	182	38514.....	28	39063.....	194	39163.....	194	39365.....	180	39566.....	185	39673.....	183
38327.....	182	38515.....	28	39064.....	199	39164.....	199	39366.....	185	39567.....	180	39674.....	187
38328.....	182	38517.....	28	39065.....	194	39165.....	194	39367.....	180	39568.....	185	39675.....	183
38329.....	182	38525.....	29	39066.....	199	39166.....	199	39368.....	185	39569.....	180	39676.....	187
38330.....	182	38528.....	29	39067.....	194	39167.....	194	39369.....	180	39570.....	185	39677.....	183
38331.....	182	38529.....	29	39068.....	199	39168.....	199	39370.....	185	39571.....	180	39678.....	187
38332.....	182	38530.....	29	39069.....	194	39169.....	194	39371.....	180	39572.....	185	39679.....	183
38333.....	182	38532.....	29	39070.....	199	39170.....	199	39372.....	185	39573.....	180	39680.....	187
38334.....	182	38539.....	29	39071.....	194	39171.....	194	39373.....	180	39574.....	185	39681.....	183
38335.....	182	38549.....	29	39072.....	199	39172.....	199	39374.....	185	39575.....	180	39682.....	187
38336.....	182	38578.....	29	39073.....	194	39173.....	194	39375.....	185	39576.....	185	39683.....	183
38337.....	182	38579.....	29	39074.....	199	39174.....	199	39376.....	180	39577.....	179	39684.....	187
38338.....	182	38580.....	29	39075.....	194	39175.....	194	39377.....	179	39578.....	184	39685.....	183
38339.....	182	38581.....	29	39076.....	199	39176.....	199	39378.....	184	39589.....	180	39686.....	187
38340.....	182	38583.....	29	39077.....	193	39177.....	193	39389.....	180	39589.....	211	39687.....	183
38341.....	182	38584.....	29	39078.....	198	39178.....	198	39389.....	211	39590.....	185	39688.....	187
38342.....	182	38585.....	29	39089.....	194	39189.....	194	39390.....	185	39590.....	212	39689.....	183
38343.....	182	38591.....	29	39089.....	211	39189.....	211	39390.....	212	39601.....	197	39690.....	187
38344.....	182	38599.....	30	39090.....	199	39190.....	199	39501.....	179	39602.....	200	39691.....	183
38345.....	182	38608.....	30	39090.....	212	39301.....	179	39502.....	184	39603.....	197	39691.....	211
38346.....	182	38617.....	30	39101.....	193	39302.....	184	39503.....	179	39604.....	200	39692.....	187
38347.....	182	39001.....	193	39102.....	198	39303.....	179	39504.....	184	39605.....	197	39692.....	212
38348.....	182	39002.....	198	39103.....	193	39304.....	184	39505.....	179	39606.....	200	39701.....	188
38349.....	182	39003.....	193	39104.....	198	39305.....	179	39506.....	184	39607.....	197	39703.....	188
38350.....	182	39004.....	198	39105.....	193	39306.....	184	39507.....	179	39608.....	200	39705.....	188
38351.....	182	39005.....	193	39106.....	198	39307.....	179	39508.....	184	39609.....	197	39707.....	188
38352.....	182	39006.....	198	39107.....	193	39308.....	184	39509.....	179	39610.....	200	39709.....	188
38353.....	182	39007.....	193	39108.....	198	39309.....	179	39510.....	184	39611.....	197	39711.....	188
38354.....	182	39008.....	198	39109.....	193	39310.....	184	39511.....	179	39612.....	200	39713.....	188
38355.....	182	39009.....	193	39109.....	212	39311.....	179	39512.....	184	39613.....	197	39715.....	188
38356.....	182	39010.....	198	39110.....	198	39312.....	184	39513.....	179	39614.....	200	39717.....	188
38357.....	182	39011.....	193	39111.....	193	39313.....	179	39514.....	184	39615.....	197	39719.....	188
38358.....	182	39012.....	198	39112.....	198	39314.....	184	39515.....	179	39616.....	200	39721.....	188
38359.....	182	39013.....	193	39113.....	193	39315.....	179	39516.....	184	39617.....	197	39723.....	188
38360.....	182	39014.....	198	39114.....	198	39316.....	184	39517.....	179	39618.....	200	39725.....	188
38361.....	182	39015.....	193	39115.....	193	39317.....	179	39518.....	184	39619.....	197	39727.....	188
38362.....	182	39016.....	198	39116.....	198	39318.....	184	39519.....	179	39620.....	200	39729.....	188
38363.....	182	39017.....	193	39117.....	193	39319.....	179	39520.....	184	39621.....	197	39731.....	188
38364.....	182	39018.....	198	39118.....	198	39320.....	184	39521.....	179	39622.....	200	39733.....	188
38365.....	182	39019.....	193	39119.....	193	39321.....	179	39522.....	184	39623.....	197	39735.....	188
38366.....	182	39020.....	198	39120.....	198	39322.....	184	39523.....	179	39624.....	200	39737.....	188
38367.....	182	39021.....	193	39121.....	193	39323.....	179	39524.....	184	39625.....	197	39739.....	188
38368.....	182	39022.....	198	39122.....	198	39324.....	184	39525.....	179	39626.....	200	39741.....	188
38369.....	182	39023.....	193	39123.....	193	39325.....	179	39526.....	184	39627.....	197	39743.....	188
38370.....	182	39024.....	198	39124.....	198	39326.....	184	39527.....	179	39628.....	200	39745.....	188
38371.....	182	39025.....	193	39125.....	193	39327.....	179	39528.....	184	39629.....	197	39747.....	188
38372.....	182	39026.....	198	39126.....	198	39328.....	184	39529.....	179	39630.....	200	39749.....	188
38373.....	182	39027.....	193	39127.....	193	39329.....	179	39530.....	184	39631.....	197	39751.....	188
38374.....	182	39028.....	198	39128.....	198	39330.....	184	39531.....	179	39632.....	200	39753.....	188
38375.....	182	39029.....	193	39129.....	193	39331.....	179	39532.....	184	39633.....	197	39755.....	188
38376.....	182	39030.....	198	39130.....	198	39332.....	184	39533.....	179	39634.....	200	39757.....	188

EDP Number Index

EDP NO.	PAGE	EDP NO.	PAGE	EDP NO.	PAGE	EDP NO.	PAGE	EDP NO.	PAGE	EDP NO.	PAGE	EDP NO.	PAGE
39759.....	188	40310.....	217	41409.....	225	41725.....	213	42693.....	70	43335.....	214	43906.....	218
39761.....	188	40313.....	214	41410.....	227	41729.....	213	42694.....	70	43336.....	217	43907.....	218
39763.....	188	40314.....	217	41413.....	225	41733.....	213	42695.....	70	43345.....	214	43908.....	218
39765.....	188	40317.....	214	41414.....	227	41737.....	213	42696.....	70	43346.....	217	43909.....	218
39767.....	188	40318.....	217	41417.....	225	41741.....	213	42697.....	70	43355.....	214	43910.....	215
39769.....	188	40321.....	214	41418.....	227	41745.....	213	42698.....	70	43356.....	217	43911.....	215
39771.....	188	40322.....	217	41421.....	225	41749.....	213	42699.....	70	43365.....	214	43912.....	215
39773.....	188	40325.....	214	41422.....	227	41753.....	213	42700.....	70	43366.....	217	43913.....	215
39775.....	188	40326.....	217	41425.....	225	41757.....	213	42701.....	70	43375.....	214	43914.....	215
39777.....	188	40329.....	214	41426.....	227	41761.....	213	42702.....	70	43376.....	217	43915.....	215
39789.....	211	40330.....	217	41429.....	225	41765.....	213	42703.....	70	43385.....	214	43916.....	215
40000.....	224	40333.....	214	41430.....	227	42606.....	68	42704.....	70	43386.....	217	43917.....	215
40001.....	224	40334.....	217	41433.....	225	42607.....	68	42705.....	70	43395.....	214	43918.....	215
40003.....	224	40337.....	214	41434.....	227	42608.....	68	42706.....	151	43396.....	217	43919.....	215
40004.....	224	40338.....	217	41437.....	225	42609.....	68	42707.....	151	43445.....	97	43920.....	215
40005.....	224	40341.....	214	41438.....	227	42610.....	68	42708.....	151	43446.....	97	43921.....	215
40007.....	224	40342.....	217	41441.....	225	42611.....	68	42709.....	151	43447.....	97	43922.....	215
40009.....	224	40345.....	214	41442.....	227	42612.....	68	42710.....	151	43448.....	97	43923.....	215
40010.....	224	40346.....	217	41445.....	225	42613.....	68	42711.....	151	43449.....	97	43924.....	215
40011.....	224	40349.....	214	41446.....	227	42614.....	68	42712.....	58	43450.....	97	43925.....	215
40012.....	224	40350.....	217	41449.....	225	42615.....	68	42713.....	58	43451.....	97	43926.....	215
40015.....	224	40353.....	214	41450.....	227	42616.....	68	42714.....	58	43452.....	97	43927.....	215
40016.....	224	40354.....	217	41453.....	225	42617.....	68	42715.....	58	43453.....	97	43928.....	215
40017.....	224	40357.....	214	41454.....	227	42618.....	68	42716.....	58	43470.....	97	43929.....	215
40019.....	224	40358.....	217	41457.....	225	42619.....	68	42717.....	58	43471.....	97	43930.....	215
40020.....	224	40361.....	214	41458.....	227	42620.....	68	42718.....	42	43472.....	97	43931.....	215
40021.....	224	40362.....	217	41461.....	225	42621.....	68	42719.....	42	43473.....	97	43932.....	215
40023.....	224	40365.....	214	41462.....	227	42622.....	68	42721.....	42	43474.....	97	43933.....	215
40024.....	224	40366.....	217	41465.....	225	42623.....	68	42722.....	42	43475.....	97	43934.....	215
40025.....	224	40369.....	214	41466.....	227	42624.....	68	42723.....	42	43476.....	97	43935.....	215
40028.....	224	40370.....	217	41505.....	216	42625.....	68	42731.....	43	43477.....	97	43936.....	215
40030.....	224	40373.....	214	41506.....	219	42626.....	68	42732.....	43	43478.....	97	43937.....	215
40031.....	224	40374.....	217	41509.....	216	42627.....	68	42733.....	43	43479.....	97	43938.....	215
40032.....	224	40377.....	214	41510.....	219	42628.....	70	42734.....	43	43480.....	97	43939.....	215
40035.....	224	40378.....	217	41513.....	216	42630.....	69	42735.....	43	43481.....	97	43950.....	215
40037.....	224	40381.....	214	41514.....	219	42631.....	69	42736.....	43	43482.....	97	43951.....	215
40038.....	224	40382.....	217	41517.....	216	42632.....	70	42737.....	43	43483.....	97	43952.....	215
40039.....	224	40385.....	214	41518.....	219	42633.....	70	42738.....	43	43484.....	97	43953.....	215
40105.....	223	40386.....	217	41521.....	216	42648.....	70	42739.....	43	43485.....	97	43954.....	215
40106.....	226	40505.....	220	41522.....	219	42649.....	70	42750.....	71	43486.....	97	43955.....	215
40109.....	223	40506.....	221	41525.....	216	42650.....	70	42751.....	71	43487.....	97	43956.....	215
40110.....	226	40509.....	220	41526.....	219	42651.....	70	42752.....	71	43488.....	97	43957.....	215
40113.....	223	40510.....	221	41529.....	216	42652.....	70	42753.....	71	43489.....	97	43958.....	215
40114.....	226	40513.....	220	41530.....	219	42653.....	70	42754.....	71	43490.....	97	43959.....	215
40117.....	223	40514.....	221	41533.....	216	42654.....	70	42755.....	71	43491.....	97	44299.....	155
40118.....	226	40517.....	220	41534.....	219	42655.....	70	43101.....	223	43492.....	97	44300.....	155
40121.....	223	40518.....	221	41537.....	216	42656.....	70	43102.....	226	43493.....	97	44301.....	155
40122.....	226	40521.....	220	41538.....	219	42657.....	70	43103.....	223	43494.....	97	44302.....	155
40125.....	223	40522.....	221	41541.....	216	42658.....	70	43104.....	226	43495.....	97	44303.....	155
40126.....	226	40525.....	220	41542.....	219	42659.....	70	43105.....	223	43496.....	97	44304.....	155
40129.....	223	40526.....	221	41545.....	216	42660.....	69	43106.....	226	43497.....	97	44305.....	155
40130.....	226	40529.....	220	41546.....	219	42661.....	69	43107.....	223	43501.....	220	44306.....	155
40133.....	223	40530.....	221	41549.....	216	42662.....	69	43108.....	226	43502.....	221	44307.....	155
40134.....	226	40533.....	220	41550.....	219	42663.....	69	43115.....	223	43503.....	220	44308.....	155
40137.....	223	40534.....	221	41553.....	216	42664.....	69	43116.....	226	43504.....	221	44309.....	155
40138.....	226	40537.....	220	41554.....	219	42665.....	69	43125.....	223	43505.....	220	44505.....	166
40141.....	223	40538.....	221	41557.....	216	42666.....	69	43126.....	226	43506.....	221	44506.....	166
40142.....	226	40541.....	220	41558.....	219	42667.....	69	43135.....	223	43507.....	220	44509.....	166
40145.....	223	40542.....	221	41561.....	216	42668.....	69	43136.....	226	43508.....	221	44510.....	166
40146.....	226	40545.....	220	41562.....	219	42669.....	69	43145.....	223	43515.....	220	44513.....	166
40149.....	223	40546.....	221	41565.....	216	42670.....	69	43146.....	226	43516.....	221	44514.....	166
40150.....	226	40549.....	220	41566.....	219	42671.....	69	43155.....	223	43525.....	220	44517.....	166
40153.....	223	40550.....	221	41605.....	222	42672.....	69	43156.....	226	43526.....	221	44518.....	166
40154.....	226	40553.....	220	41609.....	222	42673.....	69	43165.....	223	43535.....	220	44521.....	166
40157.....	223	40554.....	221	41613.....	222	42674.....	69	43166.....	226	43536.....	221	44522.....	166
40158.....	226	40557.....	220	41617.....	222	42675.....	69	43175.....	223	43545.....	220	44525.....	166
40161.....	223	40558.....	221	41621.....	222	42676.....	69	43176.....	226	43546.....	221	44526.....	166
40162.....	226	40561.....	220	41625.....	222	42677.....	69	43185.....	223	43555.....	220	44529.....	166
40165.....	222	40562.....	221	41629.....	222	42678.....	69	43186.....	226	43556.....	221	44530.....	166
40166.....	226	40565.....	220	41633.....	222	42679.....	69	43195.....	223	43565.....	220	44533.....	166
40169.....	223	40566.....	221	41637.....	222	42680.....	69	43196.....	226	43566.....	221	44534.....	166
40170.....	226	40569.....	220	41641.....	222	42681.....	69	43301.....	214	43575.....	220	44537.....	166
40173.....	223	40570.....	221	41645.....	222	42682.....	69	43302.....	217	43576.....	221	44538.....	166
40174.....	226	40573.....	220	41649.....	222	42683.....	69	43303.....	214	43585.....	220	44541.....	166
40177.....	223	40574.....	221	41653.....	222	42684.....	69	43304.....	217	43586.....	221	44542.....	166
40178.....	226	40577.....	220	41657.....	222	42685.....	69	43305.....	214	43595.....	220	44545.....	166
40181.....	223	40578.....	221	41661.....	222	42686.....	69	43306.....	217	43596.....	221	44546.....	166
40182.....	226	40581.....	220	41665.....	223	42687.....	69	43307.....	214	43900.....	218	44550.....	160
40185.....	223	40582.....	221	41705.....	213	42688.....	69	43308.....	217	43901.....	218	44551.....	160
40186.....	226	40585.....	220	41709.....	213	42689.....	69	43315.....	214	43902.....	218	44552.....	160
40305.....	214	40586.....	221	41713.....	213	42690.....	70	43316.....	217	43903.....	218	44553.....	160
40306.....	217	41405.....	225	41717.....	213	42691.....	70	43325.....	214	43904.....	218	44554.....	160
40309.....	214	41406.....	227	41721.....	213	42692.....	70	43326.....	217	43905.....	218	44555.....	160

EDP Number Index

EDP NO.	PAGE	EDP NO.	PAGE	EDP NO.	PAGE	EDP NO.	PAGE	EDP NO.	PAGE	EDP NO.	PAGE	EDP NO.	PAGE
44556	160	44653	127	44789	152	44875	150	44993	129	45183	81	46147	112
44557	160	44654	127	44790	152	44876	150	44994	129	45184	81	46206	230
44558	160	44685	127	44791	152	44877	150	44995	129	45185	81	46207	230
44559	160	44686	127	44792	152	44878	150	44996	129	45186	81	46208	230
44560	160	44687	127	44793	152	44879	149	44997	129	45187	83	46209	230
44561	161	44688	127	44794	152	44880	150	44998	129	45188	83	46210	230
44562	161	44689	127	44795	152	44881	150	44999	129	45189	83	46211	230
44563	161	44690	127	44796	152	44882	150	45000	129	45190	83	46212	230
44564	161	44691	127	44797	152	44883	150	45001	129	45191	83	46213	230
44565	161	44692	127	44798	152	44884	150	45002	129	45192	83	46214	230
44566	161	44693	127	44799	152	44885	150	45003	129	45193	83	46216	230
44570	162	44694	127	44800	152	44886	150	45004	129	45194	83	46217	230
44571	162	44695	127	44801	152	44889	147	45005	130	45195	83	46218	230
44572	162	44696	127	44802	152	44891	147	45006	130	45196	83	46220	230
44573	162	44701	147	44803	152	44892	147	45007	130	45197	83	46221	230
44574	162	44702	147	44804	152	44893	147	45008	130	45198	83	46222	230
44575	162	44703	147	44805	152	44894	149	45009	130	45199	83	46228	230
44576	162	44705	147	44806	152	44895	147	45010	130	45200	83	46229	230
44577	162	44708	147	44807	152	44896	147	45011	130	45201	83	46230	230
44578	162	44711	147	44808	152	44897	147	45012	130	45202	83	46231	230
44579	162	44714	147	44809	127	44898	147	45013	130	45203	83	46232	230
44580	162	44715	147	44810	127	44899	147	45014	130	45277	234	46233	230
44581	162	44716	147	44811	127	44900	147	45015	130	45279	234	46343	53
44582	162	44717	147	44814	148	44901	147	45016	130	45281	234	46344	53
44583	162	44719	147	44815	148	44902	149	45017	130	45283	234	46345	53
44584	162	44722	147	44816	148	44916	154	45018	130	45285	234	46346	53
44585	162	44725	147	44817	148	44917	154	45019	130	45287	234	46347	53
44586	162	44728	147	44818	148	44918	154	45100	80	45289	234	46348	53
44587	160	44731	147	44819	148	44919	154	45101	80	45291	234	46349	53
44588	160	44732	148	44820	148	44920	154	45102	80	45293	234	46350	53
44589	160	44733	148	44821	148	44921	154	45103	80	45295	234	46351	53
44590	160	44734	148	44822	148	44922	154	45104	80	45297	234	46354	53
44591	160	44735	148	44823	148	44923	154	45105	80	45299	234	46355	53
44592	160	44736	148	44824	148	44924	154	45106	82	45477	235	46356	53
44593	160	44737	148	44826	148	44925	154	45107	82	45478	235	46357	52
44594	160	44738	152	44827	148	44926	154	45108	82	45479	235	46358	52
44595	160	44739	152	44828	148	44927	154	45109	82	45480	235	46359	52
44596	160	44740	152	44829	148	44928	154	45110	82	45481	235	46360	52
44597	160	44741	152	44830	148	44929	154	45111	82	45482	235	46362	52
44598	162	44745	132	44831	148	44930	154	45112	81	45483	235	46364	52
44599	162	44746	132	44832	152	44931	154	45113	81	45484	235	46366	52
44600	162	44747	132	44833	152	44932	154	45114	81	45485	235	46368	52
44601	162	44748	132	44834	152	44933	154	45115	81	45486	235	46370	52
44602	162	44749	132	44835	152	44934	154	45116	81	45487	235	46372	52
44603	162	44750	132	44836	152	44935	154	45117	81	45488	235	46374	52
44604	162	44751	132	44837	152	44936	154	45118	81	45489	235	46376	52
44605	162	44752	132	44838	152	44937	154	45119	81	45490	235	46450	58
44606	162	44753	132	44839	152	44938	154	45120	81	45491	235	46451	58
44607	162	44754	132	44840	152	44939	154	45121	81	45492	235	46452	58
44608	162	44755	132	44841	152	44940	154	45122	81	45493	235	46453	58
44609	161	44756	132	44842	149	44941	154	45123	81	45494	235	46454	58
44610	161	44757	132	44843	149	44942	154	45124	81	45495	235	46455	58
44611	161	44758	132	44844	150	44943	154	45125	81	45496	235	46456	58
44612	161	44759	132	44845	150	44944	154	45126	81	45497	235	46457	58
44613	161	44760	132	44846	149	44945	154	45127	83	45498	235	46458	58
44614	161	44761	132	44847	149	44950	153	45128	83	45499	235	46459	58
44615	162	44762	132	44848	149	44951	153	45129	83	45500	235	46460	58
44616	162	44763	132	44849	149	44952	153	45130	83	46106	232	46461	58
44617	162	44764	132	44850	150	44953	153	45131	83	46107	232	46462	58
44618	162	44765	132	44851	150	44954	153	45132	83	46108	232	46463	58
44619	162	44766	132	44852	150	44955	153	45133	83	46109	232	46464	58
44620	162	44767	132	44853	150	44956	153	45134	83	46110	232	46465	58
44627	132	44768	132	44854	149	44957	153	45135	83	46111	232	46466	58
44628	132	44769	152	44855	149	44958	153	45136	83	46112	232	46467	58
44629	132	44770	152	44856	149	44959	153	45137	83	46113	232	46468	58
44630	132	44771	152	44857	149	44960	153	45138	83	46114	232	46469	58
44631	132	44772	152	44858	150	44961	153	45139	83	46116	232	46470	58
44634	132	44773	152	44859	150	44962	153	45140	83	46117	232	46471	58
44635	132	44774	152	44860	150	44963	153	45141	83	46118	232	46472	58
44636	132	44775	152	44861	150	44964	153	45150	81	46120	232	46473	58
44637	132	44776	152	44862	150	44965	153	45170	81	46121	232	46474	58
44638	132	44777	152	44863	150	44966	153	45171	81	46122	232	46475	58
44639	132	44778	152	44864	150	44967	153	45172	81	46128	232	46476	58
44641	132	44779	152	44865	150	44968	153	45173	81	46129	232	46477	58
44642	132	44780	152	44866	150	44969	153	45174	81	46130	232	46478	58
44643	132	44781	152	44867	150	44970	153	45175	81	46131	232	46479	58
44645	127	44782	152	44868	149	44971	153	45176	81	46132	232	46480	58
44646	127	44783	152	44869	149	44972	153	45177	81	46133	232	46481	58
44647	127	44784	152	44870	149	44973	153	45178	81	46140	112	46482	58
44648	127	44785	152	44871	149	44974	153	45179	81	46141	112	46483	58
44649	127	44786	152	44872	150	44990	129	45180	81	46142	112	46493	42
44650	127	44787	152	44873	150	44891	129	45181	81	46143	112	46494	42
44652	127	44788	152	44874	150	44992	129	45182	81	46145	112	46495	42

EDP Number Index

EDP NO.	PAGE	EDP NO.	PAGE	EDP NO.	PAGE	EDP NO.	PAGE	EDP NO.	PAGE	EDP NO.	PAGE	EDP NO.	PAGE
46497	42	46849	42	47003	33	47086	33	48524	223	48608	226	48692	217
46498	42	46850	42	47004	33	47087	33	48525	223	48609	226	48693	217
46506	52	46851	42	47005	33	47088	33	48526	223	48610	226	48694	217
46507	52	46852	42	47006	33	47089	33	48527	223	48611	226	48695	217
46508	52	46853	42	47007	33	47090	33	48528	223	48612	226	48696	217
46509	52	46854	42	47008	33	47091	33	48529	223	48613	226	48697	217
46510	52	46855	42	47009	33	47092	33	48530	223	48614	226	48698	217
46518	53	46856	42	47010	33	47093	33	48531	223	48615	226	48699	217
46519	53	46857	42	47011	33	47094	33	48532	223	48616	226	48700	217
46520	53	46858	42	47012	33	47095	33	48533	223	48617	226	48701	217
46521	53	46859	42	47013	33	47096	33	48534	223	48618	226	48702	217
46522	53	46860	42	47014	33	47097	33	48535	223	48619	226	48703	217
46560	61	46861	42	47015	33	47120	33	48536	223	48620	226	48704	217
46561	61	46862	42	47016	33	47121	33	48537	223	48621	226	48705	217
46562	61	46863	42	47017	33	47122	33	48538	223	48622	226	48706	217
46563	61	46864	42	47018	33	47123	33	48539	223	48623	226	48707	217
46564	61	46865	42	47019	33	47124	33	48540	223	48624	226	48708	217
46565	61	46866	42	47020	33	47125	33	48541	223	48625	226	48709	217
46566	61	46867	42	47021	33	47126	33	48542	223	48626	226	48710	217
46567	61	46868	42	47022	33	47127	33	48543	223	48627	226	48711	217
46568	61	46869	42	47023	33	47128	33	48544	223	48628	214	48712	217
46620	89	46873	42	47024	33	47129	33	48545	223	48629	214	48714	217
46621	89	46874	42	47025	33	47130	33	48546	223	48630	214	48715	217
46622	89	46880	42	47026	33	47131	33	48547	223	48631	214	48716	217
46623	89	46881	42	47027	33	47132	33	48548	223	48632	214	48717	217
46624	89	46882	42	47028	33	47133	33	48549	223	48633	214	48718	217
46625	89	46884	42	47029	33	47134	33	48550	223	48634	214	48719	217
46626	89	46886	42	47030	33	47135	33	48551	223	48635	214	48720	217
46627	90	46887	42	47031	33	47136	33	48552	223	48636	214	48721	217
46628	90	46889	42	47032	33	47137	33	48553	223	48637	214	48722	217
46629	90	46890	42	47033	33	47138	33	48554	223	48638	214	48723	217
46630	90	46891	42	47034	33	47139	33	48555	223	48639	214	48724	217
46631	90	46893	42	47035	33	47140	33	48556	223	48640	214	48725	217
46632	90	46894	42	47036	33	47141	33	48557	223	48641	214	48726	217
46633	90	46895	42	47037	33	47142	33	48558	223	48642	214	48727	217
46634	90	46896	42	47038	33	47143	33	48559	223	48643	214	48728	217
46635	90	46898	42	47039	33	47144	33	48560	223	48644	214	48729	217
46636	90	46899	42	47040	33	47145	33	48561	223	48645	214	48730	217
46637	90	46900	42	47041	33	47146	33	48562	223	48646	214	48731	217
46638	90	46903	42	47042	33	47147	33	48563	223	48647	214	48732	217
46639	90	46904	42	47043	33	47148	33	48564	226	48648	214	48733	217
46640	90	46905	42	47044	33	47160	33	48565	226	48650	214	48734	217
46641	90	46909	42	47045	33	47161	33	48566	226	48651	214	48735	217
46642	90	46910	42	47046	33	47162	33	48567	226	48652	214	48736	217
46643	90	46911	42	47047	33	47163	33	48568	226	48653	214	48737	217
46644	90	46912	42	47048	33	47164	33	48569	226	48654	214	48738	217
46645	90	46913	42	47049	33	47165	33	48570	226	48655	214	48739	217
46646	90	46914	42	47050	33	47166	33	48571	226	48656	214	48740	217
46647	91	46915	42	47051	33	47167	33	48572	226	48657	214	48741	217
46648	91	46916	42	47052	33	47168	33	48573	226	48658	214	48742	217
46649	91	46917	42	47053	33	47169	33	48574	226	48659	214	48743	217
46650	91	46918	42	47054	33	47170	33	48575	226	48660	214	48744	217
46651	91	46919	42	47055	33	47171	33	48576	226	48661	214	48745	217
46652	91	46920	42	47056	33	47172	33	48577	226	48662	214	48746	217
46653	91	46921	42	47057	33	47173	33	48578	226	48663	214	48747	217
46654	91	46922	42	47058	33	48002	33	48579	226	48664	214	48748	217
46655	91	46923	42	47059	33	48003	33	48580	226	48665	214	48749	217
46656	91	46924	42	47060	33	48012	33	48581	226	48666	214	48750	217
46657	91	46925	42	47061	33	48020	33	48582	226	48667	214	48751	217
46658	91	46926	42	47062	33	48070	33	48583	226	48668	214	48752	217
46659	91	46927	42	47063	33	48500	223	48584	226	48669	214	48753	217
46660	91	46928	44	47064	33	48501	223	48586	226	48670	214	48754	217
46821	44	46929	44	47065	33	48502	223	48587	226	48671	214	48755	217
46822	44	46930	44	47066	33	48503	223	48588	226	48672	214	48756	220
46823	44	46931	44	47067	33	48504	223	48589	226	48673	214	48757	220
46824	44	46932	44	47068	33	48505	223	48590	226	48674	214	48758	220
46825	44	46933	44	47069	33	48506	223	48591	226	48675	214	48759	220
46826	44	46934	44	47070	33	48507	223	48592	226	48676	214	48760	220
46827	44	46935	44	47071	33	48508	223	48593	226	48677	214	48761	220
46828	44	46936	44	47072	33	48509	223	48594	226	48678	214	48762	220
46829	44	46937	44	47073	33	48510	223	48595	226	48679	214	48763	220
46830	44	46938	44	47074	33	48511	223	48596	226	48680	214	48764	220
46831	44	46939	44	47075	33	48512	223	48597	226	48681	214	48765	220
46832	44	46940	44	47076	33	48513	223	48598	226	48682	214	48766	220
46833	44	46941	44	47077	33	48514	223	48599	226	48683	214	48767	220
46834	44	46942	44	47078	33	48515	223	48600	226	48684	214	48768	220
46835	44	46943	44	47079	33	48516	223	48601	226	48685	214	48769	220
46836	44	46944	42	47080	33	48517	223	48602	226	48686	214	48770	220
46837	44	46945	42	47081	33	48518	223	48603	226	48687	214	48771	220
46838	44	46946	42	47082	33	48519	223	48604	226	48688	214	48772	220
46839	44	47000	33	47083	33	48520	223	48605	226	48689	214	48773	220
46840	44	47001	33	47084	33	48522	223	48606	226	48690	214	48774	220
46841	44	47002	33	47085	33	48523	223	48607	226	48691	214	48775	220

EDP Number Index

EDP NO.	PAGE	EDP NO.	PAGE	EDP NO.	PAGE	EDP NO.	PAGE	EDP NO.	PAGE	EDP NO.	PAGE	EDP NO.	PAGE
69054.....	321	70489.....	100	73028.....	356	74228.....	333	82980.....	364	84280.....	354	91241.....	168
69055.....	321	70527.....	104	73029.....	356	74231.....	333	82981.....	364	84281.....	354	91242.....	168
69056.....	321	70529.....	104	73041.....	356	74234.....	333	82982.....	364	84282.....	354	91243.....	168
70003.....	340	70531.....	104	73070.....	357	74237.....	333	82983.....	364	84283.....	354	91244.....	168
70004.....	340	70533.....	104	73071.....	357	74240.....	333	82984.....	364	84284.....	354	91245.....	168
70005.....	340	70535.....	104	73072.....	357	74243.....	333	82985.....	364	84285.....	354	91246.....	168
70006.....	340	70537.....	104	73073.....	357	74246.....	333	82986.....	364	84286.....	354	91247.....	168
70007.....	340	70539.....	104	73074.....	357	74249.....	336	82987.....	364	84287.....	354	91248.....	168
70008.....	340	70540.....	104	73075.....	357	74252.....	336	82988.....	364	84288.....	354	91250.....	168
70009.....	340	70542.....	104	73078.....	357	74255.....	336	82989.....	364	84289.....	354	91251.....	168
70010.....	340	70544.....	104	73079.....	357	74258.....	336	82990.....	368	84290.....	354	91252.....	168
70011.....	340	70546.....	104	73080.....	357	74261.....	336	82991.....	368	84291.....	354	91253.....	168
70012.....	340	70548.....	104	73081.....	357	74264.....	336	82992.....	368	85080.....	354	91254.....	168
70013.....	340	70550.....	104	73082.....	357	74267.....	336	82993.....	368	85081.....	354	91255.....	168
70014.....	340	70551.....	103	73083.....	357	74270.....	336	82994.....	368	85082.....	354	91256.....	168
70015.....	340	70552.....	103	74001.....	330	74280.....	352	82995.....	368	85083.....	354	91257.....	168
70016.....	340	70553.....	103	74004.....	330	74281.....	352	82996.....	368	85084.....	354	91258.....	168
70017.....	340	70554.....	103	74007.....	330	74282.....	352	82997.....	368	85085.....	354	91259.....	168
70018.....	340	70555.....	103	74010.....	330	74283.....	352	82998.....	368	85086.....	354	91260.....	168
70019.....	340	70556.....	103	74013.....	330	74284.....	352	83027.....	359	85087.....	354	91261.....	168
70020.....	340	70557.....	103	74016.....	330	74285.....	352	83028.....	359	85088.....	354	91262.....	168
70021.....	340	70558.....	103	74019.....	330	74286.....	352	83029.....	359	85089.....	354	91263.....	168
70022.....	340	70559.....	103	74022.....	330	74287.....	352	83041.....	359	85090.....	354	91266.....	179
70023.....	340	70560.....	103	74025.....	333	74288.....	352	83042.....	359	85091.....	354	91268.....	193
70024.....	340	70561.....	103	74028.....	333	74289.....	352	83043.....	359	90001.....	370	91269.....	198
70025.....	340	70562.....	103	74031.....	333	74290.....	352	83044.....	359	90005.....	370	91270.....	179
70026.....	340	70563.....	103	74034.....	333	74291.....	352	83056.....	116	90009.....	370	91272.....	193
70027.....	340	72930.....	356	74037.....	333	75080.....	352	83057.....	116	90013.....	370	91273.....	198
70028.....	340	72947.....	356	74040.....	333	75081.....	352	83058.....	116	90017.....	370	91274.....	179
70029.....	340	72948.....	356	74043.....	333	75082.....	352	83059.....	116	90021.....	370	91276.....	193
70030.....	340	72949.....	356	74046.....	333	75083.....	352	83060.....	116	90025.....	370	91277.....	198
70031.....	340	72950.....	356	74049.....	336	75084.....	352	83061.....	116	90029.....	370	91278.....	179
70032.....	340	72951.....	356	74052.....	336	75085.....	352	83062.....	116	90033.....	370	91280.....	193
70441.....	101	72952.....	356	74055.....	336	75086.....	352	83063.....	116	90037.....	370	91281.....	198
70442.....	101	72953.....	356	74058.....	336	75087.....	352	83064.....	116	90041.....	370	91282.....	179
70444.....	101	72954.....	362	74061.....	336	75088.....	352	83065.....	116	90045.....	370	91284.....	193
70445.....	101	72955.....	362	74064.....	336	75089.....	352	83070.....	359	90049.....	370	91285.....	198
70447.....	101	72956.....	362	74067.....	336	75090.....	352	83071.....	359	90053.....	370	91286.....	179
70448.....	101	72957.....	362	74070.....	336	75091.....	352	83072.....	359	90101.....	373	91288.....	194
70450.....	101	72958.....	362	74101.....	330	81001.....	344	83073.....	359	90107.....	373	91289.....	199
70451.....	101	72959.....	362	74104.....	330	81003.....	344	83100.....	359	90109.....	373	91290.....	180
70453.....	101	72960.....	362	74107.....	330	81005.....	344	83101.....	359	90113.....	373	91292.....	194
70454.....	101	72961.....	362	74110.....	330	81007.....	344	83102.....	359	90121.....	373	91293.....	199
70456.....	101	72962.....	362	74113.....	330	81009.....	344	83103.....	359	90129.....	373	91349.....	108
70457.....	101	72963.....	362	74116.....	330	81011.....	344	83104.....	359	90137.....	373	91350.....	108
70459.....	101	72964.....	362	74119.....	330	81013.....	344	83105.....	359	91001.....	371	91351.....	108
70460.....	101	72965.....	362	74122.....	330	81015.....	344	83106.....	359	91005.....	371	91352.....	108
70462.....	101	72966.....	362	74125.....	333	81017.....	344	83107.....	359	91009.....	371	91353.....	108
70463.....	101	72967.....	362	74128.....	333	81019.....	344	83108.....	359	91013.....	371	91354.....	108
70465.....	101	72968.....	362	74131.....	333	81021.....	344	83109.....	359	91017.....	371	91355.....	108
70466.....	101	72969.....	362	74134.....	333	81023.....	344	83110.....	359	91021.....	371	91356.....	108
70468.....	101	72970.....	366	74137.....	333	81025.....	344	83111.....	359	91025.....	371	91357.....	108
70469.....	101	72971.....	366	74140.....	333	81027.....	344	83200.....	364	91029.....	371	91358.....	108
70470.....	100	72972.....	366	74143.....	333	81029.....	344	83201.....	364	91033.....	371	91359.....	108
70471.....	100	72973.....	366	74146.....	333	82930.....	359	83202.....	364	91037.....	371	91360.....	108
70472.....	100	72974.....	366	74149.....	336	82931.....	359	83203.....	364	91041.....	371	91361.....	108
70473.....	100	72975.....	366	74152.....	336	82932.....	359	83204.....	364	91045.....	371	93272.....	106
70474.....	100	72976.....	366	74155.....	336	82933.....	359	83205.....	364	91049.....	371	93273.....	106
70475.....	100	72977.....	366	74158.....	336	82966.....	359	83206.....	364	91053.....	371	93274.....	106
70476.....	100	72978.....	114	74161.....	336	82967.....	359	83207.....	364	91101.....	374	93275.....	106
70477.....	100	72979.....	114	74164.....	336	82968.....	359	83220.....	360	91107.....	374	93276.....	106
70478.....	100	72980.....	114	74167.....	336	82969.....	359	83221.....	360	91109.....	374	93277.....	106
70479.....	100	72981.....	114	74170.....	336	82970.....	359	83222.....	360	91113.....	374	93278.....	106
70480.....	100	72982.....	114	74201.....	330	82971.....	359	83223.....	360	91121.....	374	93279.....	106
70481.....	100	72983.....	114	74204.....	330	82972.....	359	83224.....	360	91129.....	374	93280.....	106
70482.....	100	72984.....	114	74207.....	330	82973.....	359	83225.....	360	91137.....	374	93281.....	106
70483.....	100	72985.....	114	74210.....	330	82974.....	364	83230.....	360	91235.....	168	93282.....	106
70484.....	100	73012.....	356	74213.....	330	82975.....	364	83231.....	360	91236.....	168		
70485.....	100	73013.....	356	74216.....	330	82976.....	364	83232.....	360	91237.....	168		
70486.....	100	73014.....	356	74219.....	330	82977.....	364	83233.....	360	91238.....	168		
70487.....	100	73026.....	356	74222.....	330	82978.....	364	83234.....	360	91239.....	168		
70488.....	100	73027.....	356	74225.....	333	82979.....	364	83235.....	360	91240.....	168		

KSPT Reference Information

ISO H6 SPECIFICATIONS					
DIAMETER	+	-	DIAMETER	+	-
≥ 1/8 - 3/16	0.00000	-0.00032	≤ 3	0,000	0,006
> 3/16 - 7/16	0.00000	-0.00035	> 3 - 6	0,000	0,008
> 7/16 - 5/8	0.00000	-0.00043	> 6 - 10	0,000	0,009
> 5/8 - 1	0.00000	-0.00051	> 10 - 18	0,000	0,011
> 1 - 1-1/4	0.00000	-0.00063	> 18 - 25	0,000	0,013

MACHINING FORMULAS	
INCH FORMULAS	METRIC FORMULAS
sfm = rpm x .262 x cutting diameter	m/min = (3.14 x cutting diameter x rpm) / 1000
rpm = sfm x 3.82 / cutting diameter	rpm = (1000 x m / min) / (3.14 x cutting diameter)
feed (inches per tooth) = ipm / (number of teeth x rpm)	feed (mm per tooth) = millimeters per minute / (number of teeth x rpm)
feed (inches / minute) = inches per tooth x number of teeth x rpm	feed (mm/minute) = feed per tooth x number of teeth x rpm
feed (inches / minute) = ipr x rpm	feed (mm/minute) = mmr x rpm
feed (inches / revolution) = ipm / rpm	feed (mm per revolution) = mmr / rpm
cuspl height* = (tool diameter / 2) - $\sqrt{(\text{tool diameter}^2 - \text{pitch}^2) / 4}$	cuspl height* = (tool diameter / 2) - $\sqrt{(\text{tool diameter}^2 - \text{pitch}^2) / 4}$
pitch = $\sqrt{4 \times (\text{cuspl height} \times \text{tool diameter}) - 4 \times (\text{cuspl height}^2)}$	pitch = $\sqrt{4 \times (\text{cuspl height} \times \text{tool diameter}) - 4 \times (\text{cuspl height}^2)}$
mrr – milling – (in ³ /min) = width of cut x depth of cut x ipm	mrr – milling – (cm ³ /min) = (width of cut x depth of cut x mm/min) / 1000
cutting time – drilling – (minutes) = length / ipm	cutting time – drilling – (minutes) = length / mm/min

sfm	surface feet per minute
rpm	revolutions per minute
ipm	feed rate in inches per minutes
ipr	inches per revolution
mmr	millimeters per revolution
mm/min	feed rate in millimeters per minute
mrr	material removal rate
*	on flat surface

GENERAL FORMULAS	
coolant pressure: 1 Bar = 14.5 Pounds per Square Inch (PSI)	
calculation of coolant pressure: Pounds Per Square Inch (PSI) = (Horsepower of Pump x 1.460) / Gallons per Minute (GPM)	
1 Liter = 0.254 Gallons	
inch = millimeters / 25.4	millimeters = inch x 25.4
inch tap drill sizes = major diameter - ((1.299 x % of thread) / threads per inch)	
metric tap drill sizes = major diameter - (1.082 x pitch x % of thread)	
inch thread forming drill size: maximum diameter = basic major diameter - (3/8 x number of threads per inch)	
inch thread forming drill size: minimum diameter = basic major diameter - (1/2 x number of threads per inch)	
metric thread forming drill size: maximum diameter = basic major diameter - (.375 x pitch)	
metric thread forming drill size: minimum diameter = basic major diameter - (.500 x pitch)	

Decimal Equivalents

Fraction • Number • Letter • Metric Sizes

INCH	METRIC	DECIMAL EQUIVALENT	INCH	METRIC	DECIMAL EQUIVALENT	INCH	METRIC	DECIMAL EQUIVALENT	INCH	METRIC	DECIMAL EQUIVALENT	INCH	METRIC	DECIMAL EQUIVALENT	INCH	METRIC	DECIMAL EQUIVALENT
–	0,10	0.0039	–	1,60	0.0630	9/64	3,57	0.1406	#1	5,79	0.2280	R	8,61	0.3390	–	13,00	0.5118
–	0,20	0.0079	#52	1,61	0.0635	–	3,60	0.1417	–	5,80	0.2283	–	8,70	0.3425	33/64	13,10	0.5156
–	0,25	0.0098	–	1,65	0.0650	#27	3,66	0.1440	–	5,90	0.2323	11/32	8,73	0.3438	17/32	13,49	0.5312
–	0,30	0.0118	#51	1,70	0.0669	–	3,70	0.1457	A	5,94	0.2340	–	8,75	0.3445	–	13,50	0.5315
#80	0,34	0.0135	–	1,75	0.0689	#26	3,73	0.1470	15/64	5,95	0.2344	–	8,80	0.3465	35/64	13,89	0.5469
–	0,35	0.0138	#50	1,78	0.0700	–	3,75	0.1476	–	6,00	0.2362	S	8,84	0.3480	–	14,00	0.5512
#79	0,37	0.0145	–	1,80	0.0709	#25	3,80	0.1495	B	6,05	0.2380	–	8,90	0.3504	9/16	14,29	0.5625
1/64	0,40	0.0156	#49	1,85	0.0728	–	3,80	0.1496	–	6,10	0.2402	–	9,00	0.3543	–	14,50	0.5709
#78	0,41	0.0160	–	1,90	0.0748	#24	3,86	0.1520	C	6,15	0.2420	T	9,09	0.3580	37/64	14,68	0.5781
–	0,45	0.0177	#48	1,93	0.0760	–	3,90	0.1535	–	6,20	0.2441	–	9,10	0.3583	–	15,00	0.5906
#77	0,46	0.0180	–	1,95	0.0768	#23	3,91	0.1540	D	6,25	0.2461	23/64	9,13	0.3594	19/32	15,08	0.5938
–	0,50	0.0197	5/64	1,98	0.0781	5/32	3,97	0.1562	–	6,30	0.2480	–	9,20	0.3622	39/64	15,48	0.6094
#76	0,51	0.0200	#47	1,99	0.0785	#22	3,99	0.1570	E	6,35	0.2500	–	9,25	0.3642	–	15,50	0.6102
#75	0,53	0.0210	–	2,00	0.0787	–	4,00	0.1575	1/4	6,35	0.2500	–	9,30	0.3661	5/8	15,88	0.6250
–	0,55	0.0217	–	2,05	0.0807	#21	4,04	0.1590	–	6,40	0.2520	U	9,35	0.3680	–	16,00	0.6299
#74	0,57	0.0225	#46	2,06	0.0810	#20	4,09	0.1610	–	6,50	0.2559	–	9,40	0.3701	41/64	16,27	0.6406
–	0,60	0.0236	#45	2,08	0.0820	–	4,10	0.1614	F	6,53	0.2570	–	9,50	0.3740	–	16,50	0.6496
#73	0,61	0.0240	–	2,10	0.0827	–	4,20	0.1654	–	6,60	0.2598	3/8	9,53	0.3750	21/32	16,67	0.6562
#72	0,64	0.0250	–	2,15	0.0846	#19	4,22	0.1660	G	6,63	0.2610	V	9,56	0.3770	–	17,00	0.6693
–	0,65	0.0256	#44	2,18	0.0860	–	4,25	0.1673	–	6,70	0.2638	–	9,60	0.3780	43/64	17,07	0.6719
#71	0,66	0.0260	–	2,20	0.0866	–	4,30	0.1693	17/64	6,75	0.2656	–	9,70	0.3819	11/16	17,46	0.6875
–	0,70	0.0276	–	2,25	0.0886	#18	4,31	0.1695	H	6,76	0.2660	–	9,75	0.3839	–	17,50	0.6890
#70	0,71	0.0280	#43	2,26	0.0890	11/64	4,37	0.1719	–	6,80	0.2677	W	9,80	0.3858	45/64	17,86	0.7031
#69	0,74	0.0292	–	2,30	0.0906	#17	4,39	0.1730	–	6,90	0.2717	–	9,90	0.3898	–	18,00	0.7087
–	0,75	0.0295	–	2,35	0.0925	–	4,40	0.1732	I	6,91	0.2720	25/64	9,92	0.3906	23/32	18,26	0.7188
#68	0,79	0.0310	#42	2,37	0.0935	#16	4,50	0.1770	–	7,00	0.2756	–	10,00	0.3937	–	18,50	0.7283
1/32	0,79	0.0313	3/32	2,38	0.0938	–	4,50	0.1772	J	7,04	0.2770	X	10,08	0.3970	47/64	18,65	0.7344
–	0,80	0.0315	–	2,40	0.0945	#15	4,57	0.1800	–	7,10	0.2795	–	10,10	0.3976	–	19,00	0.7480
#67	0,81	0.0320	#41	2,44	0.0960	–	4,60	0.1811	K	7,14	0.2810	–	10,20	0.4016	3/4	19,05	0.7500
#66	0,84	0.0330	–	2,45	0.0965	#14	4,62	0.1820	9/32	7,14	0.2812	Y	10,26	0.4040	49/64	19,45	0.7656
–	0,85	0.0335	#40	2,50	0.0984	#13	4,70	0.1850	–	7,20	0.2835	–	10,30	0.4055	–	19,50	0.7677
#65	0,89	0.0350	#39	2,53	0.0995	–	4,75	0.1870	–	7,25	0.2854	13/32	10,32	0.4062	25/32	19,84	0.7812
–	0,90	0.0354	#38	2,58	0.1015	3/16	4,76	0.1875	–	7,30	0.2874	–	10,40	0.4094	–	20,00	0.7874
#64	0,91	0.0360	–	2,60	0.1024	#12	4,80	0.1890	L	7,37	0.2900	Z	10,49	0.4130	51/64	20,24	0.7969
#63	0,94	0.0370	#37	2,64	0.1040	#11	4,85	0.1910	–	7,40	0.2913	–	10,50	0.4134	–	20,50	0.8071
–	0,95	0.0374	–	2,70	0.1063	–	4,90	0.1929	M	7,49	0.2950	–	10,60	0.4173	13/16	20,64	0.8125
#62	0,97	0.0380	#36	2,71	0.1065	#10	4,91	0.1935	–	7,50	0.2953	–	10,70	0.4213	–	21,00	0.8268
#61	0,99	0.0390	–	2,75	0.1083	#9	4,98	0.1960	19/64	7,54	0.2969	27/64	10,72	0.4219	53/64	21,03	0.8281
–	1,00	0.0394	7/64	2,78	0.1094	–	5,00	0.1969	–	7,60	0.2992	–	10,80	0.4252	27/32	21,43	0.8438
#60	1,02	0.0400	#35	2,79	0.1100	#8	5,05	0.1990	N	7,67	0.3020	–	10,90	0.4291	–	21,50	0.8465
#59	1,04	0.0410	–	2,80	0.1102	–	5,10	0.2008	–	7,70	0.3031	–	11,00	0.4331	55/64	21,84	0.8594
–	1,05	0.0413	#34	2,82	0.1110	#7	5,11	0.2010	–	7,75	0.3051	–	11,10	0.4370	–	22,00	0.8661
#58	1,07	0.0420	#33	2,87	0.1130	13/64	5,16	0.2031	–	7,80	0.3071	7/16	11,11	0.4375	7/8	22,23	0.8750
#57	1,09	0.0430	–	2,90	0.1142	#6	5,18	0.2040	–	7,90	0.3110	–	11,20	0.4409	–	22,50	0.8858
–	1,10	0.0433	#32	2,95	0.1160	–	5,20	0.2047	5/16	7,94	0.3125	–	11,30	0.4449	57/64	22,62	0.8906
–	1,15	0.0453	–	3,00	0.1181	#5	5,22	0.2055	–	8,00	0.3150	–	11,40	0.4488	–	23,00	0.9055
#56	1,18	0.0465	#31	3,05	0.1200	–	5,25	0.2067	O	8,03	0.3160	–	11,50	0.4528	29/32	23,02	0.9062
3/64	1,19	0.0469	–	3,10	0.1220	–	5,3	0.2087	–	8,10	0.3189	29/64	11,51	0.4531	59/64	23,42	0.9219
–	1,20	0.0472	1/8	3,18	0.1250	#4	5,31	0.2090	–	8,20	0.3228	–	11,60	0.4567	–	23,50	0.9252
–	1,25	0.0492	–	3,20	0.1260	–	5,40	0.2126	P	8,20	0.3230	–	11,70	0.4606	15/16	23,81	0.9375
–	1,30	0.0512	–	3,25	0.1280	#3	5,41	0.2130	–	8,25	0.3248	–	11,80	0.4646	–	24,00	0.9449
#55	1,32	0.0520	#30	3,26	0.1285	–	5,50	0.2165	–	8,30	0.3268	–	11,90	0.4685	61/64	24,21	0.9531
–	1,35	0.0531	–	3,30	0.1299	7/32	5,56	0.2188	21/64	8,33	0.3281	15/32	11,91	0.4688	–	24,50	0.9646
#54	1,40	0.0550	–	3,40	0.1339	–	5,60	0.2205	–	8,40	0.3307	–	12,00	0.4724	31/32	24,61	0.9688
#53	1,51	0.0595	#29	3,45	0.1360	#2	5,61	0.2210	Q	8,43	0.3320	31/64	12,30	0.4844	–	25,00	0.9843
–	1,55	0.0610	–	3,50	0.1378	–	5,70	0.2244	–	8,50	0.3346	–	12,50	0.4921	63/64	25,00	0.9844
1/16	1,59	0.0625	#28	3,57	0.1405	–	5,75	0.2264	–	8,60	0.3386	1/2	12,70	0.5000	1	25,40	1.0000

Hardness Conversion Chart

ROCKWELL HARDNESS (HRb)	ROCKWELL HARDNESS (HRc)	BRINELL HARDNESS (HB)	VICKERS HARDNESS (HV)	TENSILE STRENGTH (N/mm ²)	PSI (1000lb/in ²)
67	—	121	122	401	58
70	—	126	127	432	63
73	—	132	132	448	65
75	—	136	137	455	66
77	—	140	143	463	67
80	—	147	150	479	69
82	—	153	156	494	72
84	—	159	163	525	76
86	—	165	171	540	78
89	—	177	178	556	81
91	—	186	188	602	88
93	—	197	196	632	92
96	—	216	212	664	97
97	—	223	218	695	101
98	21	230	234	756	110
—	22	236	241	772	112
—	23	242	247	787	114
—	24	248	255	818	118
—	25	254	261	849	123
—	27	266	269	865	125
—	28	272	275	895	130
—	29	278	284	911	132
—	30	284	292	942	136
—	31	293	300	973	141
—	32	302	308	988	143
—	33	310	318	1019	147
—	34	319	327	1050	152
—	35	328	337	1096	159
—	37	345	349	1127	163
—	38	353	359	1158	168
—	39	362	370	1189	172
—	40	370	381	1235	179
—	41	381	395	1266	183
—	42	391	408	1312	190
—	44	411	422	1359	197
—	45	422	437	1420	206
—	46	433	452	1467	212
—	48	455	470	1513	219
—	50	479	497	1559	226
—	51	485	517	1621	235
—	52	497	532	1668	241
—	54	—	573	1729	250
—	56	—	609	1807	262
—	57	—	630	1884	273
—	59	—	670	1961	284
—	60	—	698	2039	295
—	61	—	725	—	—
—	62	—	740	—	—
—	63	—	780	—	—
—	64	—	812	—	—
—	65	—	847	—	—
—	66	—	885	—	—
—	67	—	926	—	—
—	68	—	971	—	—

Conversions from each scale are approximate

SOLUTIONS AROUND THE GLOBE

KYOCERA SGS Precision Tools is an ISO-certified leader of round solid carbide cutting tool technology for the aerospace, metalworking, and automotive industries with manufacturing sites in the United States and United Kingdom. Our global network of Sales Representatives, Industrial Distributors, and Agents blanket the world selling into more than 60 countries.

LEADERS IN SOLID CARBIDE TOOL TECHNOLOGY

Brand names such as Z-Carb, S-Carb®, V-Carb, Hi-PerCarb, Multi-Carb have become synonymous with high performance tooling in the machining and metalworking industry.

We're proud to have pioneered some of the world's most advanced cutting technology right here on our Northeast Ohio manufacturing campus. KSPT high performance end mills, drills and routers are increasing productivity and reducing cost around the world.

EXCEEDING CUSTOMER EXPECTATIONS

As the world's manufacturing needs change, so does KSPT. It's all about the science, starting with our lab inspected substrate materials to our tool designs and coatings. Our exceptional team of researchers, engineers, and machinists are dedicated to developing the absolute best and delivering the ultimate Value at the spindle®.

- Incredible batch-to-batch consistency
- Metallurgical lab dedicated to testing and rigorous quality control
- ISO-certified quality procedures
- Patented geometries that extend tool life, reduce chatter, cut cycle times, and improve part quality—even at extreme parameters
- Specialists in extreme and demanding product applications
- Comprehensive tooling services
- Experienced Field Sales Engineers who work to optimize a tool for your particular application
- Dedicated multi-lingual customer service representatives

KSPT PRODUCTS ARE DISTRIBUTED BY:



www.kyocera-sgstool.com



UNITED STATES OF AMERICA

KYOCERA SGS Precision Tools
P.O. Box 187
55 South Main Street
Munroe Falls, Ohio 44262 U.S.A.
customer service -
US and Canada: (330) 686-5700
fax - US & Canada: (800) 447-4017
international fax: (330) 686-2146
orders: sales@kyocera-sgstool.com
web: www.kyocera-sgstool.com

UNITED KINGDOM

KYOCERA SGS Precision Tools Europe Ltd.
10 Ashville Way
Wokingham, Berkshire
RG41 2PL England
phone: (44) 1189-795-200
fax: (44) 1189-795-295
e-mail: SalesEU@kyocera-sgstool.com
web: www.kyocera-sgstool.eu

JAPAN

KYOCERA Corporation
International Sales Dept.
6 Takeda Tobadono-cho,
Fushimi-ku, Kyoto 612-8501, Japan
phone: +81-75-604-3473
fax: +81-75-604-3472
web: global.kyocera.com/prdct/tool/index.html

COMMERICAL OFFICES

EASTERN EUROPE

SINTCOM
Sintcom Tools
95 Arsenalski Blvd.
1421 Sofia, Bulgaria
phone: (359) 283-64421
fax: (359) 286-52493
e-mail: sintcom@sintcomtools.com

FRANCE

DOGA-KSPTE FRANCE
8, Avenue Gutenberg
78310 Maurepas, France
phone: +33 (0) 1 30 66 41 64
fax: +33 (0) 1 30 66 41 49
e-mail: KSPTF@kyocera-sgstool.com
web: www.doga.fr

INDIA

KYOCERA Asia Pacific India Pvt. Ltd
Plot No.51, Phase-I,
Udyog Vihar Gurgaon 122016,
Haryana, India
phone: +91-124-4025022
fax: +91-124-4025001

KOREA

KYOCERA Precision Tools Korea Co., Ltd.
2LT 69BL, Namdong Industrial Estate,
638-1, Kozan-Dong, Namdong Incheon,
Korea
phone: +82-32-821-8365
fax: +82-32-821-8369
web: www.kptk.co.kr/

POLAND

KYOCERA SGS Precision Tools
phone: +48 530 432 002
e-mail: SalesEU@kyocera-sgstool.com

RUSSIA

HALTEC
phone: (7) 495-252-05-00
e-mail: info@haltec.ru
web: www.haltec.ru

SPAIN

KYOCERA SGS Precision Tools IBERICA
e-mail: SalesEU@kyocera-sgstool.com

THAILAND

KYOCERA Asia Pacific (Thailand) Co., Ltd.
1 Capital Work Place Building
7th Floor, Soi Chamchan, Sukhumvit
55 Road, Klongton Nua, Wattana,
Bangkok 10110, Thailand
phone: +66-2-030-6688
fax: +66-2-030-6600

SINGAPORE

KYOCERA Asia Pacific Pte. Ltd.
298 Tiong Bahru Road, #13-03/05 Central Plaza,
Singapore 168730
phone: +65-6373-6700
fax: +65-6271-0600
web: asia.kyocera.com/products/cuttingtools/
index.html

CHINA

KYOCERA (China) Sales & Trading Corporation
Room 140, Building A3, Daning Central Square,
No. 700 Wanrong Road,
Zhabei District, Shanghai, 200072,
P.R. China
phone: +86-21-3660-7711
fax: +86-21-568-6200
web: www.kyocera.com.cn/prdct/cuttingtool