

MILLSTAR®

A *Cole* TOOLING SYSTEMS CO.

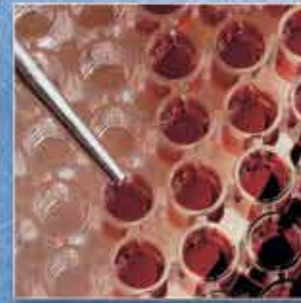

2017 | 2018 PRODUCT CATALOG

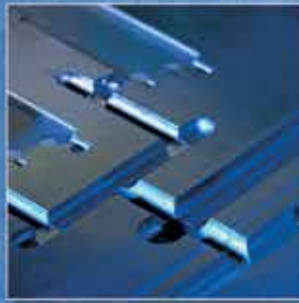

Catalog Contents:

Profile and Copy Milling Program *Inch 6 • Metric 58*

Graphite Machining Program *Inch 8 • Metric 60*

PCD & CBN Inserts *Inch 18 • Metric 72*

Copy Milling / Button Insert Cutters *Inch 24 • Metric 77*

APKT Square Shoulder Cutters *Inch 28 • Metric 82*

Aluminum Milling Cutters *Inch 30 • Metric 83*

High Feed Indexable Milling Program *Inch 32 • Metric 87*

Solid Carbide End Mill Program *Inch 39 • Metric 97*

SD Collet & HM Milling Chucks *Inch 50 • Metric 117*

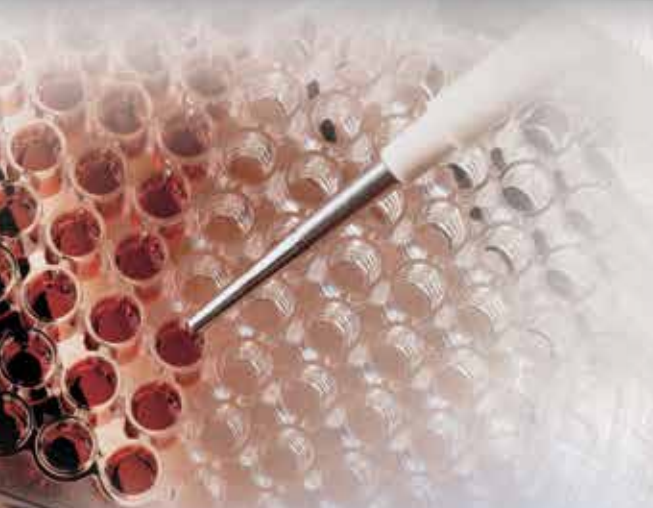

Millstar is an industry leader in producing die and mold profile tooling and solid carbide tools. Millstar tools are designed for conventional profile machining, and high speed and hard milling with modern machine tools and methods.

Millstar Profile Milling Tools represent the latest in profile and contour milling technology, resulting in shorter machining and lead times, higher machining accuracy and true contouring results.

Customers include die and mold machining companies, aluminum extrusion companies, high speed machining mold makers, and aerospace and medical component industries. Insert tooling is typically used in roughing and finishing applications.

The Millstar product line is manufactured in the USA, and all tools are fully traceable. Nearly six decades of cutting tool design and manufacturing for automotive, aerospace and many other industries, as well as special design capabilities using 3-D CAD allow us to respond quickly to requests for special designs.



Insert Overview

The Inserts

Millstar inserts are fully ground precision inserts for better chip control, faster metal removal and higher surface accuracies. They are far more accurate than pressed and O.D. sharpened inserts.

- Positive ground chipbreaker or strong negative cutting edge designs guarantee outstanding cutting performance in a wide variety of ferrous and non-ferrous materials.
- A choice of state-of-the-art insert grades, designs and tool coatings allow for optimum speed and feed rates in wet and dry machining. Reduced machining times by 25% to 60% are not uncommon.
- Economical one-piece inserts with two cutting edges are cost-effective for contour milling. True radius geometry is fully CNC-ground for higher machining accuracy and greatly reduced manual finishing and polishing time.

- Choose from side-cutting ball nose inserts with 180 degree nose radius, and popular ball nose inserts with a cutting edge covering 230 degrees for steep wall up-and-down ramping, profiling, contour milling and blending, and for a wider range of applications compared to conventional ball nose tools.
- Select from a variety of flat bottom, back draft and toroid inserts for steep or straight wall milling with long extensions on hard to reach cores, cavities or fillets. Milling with small radii prevents deflection and results in superior finishes and contour accuracies. Available with or without chipbreaker and coating in a variety of corner radii and sizes.

Rock Solid Insert Clamping

Cutting insert clamping is highly accurate and rigid. Unique V-pocket design gives a truly positive seat for the insert and will not allow insert movement when milling with a side thrust. "Sandwiched" insert clamping with single locking screw is unsurpassed for rigidity. The advanced design of Millstar inserts eliminates heat-seizing of locking screws or insert movement due to costly locating screws or pins of less advanced design. Positive V-pocket seating eliminates mismatch when changing to fresh inserts. It also eliminates the need to program new length or diameter offsets.

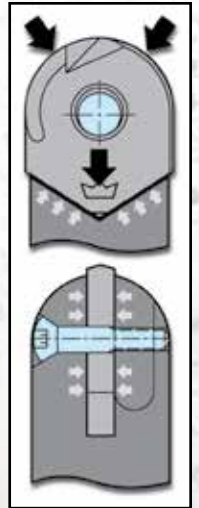

Ball Nose Inserts

MBT SuperFinisher Ball Nose Insert

Precision ground, harder grade, for semi-finish and finish milling. Excellent choice for unattended finish milling at small depth and high speeds and feed rates.



MB Ball Nose Insert

Unique cutting edge allows performance in all operations in material below 42 HRC; in semi, & finishing operations above. Significant benefits in chip evacuation. Insert geometry allows smoother cutting motion-diminishing heat build up & tool deflection, reduces vibration caused by cutting action.



VRBS Small Ball Nose Insert

Used for semi and finish-milling small radius or detail work, and surface milling in soft and hard steel, cast iron, aerospace and non-ferrous alloys, graphite, etc. Suitable for high speed and hard milling.



RB-N Ball Nose Insert

Precision ground, non-chipbreaker. Best choice for cavity, core and profile milling of pre-hard and fully hard die/mold steels, cast steels and cast iron. Strongest cutting edge design.



RBT Insert

Precision ground for semi-finish and finish milling. Excellent choice for unattended finish milling at small depth and high speed and feed rates.



BS-N Ball Nose Insert

Sidcutting, non-chipbreaker. Side cutting insert used in cavity and core profiling, for blending of fillets on medium and hard materials.



Flat Bottom Inserts

BDS Flat Bottom Insert

Precision ground, non-chipbreaker. Unique crossover design between flat bottom FB and back draft BD inserts. Allows straight walls with a larger step down than BD, but less cutting forces than FB; allows higher cutting speeds and feed

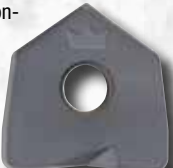

FB-R Flat Bottom Insert

Precision ground, with positive ground chipbreaker. Flat bottom insert for shoulder milling, fillet finishing and long reach angular wall finishing of softer materials



HF (High Feed) Inserts

Millstar's new HF insert is designed for High Speed and High Feed machining. The HF is designed to run at high cutting speeds and feed rates with shallow depth of cut. The NEW curved geometry allows the chip to flow up and out of the cut quickly and smoothly allowing for the use of heavy chip loads. The geometry of the new HF insert generates cutting forces upward, toward the spindle, which helps eliminate vibration and deflection, allowing for very high chip loads. The HF insert is designed to fit into Millstar's standard flat holders, style 4 (CYF, TAF and CBCYF) making these holders more versatile than ever.



Back Draft Inserts

BD-R Back Draft Insert

Precision ground, with positive ground chipbreaker and 7 degree back-taper. Used for milling of cores, cavities, fillets with straight or very steep walls of softer material.

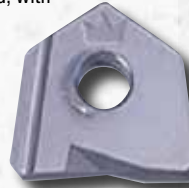

VBD Small Back Draft Insert

Used for semi and finish-milling small radius or detail work, and surface milling in soft and hard steel, cast iron, aerospace and non-ferrous alloys, aluminum alloys, graphite, etc. Suitable for high speed and hard milling.



BD-N Back Draft Insert

Precision ground, non-chipbreaker and 7 degree backtaper. Used for milling of cores, cavities, fillets with straight or very steep walls of harder material.

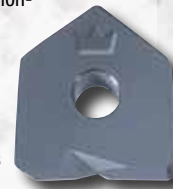

TOBD-NF Back Draft Inserts for Non-Ferrous Materials

Millstar's new TOBD-NF insert is specifically designed for high speed and high feed roughing of Aluminum, but also has the versatility to be used for fine finishing as well. This unique cutting edge design allows the chips to flow freely up the flute allowing higher speeds and feeds. The TOBD-NF comes in diameters from 1/2 inch (12mm) up to 1 inch (25mm) and fits into our standard flat type tool holders making the holders more versatile than ever.



CBN Tipped

For high speed machining or milling of high hardness materials with longer tool life and superior finishes.



PCD Tipped

For carbon milling with longer tool life.



Toroid

TO Toroid Bull Nose Insert

Precision ground, large corner radius & back taper for spiral and pocket milling, milling of pre-hard and hardened flat surfaces at higher speeds than tools with smaller corner radii. Good choice for HS milling of Aluminum

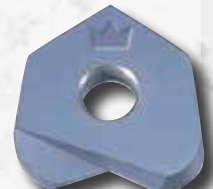

Holder Overview

Indexable Milling Holder Identification System

Measurement System	Denotes Shank Material	Shank Type	Diameter Size	Tool Body	
				Length	Diameter
Imperial	CB	SFCY	0500	-	6.0 - 0500
Metric	CB	SFCY	12	-	150 - 12
	"CB" = Carbide " " = Steel	SFCY = Cylindrical CY = Cylindrical Spike SFTA = Taper TA = Taper Spike	Imperial = Hundredths of an Inch Metric = Millimeters		Imperial = Inches Metric = Millimeters



The Tool Holders

Cylindrical and tapered toolholders include the longest reach profiling tools available as standard catalog items. Tool holders are inherently balanced for high spindle speeds. Machine with confidence at the increased speeds and velocities dictated by modern high velocity machining. Super intelligent machine controls with high speed data transfer, rapid advances in cutting edge materials and coating technologies enable ever faster machining speeds and increased productivity. Millstar tools are designed to keep pace.

Carbide Long Reach

Long Reach + Stiffness = High Speed Precision Milling MILLSTAR® Solid Carbide Long Reach Tool Shanks and Precision Profile Milling Inserts are designed for aggressive and high speed milling of a wide variety of materials. They provide the perfect solution for difficult milling operations in die and mold making, aerospace and many other demanding applications requiring fast metal removal rates, precision tolerances and smoothest surface finishes.

User benefits:

- Increased stiffness – for more aggressive metal removal and long reach, deep milling.
- Large cutting insert choice – the variety of available cutting geometry, tool coatings, and insert shapes and sizes assures best milling results at lowest machining cost per part.
- Minimized deflection – to machine closer to net shape & tight tolerance.
- Vibration reducing – for smoother surface finish, improved tool life, longer spindle life.

- Minimized cutter run out – improved milling results in soft to fully hardened (to 65 HRc) materials.
- Smaller shank to cutter diameter – several sizes have full-length side clearance to machine straight walls.
- Safe high speed milling – highest tool stiffness and least deflection when compared with steel and heavy metal tool shanks result in process reliability and highest safety for operator and machine.
- Shank diameters (h6) – all tool shanks are heat shrink-fit tool adapter compatible.

Button Cutter

High Performance Milling from Heavy Roughing to Fine Finishing.

Millstar face mills are equally useful on newer high velocity machines and older slower equipment and will optimize milling performance of all your machine tools. The hardened tool bodies can be run at aggressive spindle speed and feed rates, when used with Millstar's precision ground, strong and thick, round inserts with proven hard, high performance TLN or HSN tool coating.

The tools provide for precision finish results, minimal tool deflection and run-out. Excellent milling results can be achieved in roughing, semi finishing and fine finishing in Z-level, profiling or raster cuts, as well as in linear or circular interpolation milling or ramping.

The tools may be used with coolant, but we recommend dry, mist or MQL (minimum quantity lubrication) milling with strong air blast when high speed or hard machining steel, particularly in the higher hardness range (> 45HRc / 425 HBN). Please refer to FAQs (frequently asked questions) about milling on our website www.millstar.com.





Profile Milling Program Tool Contents

VRBS, MBT, VBD,/BDS	Graphite Machining Program	8-9	
SFCY	Cylindrical Steel Shank Holder – Ball	10	
SFTA	Taper Steel Shank Holder – Ball	10	
CYF	Cylindrical Steel Shank Holder – Flat	11	
TAF	Taper Steel Shank Holder – Flat	11	
TAV, CY, TA	Spike-Line Cylindrical Steel Shank	12	
CB SFCY	Cylindrical Carbide Shank Holder – Ball	12	
CB CYF	Cylindrical Carbide Shank Holder – Flat	13	
CB TAV	Spike-Line Taper Carbide Shank Holder – Ball & Flat	13	
CB TA	Taper Carbide Uni-Shank Holder – Ball & Flat	13	
SF CY/CYF	Screw-on Head – Ball & Flat	15	
Solid Carbide Adaptor		15	
Inserts		16-21	
Cutting Parameters		20-21	
Verify Surface Roughness		22	
Feed & Speed Calculator		23	

Profile Milling Program Tools

Millstar Profile Milling Tools represent the latest in profile and contour milling technology, providing the competitive edge of shorter machining and lead times, and the advantages of higher machining accuracy and true contouring results.

The Millstar Advantage

Better surface finishes	=	Reduced finishing work
Faster run & feed speed	=	Reduced machining time
Increased tool life	=	Reduced tool changes & cost
Accurate and consistent milling	=	Reduced manual rework
Balanced milling action, two flute efficiency	=	Greatly increased metal removal productivity



Graphite Machining Program - True Diamond Coated Inserts

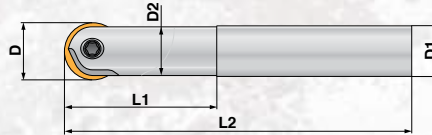

VRBS/RB - General Ball Nose Graphite Machining Line, Inch

Tool Ordering Number	Dimensions					Recommended Shank Part Number
	Size ØD	Shank ØD1	Neck ØD2	Neck Length L1	Total Length L2	
VRBS-0250-DMD	0.250	0.250	NA	NA	6.000	CBCYV-0250-6.0-0250
VRBS-0312-DMD	0.312	0.312	NA	NA	6.000	CBCYV-0312-6.0-0312
RB-0375-N-DMD	0.375	0.375	0.337	1.145	6.000	CBCY-0375-6.0-0375
RB-0500-N-DMD	0.500	0.500	0.440	1.145	6.000	CBSFCY-0500-6.0-0500
RB-0500-N-DMD	0.500	12mm	0.440	1.145	6.000	CBSFCY-0500-6.0-12
RB-0625-N-DMD	0.625	0.625	0.550	1.325	6.000	CBSFCY-0625-6.0-0625
RB-0750-N-DMD	0.750	0.750	0.675	1.500	8.000	CBSFCY-0750-8.0-0750
RB-0750-N-DMD	0.750	18mm	0.675	1.500	8.000	CBSFCY-0750-8.0-18
RB-1000-N-DMD	1.000	1.000	0.882	1.866	8.000	CBSFCY-1000-8.0-1000
RB-1000-N-DMD	1.000	25mm	0.882	1.866	8.000	CBSFCY-1000-8.0-25

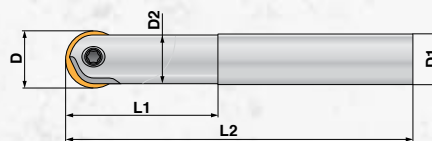

MBT - Ball Nose Graphite Finishing Line, Inch

Tool Ordering Number	Dimensions					Recommended Shank Part Number
	Size ØD	Shank ØD1	Neck ØD2	Neck Length L1	Total Length L2	
MBT-0375-DMD	0.375	0.375	0.337	1.145	6.000	CBCY-0375-6.0-0375
MBT-0500-DMD	0.500	0.500	0.440	1.145	6.000	CBSFCY-0500-6.0-0500
MBT-0500-DMD	0.500	12mm	0.440	1.145	6.000	CBSFCY-0500-6.0-12
MBT-0625-DMD	0.625	0.625	0.550	1.325	6.000	CBSFCY-0625-6.0-0625
MBT-0750-DMD	0.750	0.750	0.675	1.500	8.000	CBSFCY-0750-8.0-0750
MBT-0750-DMD	0.750	18mm	0.675	1.500	8.000	CBSFCY-0750-8.0-18
MBT-1000-DMD	1.000	1.000	0.882	1.866	8.000	CBSFCY-1000-8.0-1000
MBT-1000-DMD	1.000	25mm	0.882	1.866	8.000	CBSFCY-1000-8.0-25

* For other holder options, see page 10 (Inch).

Graphite Machining Program - True Diamond Coating or PCD Tipped

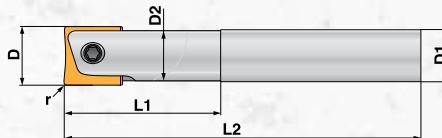
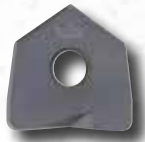

VBD/BDS - Flat Bottom Graphite Machining Line, Inch

Tool Ordering Number	Dimensions						Recommended Shank Part Number
	Size ØD	Radius	Shank ØD1	Neck ØD2	Neck Length L1	Total Length L2	
VBD-0250-R01-	0.250	0.015	0.250	NA	NA	6.000	CBCYV-0250-6.0-0250
VBD-0312-R01-	0.312	0.015	0.312	NA	NA	6.000	CBCYV-0312-6.0-0312
BDS-0375-N02-	0.375	0.031	0.375	0.337	1.145	6.000	CBCY-0375-6.0-0375
BDS-0375-N04-	0.375	0.062	0.375	0.337	1.145	6.000	CBCY-0375-6.0-0375
BDS-0500-N01-	0.500	0.015	0.500	0.440	1.145	6.000	CBCYF-0500-6.0-0500
BDS-0500-N02-	0.500	0.031	0.500	0.440	1.145	6.000	CBCYF-0500-6.0-0500
BDS-0500-N04-	0.500	0.062	0.500	0.440	1.145	6.000	CBCYF-0500-6.0-0500
BDS-0500-N01-	0.500	0.015	12mm	0.440	1.145	6.000	CBCYF-0500-6.0-12
BDS-0500-N02-	0.500	0.031	12mm	0.440	1.145	6.000	CBCYF-0500-6.0-12
BDS-0500-N04-	0.500	0.062	12mm	0.440	1.145	6.000	CBCYF-0500-6.0-12
BDS-0625-N02-	0.625	0.031	0.625	0.550	1.325	6.000	CBCYF-0625-6.0-0625
BDS-0625-N04-	0.625	0.062	0.625	0.550	1.325	6.000	CBCYF-0625-6.0-0625
BDS-0750-N02-	0.750	0.031	0.750	0.675	1.500	8.000	CBCYF-0750-8.0-0750
BDS-0750-N04-	0.750	0.062	0.750	0.675	1.500	8.000	CBCYF-0750-8.0-0750
BDS-0750-N08-	0.750	0.125	0.750	0.675	1.500	8.000	CBCYF-0750-8.0-0750
BDS-0750-N02-	0.750	0.031	18mm	0.675	1.512	8.000	CBCYF-0750-8.0-18
BDS-0750-N04-	0.750	0.062	18mm	0.675	1.512	8.000	CBCYF-0750-8.0-18
BDS-0750-N08-	0.750	0.125	18mm	0.675	1.512	8.000	CBCYF-0750-8.0-18
BDS-1000-N02-	1.000	0.031	1.000	0.820	1.866	8.000	CBCYF-1000-8.0-1000
BDS-1000-N04-	1.000	0.062	1.000	0.820	1.866	8.000	CBCYF-1000-8.0-1000
BDS-1000-N08-	1.000	0.125	1.000	0.820	1.866	8.000	CBCYF-1000-8.0-1000
BDS-1000-N02-	1.000	0.031	25mm	0.820	1.866	8.000	CBCYF-1000-8.0-25
BDS-1000-N04-	1.000	0.062	25mm	0.820	1.866	8.000	CBCYF-1000-8.0-25
BDS-1000-N08-	1.000	0.125	25mm	0.820	1.866	8.000	CBCYF-1000-8.0-25

All products on these pages come in both PCD Tipped and Diamond Coated (DMD).

Examples: VBD-0250-R01-DMD
BDS-0375-N02-PCD

* For other holder options, see page 10 (Inch).

Profile Milling Holders

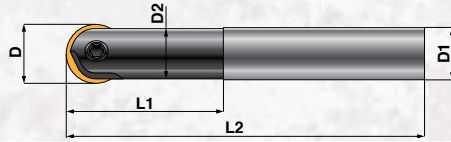

SFCY - Cylindrical Steel Shank Holder, Ball

Tool Ordering Number	Dimensions					Screw	Key	Use with Inserts	
	Size ØD	Shank ØD1	Neck ØD2	Neck Length L1	Total Length L2			Type	Code
SFCY-0500-4.0-0500	0.500	0.500	0.440	1.250	4.000	MS12	T20		MB, MBT, RB-N, BS-N, RBT
SFCY-0500-5.0-0500	0.500	0.500	0.440	1.500	5.000	MS12	T20		
SFCY-0500-6.0-0500	0.500	0.500	0.440	1.750	6.000	MS12	T20		
SFCY-0500-6.0-12	0.500	12mm	0.440	1.750	6.000	MS12	T20		
SFCY-0625-5.0-0625	0.625	0.625	0.550	1.375	5.000	MS16	T20		
SFCY-0625-6.25-0625	0.625	0.625	0.550	2.000	6.250	MS16	T20		
SFCY-0750-4.5-0750	0.750	0.750	0.675	1.750	4.500	MS20	T20		
SFCY-0750-6.0-0750	0.750	0.750	0.675	2.000	6.000	MS20	T20		
SFCY-0750-7.5-0750	0.750	0.750	0.675	2.375	7.500	MS20	T20		
SFCY-0750-9.0-0750	0.750	0.750	0.675	2.375	9.000	MS20	T20		
SFCY-1000-6.0-1000	1.000	1.000	0.882	1.750	6.000	MS25	T20		
SFCY-1000-6.0-25	1.000	25mm	0.882	1.750	6.000	MS25	T20		
SFCY-1000-8.0-1000	1.000	1.000	0.882	2.500	8.000	MS25	T20		
SFCY-1000-10.0-1000	1.000	1.000	0.882	2.750	10.000	MS25	T20		
SFCY-1000-10.0-25	1.000	25mm	0.882	2.750	10.000	MS25	T20		
SFCY-1250-7.5-1250	1.250	1.250	1.125	2.250	7.500	MS32	T30		
SFCY-1250-10.0-1250	1.250	1.250	1.125	3.000	10.000	MS32	T30		

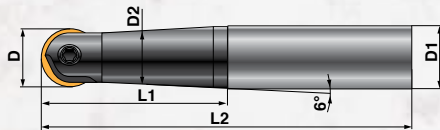

SFTA - Taper Steel Shank Holder, Ball

Tool Ordering Number	Dimensions					Screw	Key	Use with Inserts	
	Size ØD	Shank ØD1	Neck ØD2	Neck Length L1	Total Length L2			Type	Code
SFTA-0500-7.5-0625	0.500	0.625	0.440	2.000	7.500	MS 12	T20		MB, MBT, RB-N, BS-N, RBT
SFTA-0625-7.5-0750	0.625	0.750	0.550	2.250	7.500	MS 16	T20		
SFTA-0750-8.0-1000	0.750	1.000	0.675	3.500	8.000	MS 20	T20		
SFTA-0750-10.0-1000	0.750	1.000	0.675	3.500	10.000	MS 20	T20		
SFTA-1000-10.0-1250	1.000	1.250	0.882	4.000	10.000	MS 25	T20		
SFTA-1000-12.5-1250	1.000	1.250	0.882	4.000	12.500	MS 25	T20		
SFTA-1000-15.0-1250	1.000	1.250	0.882	4.000	15.000	MS 25	T20		
SFTA-1250-9.0-1500	1.250	1.500	1.125	4.000	9.000	MS 32	T30		
SFTA-1250-12.0-1500	1.250	1.500	1.125	4.000	12.000	MS 32	T30		

Profile Milling Holders

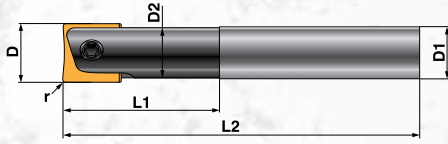

CYF - Cylindrical Steel Shank Holder, Flat

Tool Ordering Number	Dimensions					Screw	Key	Use with Inserts	
	Size ØD	Shank ØD1	Neck ØD2	Neck Length L1	Total Length L2			Type	Code
CYF-0375-4.0-0375	0.375	0.375	0.337	0.750	4.000	MS 10	T15		BD-N, BD-R, BDS, FB-R, TO, TOBD-NF, HF
CYF-0500-4.0-0500	0.500	0.500	0.440	1.250	4.000	MS 12	T20		
CYF-0500-6.0-0500	0.500	0.500	0.440	1.750	6.000	MS 12	T20		
CYF-0500-6.0-12	0.500	12mm	0.440	1.750	6.000	MS 12	T20		
CYF-0625-6.25-0625	0.625	0.625	0.550	2.000	6.250	MS 16	T20		
CYF-0750-6.0-0750	0.750	0.750	0.675	2.000	6.000	MS 20	T20		
CYF-0750-9.0-0750	0.750	0.750	0.675	2.375	9.000	MS 20	T20		
CYF-0750-9.0-18	0.750	18mm	0.675	2.375	9.000	MS 20	T20		
CYF-1000-6.0-1000	1.000	1.000	0.882	1.750	6.000	MS 25	T20		
CYF-1000-6.0-25	1.000	25mm	0.882	1.750	6.000	MS 25	T20		
CYF-1000-8.0-1000	1.000	1.000	0.882	2.500	8.000	MS 25	T20		
CYF-1000-10.0-1000	1.000	1.000	0.882	2.750	10.000	MS 25	T20		
CYF-1000-10.0-25	1.000	25mm	0.882	2.750	10.000	MS 25	T20		
CYF-1250-7.5-1250	1.250	1.250	1.125	2.250	7.500	MS 32	T30		
CYF-1250-10.0-1250	1.250	1.250	1.125	3.000	10.000	MS 32	T30		

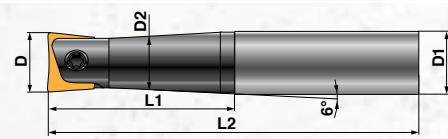

TAF - Taper Steel Shank Holder, Flat

Tool Ordering Number	Dimensions					Screw	Key	Use with Inserts	
	Size ØD	Shank ØD1	Neck ØD2	Neck Length L1	Total Length L2			Type	Code
TAF-0375-6.0-0500	0.375	0.500	0.337	1.750	6.000	MS 10	T15		BD-N, BD-R, BDS, FB-R, TO, TOBD-NF, HF
TAF-0500-7.5-0625	0.500	0.625	0.440	2.000	7.500	MS 12	T20		
TAF-0625-7.5-0750	0.625	0.750	0.550	2.250	7.500	MS 16	T20		
TAF-0750-10.0-1000	0.750	1.000	0.675	3.500	10.000	MS 20	T20		
TAF-1000-10.0-1250	1.000	1.250	0.882	4.000	10.000	MS 25	T20		
TAF-1000-12.5-1250	1.000	1.250	0.882	4.000	12.500	MS 25	T20		
TAF-1000-15.0-1250	1.000	1.250	0.882	4.000	15.000	MS 25	T20		
TAF-1250-9.0-1500	1.250	1.500	1.125	4.000	9.000	MS 32	T30		
TAF-1250-12.0-1500	1.250	1.500	1.125	4.000	12.000	MS 32	T30		

Profile Milling Holders

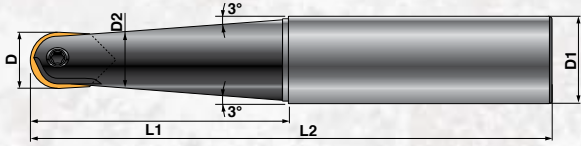

TAV, CY, TA - Spike-Line Cylindrical Steel Shank

Tool Ordering Number	Dimensions					Screw	Key	Use with Inserts	
	Size ØD	Shank ØD1	Neck ØD2	Neck Length L1	Total Length L2			Type	Code
TAV-0250-3.75-0500	0.250	0.500	0.225	1.250	3.750	MS06N	T7		VRBS, VBD
TAV-0312-3.75-0500	0.3125	0.500	0.281	1.250	3.750	MS08N	T7		VRBS, VBD
CY-0375-4.0-0375	0.375	0.375	0.337	0.750	4.000	MS10	T15		MB, MBT, RB-N, BS-N, BD, BDS, FB, TO, HF, RBT
CY-0375-4.0-0500	0.375	0.500	0.337	1.000	4.000	MS10	T15		MB, MBT, RB-N, BS-N, BD, BDS, FB, TO, HF, RBT
TA-0375-6.0-0500	0.375	0.500	0.337	1.750	6.000	MS10	T15		MB, MBT, RB-N, BS-N, BD, BDS, FB, TO, HF, RBT

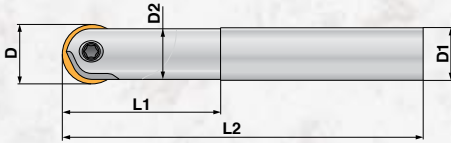

CB SFCY - Cylindrical Carbide Shank Holder, Ball

Tool Ordering Number	Dimensions					Screw	Key	Use with Inserts	
	Size ØD	Shank ØD1	Neck ØD2	Neck Length L1	Total Length L2			Type	Code
CBCYV-0250-6.0-0250	0.250	0.250	0.220	1.100	6.000	MS06N	T7		VRBS, VBD
CBCYV-0312-6.0-0312	0.312	0.312	0.280	1.100	6.000	MS08N	T7		VRBS, VBD
CBCY-0375-4.0-0375	0.375	0.375	0.337	1.145	4.000	MS10	T15		MB, MBT, RB-N, BS-N, RBT
CBCY-0375-6.0-0375	0.375	0.375	0.337	1.145	6.000	MS10	T15		
CBSFCY-0500-6.0-0500	0.500	0.500	0.440	1.145	6.625	MS12	T20		
CBSFCY-0500-6.0-12	0.500	12mm	0.440	1.145	6.625	MS12	T20		
CBSFCY-0625-6.0-0625	0.625	0.625	0.550	1.325	6.750	MS16	T20		
CBSFCY-0750-8.0-18	0.750	18mm	0.675	1.500	8.875	MS20	T20		
CBSFCY-0750-8.0-0750	0.750	0.750	0.675	1.512	8.875	MS20	T20		
CBSFCY-1000-8.0-1000	1.000	1.000	0.882	1.866	9.125	MS25	T20		
CBSFCY-1000-8.0-25	1.000	25mm	0.882	1.866	9.125	MS25	T20		

Profile Milling Holders

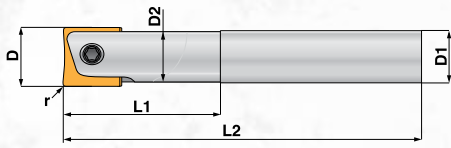

CB CYF - Cylindrical Carbide Shank Holder, Flat

Tool Ordering Number	Dimensions					Screw	Key	Use with Inserts	
	Size ØD	Shank ØD1	Neck ØD2	Neck Length L1	Total Length L2			Type	Code
CBCY-0375-4.0-0375	0.375	0.375	0.337	1.145	4.000	MS10	T15		BD-N, BD-R, BDS, FB-R, TO, TOBD-NF, HF
CBCY-0375-6.0-0375	0.375	0.375	0.337	1.145	6.000	MS10	T15		
CBCYF-0500-6.0-0500	0.500	0.500	0.440	1.145	6.625	MS12	T20		
CBCYF-0500-6.0-12	0.500	12mm	0.440	1.145	6.625	MS12	T20		
CBCYF-0625-6.0-0625	0.625	0.625	0.550	1.325	6.750	MS16	T20		
CBCYF-0750-8.0-18	0.750	18mm	0.675	1.500	8.875	MS20	T20		
CBCYF-0750-8.0-0750	0.750	0.750	0.675	1.512	8.875	MS20	T20		
CBCYF-1000-8.0-1000	1.000	1.000	0.820	1.866	9.125	MS25	T20		
CBCYF-1000-8.0-25	1.000	25mm	0.882	1.866	9.125	MS25	T20		

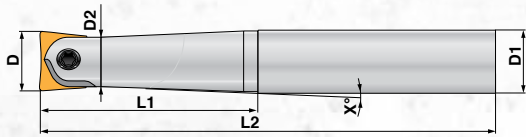

CB TAV - Spike-Line Taper Carbide Shank, Ball & Flat

Tool Ordering Number	Dimensions					X°	Screw	Key	Use with Inserts	
	Size ØD	Shank ØD1	Neck ØD2	Neck Length L1	Total Length L2				Type	Code
CBTAV-0250-6.0-0500	0.250	0.500	0.224	1.181 taper	6.125	6° (3°/side)	MS06N	T7		VRBS, VBD
CBTAV-0250-6.0-0500 LT	0.250	0.500	0.224	2.750 taper	6.125	6° (3°/side)	MS06N	T7		
CBTAV-0312-6.0-0500	0.312	0.500	0.285	1.181 taper	6.125	6° (3°/side)	MS08N	T7		

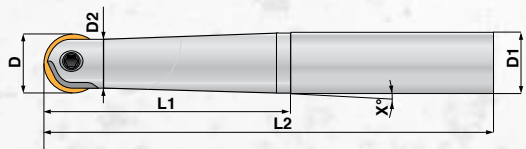

CB TA - Taper Carbide Uni-Shank Holder, Ball & Flat

Tool Ordering Number	Dimensions					X°	Screw	Key	Use with Inserts	
	Size ØD	Shank ØD1	Neck ØD2	Neck L1	Total L2				Type	Code
CBTA-0375-6.0-0500	0.375	0.500	0.337	1.181 taper	6.125	6° (3°/side)	MS10	T15		MB, MBT, RB-N, BS-N, BD, BDS, FB, TO, HF, RBT

MILLSTAR.

Screw-On Heads



Modular Screw-On System

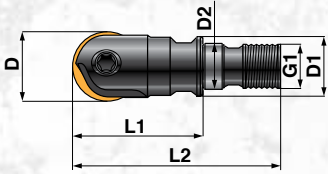

SF CY - Screw-on Head, Ball

Tool Ordering Number	Size ØD	Diameter D1	Diameter D2	Thread G1	Length L1	Length L2	Fits Shank Ø	Use with Inserts	
								Type	Code
SFCY-0500-SC-M6	0.500	0.444	0.256	M6	1.00	1.70	0.500/12mm		MB, MBT, RB-N, BS-N, RBT
SFCY-0625-SC-M8	0.625	0.566	0.335	M8	1.25	1.95	0.625/16mm		
SFCY-0750-SC-M10	0.750	0.678	0.414	M10	1.40	2.22	0.750/20mm		
SFCY-1000-SC-M12	1.000	0.886	0.492	M12	1.71	2.58	1.000/25mm		

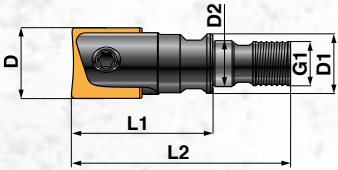

CYF - Screw-on Head, Flat

Tool Ordering Number	Size ØD	Diameter D1	Diameter D2	Thread G1	Length L1	Length L2	Fits Shank Ø	Use with Inserts	
								Type	Code
CYF-0500-SC-M6	0.508	0.444	0.256	M6	1.00	1.70	0.500/12mm		BD-N, BD-R, BDS, FB-R, TO, TOBD-NF, HF
CYF-0625-SC-M8	0.625	0.566	0.335	M8	1.25	1.95	0.625/16mm		
CYF-0750-SC-M10	0.750	0.678	0.414	M10	1.40	2.22	0.750/20mm		
CYF-1000-SC-M12	1.000	0.886	0.492	M12	1.71	2.58	1.000/25mm		

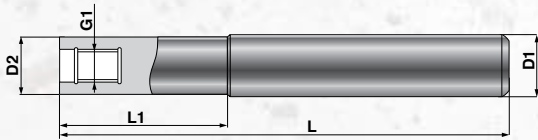

Solid Carbide Adaptor

Tool Ordering Number	Dimensions				Thread G1
	Size ØD1	Neck ØD2	Neck L1	Total L	
CY-0375-6.0-SC-M6	0.375	-	-	6.000	M6
CY-0500-6.0-SC-M6	0.500	-	-	6.000	M6
CY-0625-6.0-SC-M8	0.625	-	-	6.000	M8
CY-0750-8.0-SC-M10	0.750	-	-	8.000	M10
CY-1000-4.0-SC-M12	1.000	-	-	4.000	M12
CY-1000-7.0-SC-4.1-M12-CH	1.000	0.945	4.10	7.000	M12
CY-1000-10.0-SC-M12	1.000	-	-	10.000	M12

Profile Milling Inserts

Small Ball Nose & Back Draft Inserts

VRBS	Tool Ordering Number	Dimensions			Grade			Description
		D	L	R	XRN	TLN	HSN	
	VRBS-0250	0.250	0.294	0.125	•	•	•	Used for semi and finish-milling small radius or detail work, and surface milling in soft and hard steel, cast iron, aerospace and non-ferrous alloys, graphite, etc. Suitable for high speed and hard milling.
	VRBS-0312	0.312	0.184	0.156	•	•	•	
VBD	Tool Ordering Number	Dimensions			Grade			Description
		D	L	R	XRN	TLN	HSN	
	VBD-0250-R01	0.250	0.313	0.015	•	•	•	Used for semi and finish-milling small radius or detail work, and surface milling in soft and hard steel, cast iron, aerospace and non-ferrous alloys, graphite, etc. Suitable for high speed and hard milling.
	VBD-0312-R01	0.312	0.215	0.015	•	•	•	

High Feed Inserts

HF	Tool Ordering Number	Dimensions			Grade			Description
		D	L	PR	XRN	TLN	HSN	
	HF-0375...	0.375	0.0125	0.028	•	•	•	Millstar HF insert is designed for High feed and High speed machining. It runs at high cutting speed and feed rates with shallow depth of cut. It allows the chip to flow up and out of the cut quickly. It allows heavy chip loads.
	HF-0500...	0.500	0.0203	0.052	•	•	•	
	HF-0625...	0.625	0.0235	0.071	•	•	•	
	HF-0750...	0.750	0.0315	0.094	•	•	•	
	HF-1000...	1.000	0.0345	0.111	•	•	•	

Cutting Recommendations for High Feed Inserts

Work Material	Material Hardness	Cutting Depth at Diameter ap max						Cutting Width	Insert	Coating Type Recom.	Cut speed at D sfm/min	Max feed per tooth fz at cutting insert diameter D				
		0.375	0.500	0.625	0.750	1.000	Ae max					0.375	0.500	0.625	0.750	1.000
H13/1.2344/ SKD61	<41	0.014	0.019	0.023	0.028	0.037	60 - 75%	HF	XRN/HSN	515 - 715	0.012~0.016	0.017~0.021	0.021~0.025	0.026~0.030	0.035~0.039	
H13/1.2344/ SKD61	41-50	0.012	0.016	0.019	0.023	0.031	60 - 75%	HF	XRN/HSN	415 - 615	0.010~0.014	0.014~0.018	0.017~0.021	0.021~0.025	0.029~0.033	
H13/1.2344/ SKD61	51+	0.009	0.013	0.016	0.019	0.025	60 - 75%	HF	HSN	315 - 515	0.007~0.011	0.011~0.015	0.014~0.018	0.017~0.021	0.023~0.027	
A2/1.2363/ SKD12	<41	0.014	0.019	0.023	0.028	0.037	60 - 75%	HF	XRN/HSN	515 - 715	0.012~0.016	0.017~0.021	0.021~0.025	0.026~0.030	0.035~0.039	
A2/1.2363/ SKD12	14-50	0.012	0.016	0.019	0.023	0.0319	60 - 75%	HF	XRN/HSN	415 - 615	0.010~0.014	0.014~0.018	0.017~0.021	0.021~0.025	0.029~0.033	
A2/1.2363/ SKD12	51+	0.009	0.013	0.016	0.019	0.025	60 - 75%	HF	HSN	315 - 515	0.007~0.011	0.011~0.015	0.014~0.018	0.017~0.021	0.023~0.027	
P20/1.2330	<41	0.014	0.019	0.023	0.028	0.037	60 - 75%	HF	XRN/HSN	515 - 715	0.012~0.016	0.017~0.021	0.021~0.025	0.026~0.030	0.035~0.039	
P20/1.2330	14-50	0.012	0.016	0.019	0.023	0.031	60 - 75%	HF	XRN/HSN	415 - 615	0.010~0.014	0.014~0.018	0.017~0.021	0.021~0.025	0.029~0.033	
D2/1.2379/ SKD11	<41	0.014	0.019	0.023	0.028	0.037	60 - 75%	HF	XRN/HSN	515 - 715	0.012~0.016	0.017~0.021	0.021~0.025	0.026~0.030	0.035~0.039	
D2/1.2379/ SKD11	14-50	0.012	0.016	0.019	0.023	0.031	60 - 75%	HF	XRN/HSN	415 - 615	0.010~0.014	0.014~0.018	0.017~0.021	0.021~0.025	0.029~0.033	
D2/1.2379/ SKD11	51+	0.009	0.013	0.016	0.019	0.025	60 - 75%	HF	HSN	315 - 515	0.007~0.011	0.011~0.015	0.014~0.018	0.017~0.021	0.023~0.027	
Grey Cast Iron/ GG	<41	0.014	0.019	0.023	0.028	0.037	60 - 75%	HF	XRN/HSN	515 - 715	0.012~0.016	0.017~0.021	0.021~0.025	0.026~0.030	0.035~0.039	
Cast Iron/GGG	41+	0.012	0.016	0.019	0.023	0.031	60 - 75%	HF	XRN/HSN	515 - 715	0.012~0.016	0.017~0.021	0.021~0.025	0.026~0.030	0.035~0.039	

Copy Milling Inserts

Flat Bottom, Back Draft, Toroid

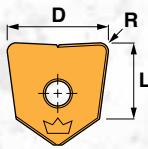
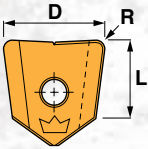
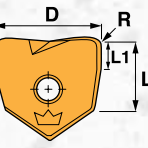
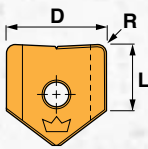
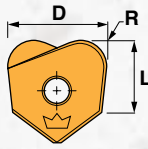
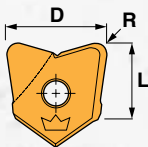
BD-N	Tool Ordering Number	Dimensions			Grade			Description	
		D	L	R	XRN	TLN	HSN		
	BD-0375-N	0.375	0.357	1/32,1/16	•	•	•	Precision ground with 7° back taper. Used for milling of cores, cavities, fillets with straight or very steep walls of harder materials.	
	BD-0500-N	0.500	0.380	1/32,1/16	•	•	•		
	BD-0625-N	0.625	0.457	1/32,1/16	•	•	•		
	BD-0750-N	0.750	0.540	1/32,1/16,1/8	•	•	•		
	BD-1000-N	1.000	0.740	1/32,1/16,1/8	•	•	•		
	BD-1250-N	1.250	0.919	1/32,1/16,1/8	•	•	•		
BD-R	Number	D	L	R	XRN	TLN	HSN	Description	
	BD-0375-R	0.375	0.340	1/32	•	•	•	Precision ground with positive ground chip-breaker and 7° back taper. Used for milling of cores, cavities, fillets with straight or very steep walls of softer materials.	
	BD-0500-R	0.500	0.380	1/32,1/16,1/8	•	•	•		
	BD-0625-R	0.625	0.457	1/32,1/16	•	•	•		
	BD-0750-R	0.750	0.540	1/32,1/16,1/8	•	•	•		
	BD-1000-R	1.000	0.740	1/32,1/16,1/8	•	•	•		
	BD-1250-R	1.250	0.919	1/32,1/16,1/8	•	•	•		
BDS	Number	D	L	R	L1	XRN	TLN	HSN	Description
	BDS-0375-N	0.375	0.340	1/32,1/16	0.125	•	•	•	Precision ground with unique crossover design between flat bottom FB and back draft DB inserts. Allows straight walls with a larger step down than BD. Allows higher cutting speeds and feeds.
	BDS-0500-N	0.500	0.380	015,1/32,1/16	0.125	•	•	•	
	BDS-0625-N	0.625	0.457	1/32,1/16	0.125	•	•	•	
	BDS-0750-N	0.750	0.540	1/32,1/16,1/8	0.125	•	•	•	
	BDS-1000-N	1.000	0.740	1/32,1/16,1/8	0.125	•	•	•	
	BDS-1250-N	1.250	0.919	1/16	0.125	•	•	•	
FB-R	Number	D	L	R	XRN	TLN	HSN	Description	
	FB-0375-R	0.375	0.341	1/32	•	•	•	Precision ground with positive ground chip-breaker. Flat bottom inserts for shoulder milling, fillet finishing and long reach angular wall finishing of softer materials.	
	FB-0500-R	0.500	0.350	1/32,1/16,1/8	•	•	•		
	FB-0625-R	0.625	0.421	1/32,1/16	•	•	•		
	FB-0750-R	0.750	0.496	1/32,1/16,1/8	•	•	•		
	FB-1000-R	1.000	0.679	1/32,1/16,1/8	•	•	•		
	FB-1250-R	1.250	0.843	1/32,1/16,1/8	•	•	•		
TO	Number	D	L	R	XRN	TLN	HSN	Description	
	TO-0375	0.375	0.349	0.125	•	•	•	Precision ground large corner radius & back taper for spiral and pocket milling. Milling of pre-hard and hardened flat surfaces at higher speeds than tools with smaller corner radii. Good choice for HS milling of Aluminum.	
	TO-0500	0.500	0.377	0.125	•	•	•		
	TO-0625	0.625	0.433	0.156	•	•	•		
	TO-0750	0.750	0.518	0.187	•	•	•		
	TO-1000	1.000	0.716	0.250	•	•	•		
	TO-1250	1.250	0.865	0.312	•	•	•		
TOBD-NF	Number	D	L	R	XRN	TLN	HSN	Description	
	TOBD-0500-NF	0.500	0.377	0.125				Millstar inserts designed for high speed high feed roughing of Aluminum, but also has the versatility to be used for fine finishing as well.	
	TOBD-0625-NF	0.625	0.433	0.125					
	TOBD-0750-NF	0.750	0.518	0.125					
	TOBD-1000-NF	1.000	0.716	0.125					

Radius Ordering Numbers:

For .015 use ordering # .015 • For 1/32" use ordering # 02 1/16" use ordering # 04
For 1/8" use ordering # 08

Example: 1/2" BDS-0500N-04-HSN

NA

Non-coated grade.

XRN

Multi-layer hybrid coating of AlCrN. This coating has very good heat resistance and also a low friction coefficient. The XRN coating is designed for use in HSM of un-heat treated softer materials such as Titanium, Inconel, Stainless Steels and other gummy materials that require the use of liquid coolant.

HSN

Millstar's new coating is a multi-layer hybrid Nano coating. This new coating has very good heat resistance and high hardness. The HSN coating is designed for use in HSM of Heat Treated materials up to 72 HRC.

ALTiN-EXALON (TLN)

Titanium Aluminum Nitride advanced PVD coating. A special, improved ALTiN coating approaching surface hardness of CBN on a tough substrate. Recommended for tough and hard metal machining applications.

DMD

Diamond coating. Custom coating for cutting non-ferrous, non-metallic and very abrasive materials at highly elevated speeds. Use on copper, bronze, brass, aluminum-silicon alloys, carbon graphite, solid and fiber-reinforced plastics, ceramics and composite materials.

Custom tool coatings for specific applications are available by request.

BDS Series in PCD and CBN Tipped

Back Draft

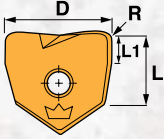
BDS	Tool Ordering Number	Dimensions				Grade			Description
		D	L	R	L1	XRN	TLN	HSN	
	BDS-0375-N	0.375	0.340	1/32,1/16	0.125	•	•	•	Precision ground with unique crossover design between flat bottom FB and back draft BD inserts. Allows straight walls with a larger step down than BD. Allows higher cutting speeds and feeds.
	BDS-0500-N	0.500	0.380	015,1/32,1/16	0.125	•	•	•	
	BDS-0625-N	0.625	0.457	1/32,1/16	0.125	•	•	•	
	BDS-0750-N	0.750	0.540	1/32,1/16,1/8	0.125	•	•	•	
	BDS-1000-N	1.000	0.740	1/32,1/16,1/8	0.125	•	•	•	

PCD Tipped

For carbon milling with longer tool life

CBN Tipped

For high speed machining or milling of high hardness materials with longer tool life and superior finishes.



NEW!
Higher cutting speeds and feeds with new Back Draft Tools

Radius Ordering Numbers:

For .015 use ordering # .015 • For 1/32" use ordering # 02 1/16" use ordering # 04
For 1/8" use ordering # 08

Example: 1/2" BDS-0500N-04-PCD or CBN

Copy Milling Inserts

Ball Nose Inserts

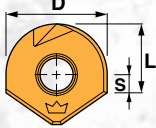
BS-N	Tool Ordering Number	Dimensions			Grade			Description
		D	L	S	XRN	TLN	HSN	
	BS-0375-N	0.375	0.390	0.154	•	•	•	Sidecutting, non-chipbreaker. Side cutting insert used in cavity and core profiling, for blending of fillets on medium and hard materials.
	BS-0500-N	0.500	0.350	0.100	•	•	•	
	BS-0625-N	0.625	0.421	0.109	•	•	•	
	BS-0750-N	0.750	0.496	0.121	•	•	•	
	BS-1000-N	1.000	0.679	0.179	•	•	•	
	BS-1250-N	1.250	0.828	0.203	•	•	•	

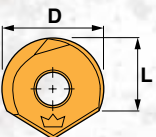
MB	Number	D	L	Grade			Description
				XRN	TLN	HSN	
	MB-0375	0.375	0.349	•	•	•	Unique cutting edge allows performance in all operations in material below 42 HRC; in semi- & finishing operations above. Significant benefits in chip evacuation. Insert geometry allows smoother cutting motion-diminishing heat build up & tool deflection, reduces vibration caused by cutting action.
	MB-0500	0.500	0.377	•	•	•	
	MB-0625	0.625	0.443	•	•	•	
	MB-0750	0.750	0.518	•	•	•	
	MB-1000	1.000	0.716	•	•	•	
	MB-1250	1.250	0.865	•	•	•	

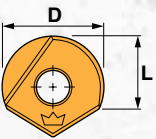
MBT	Number	D	L	Grade			Description
				XRN	TLN	HSN	
	MBT-0375	0.375	0.349	•	•	•	Precision ground, harder grade, for semi-finish and finish milling. Excellent choice for unattended finish milling at small depth and high speeds and feed rates.
	MBT-0500	0.500	0.377	•	•	•	
	MBT-0625	0.625	0.443	•	•	•	
	MBT-0750	0.750	0.518	•	•	•	
	MBT-1000	1.000	0.716	•	•	•	
	MBT-1250	1.250	0.865	•	•	•	

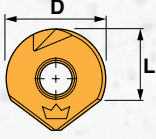
RB-N	Number	D	L	Grade			Description
				XRN	TLN	HSN	
	RB-0375-N	0.375	0.390	•	•	•	Precision ground, non-chipbreaker. Best choice for cavity, core and profile milling of pre-hard and fully hard die/mold steels, cast steels and cast iron. Strongest cutting edge design.
	RB-0500-N	0.500	0.377	•	•	•	
	RB-0625-N	0.625	0.443	•	•	•	
	RB-0750-N	0.750	0.518	•	•	•	
	RB-1000-N	1.000	0.716	•	•	•	
	RB-1250-N	1.250	0.865	•	•	•	

RBT

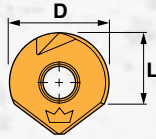
RBT	Number	D	L	Grade			Description
				XRN	TLN	HSN	
	RB-0375-T	0.375	0.349			•	Precision ground for semi-finish and finish milling. Excellent choice for unattended finish milling at small depth and high speed and feed rates.
	RB-0500-T	0.500	0.377			•	
	RB-0625-T	0.625	0.443			•	
	RB-0750-T	0.750	0.518			•	
	RB-1000-T	1.000	0.716			•	
	RB-1250-T	1.250	0.865			•	

NA

Non-coated grade.

XRN

Multi-layer hybrid coating of AlCrN. This coating has very good heat resistance and also a low friction coefficient. The XRN coating is designed for use in HSM of un-heat treated softer materials such as Titanium, Inconel, Stainless Steels and other gummy materials that require the use of liquid coolant.

HSN

Millstar's new coating is a multi-layer hybrid Nano coating. This new coating has very good heat resistance and high hardness. The HSN coating is designed for use in HSM of Heat Treated materials up to 72 HRC.

ALTiN-EXALON (TLN)

Titanium Aluminum Nitride advanced PVD coating. A special, improved ALTiN coating approaching surface hardness of CBN on a tough substrate. Recommended for tough and hard metal machining applications.

DMD

Diamond coating. Custom coating for cutting non-ferrous, non-metallic and very abrasive materials at highly elevated speeds. Use on copper, bronze, brass, aluminum-silicon alloys, carbon graphite, solid and fiber-reinforced plastics, ceramics and composite materials.

Custom tool coatings for specific applications are available by request.

Choosing Cutting Parameters/Calculating Cutting Speed and Feed – INCH For Ball Nose Inserts

Table 1 - Cutting Conditions for Using Steel Shank Holders

Working Material	Hardness	Grade	SFM	Feed fn (inch/Rev)									Ap Max	Ae Max
				Insert Diameter (inch)										
				0.250	0.312	0.375	0.500	0.625	0.750	1.000	1.250			
Low Alloy Steel (1.7225)	200-280HB	TLN, HSN	450-1200	0.008	0.012	0.016	0.016	0.020	0.020	0.020	0.020	.10 x D	.40 x D	
Alloy & Die Steel (1.2311, P20, DME2/3/5)	32-42HRC	TLN, HSN	300-800	0.006	0.010	0.012	0.016	0.016	0.016	0.020	0.020	.8 x D	.35 x D	
Tool Steel (1.2344, 1.2379)	42-52HRC	TLN, HSN	300-700	0.006	0.010	0.012	0.016	0.020	0.020	0.020	0.020	.6 x D	.30 x D	
Stainless Steel (1.4301, 1.4401)	200-350HB	XRN, TLN, HSN	250-400	0.006	0.010	0.012	0.016	0.016	0.016	0.020	0.020	.10 x D	.40 x D	
Gray Cast Iron (GG25-GG30)	160-260HB	TLN, HSN	600-1200	0.008	0.012	0.016	0.020	0.023	0.023	0.028	0.028	.10 x D	.50 x D	
Nodular Cast Iron (GGG60-GGG70)	180-300HB	TLN, HSN	450-1200	0.008	0.012	0.016	0.020	0.023	0.023	0.028	0.028	.15 x D	.50 x D	
Copper Alloy	80-150HB	XRN	450-1500	0.010	0.016	0.020	0.023	0.028	0.028	0.028	0.028	.10 x D	.40 x D	
Aluminum Alloys	30-120HB	XRN	1000-3000	0.010	0.016	0.020	0.023	0.028	0.028	0.028	0.028	.10 x D	.50 x D	
Graphite		TLN, HSN	600-2000	0.012	0.020	0.023	0.028	0.030	0.030	0.030	0.030	.20 x D	.50 x D	
Ni & Co Based Alloy	250-320HB	XRN, HSN	100-300	0.006	0.008	0.012	0.016	0.016	0.020	0.020	0.020	.8 x D	.50 x D	
Titanium Alloy (Annealed)	<350HB	XRN, HSN	150-400	0.006	0.008	0.010	0.012	0.012	0.016	0.020	0.020	.8 x D	.33 x D	
Titanium Alloy (Sol. Treated/Aged)	<380HB	XRN, HSN	120-300	0.004	0.006	0.008	0.012	0.012	0.012	0.016	0.016	.8 x D	.35 x D	

Table 2 - Cutting Conditions for Using Carbide Shank Holders

Working Material	Hardness	Grade	SFM	Feed fn (inch/Rev)									Ap Max	Ae Max
				Insert Diameter (inch)										
				0.250	0.312	0.375	0.500	0.625	0.750	1.000	1.250			
Low Alloy Steel (1.7225)	200-280HB	TLN, HSN	450-1200	0.012	0.016	0.016	0.02	0.023	0.023	0.028	0.028	.10 x D	.50 x D	
Alloy & Die Steel (1.2311, P20, DME2/3/5)	32-42HRC	TLN, HSN	300-1200	0.012	0.012	0.012	0.016	0.02	0.02	0.023	0.023	.8 x D	.40 x D	
Tool Steel (1.2344, 1.2379)	42-52HRC	TLN, HSN	300-800	0.012	0.012	0.012	0.016	0.02	0.02	0.023	0.023	.6 x D	.35 x D	
Stainless Steel (1.4301, 1.4401)	200-350HB	XRN, TLN, HSN	250-400	0.012	0.012	0.016	0.02	0.023	0.028	0.028	0.03	.10 x D	.50 x D	
Gray Cast Iron (GG25-GG30)	160-260HB	TLN, HSN	600-1200	0.012	0.016	0.02	0.02	0.023	0.028	0.8	0.04	.10 x D	.40 x D	
Nodular Cast Iron (GGG60-GGG70)	180-300HB	TLN, HSN	450-1200	0.012	0.016	0.016	0.02	0.023	0.023	0.028	0.03	.10 x D	.40 x D	
Copper Alloy	80-150HB	XRN	450-1500	0.012	0.016	0.016	0.02	0.023	0.023	0.028	0.028	.10 x D	.40 x D	
Aluminum Alloys	30-120HB	XRN	1000-3000	0.012	0.016	0.02	0.023	0.028	0.028	0.03	0.03	.10 x D	.40 x D	
Graphite		TLN, HSN	600-2000	0.012	0.02	0.023	0.028	0.03	0.03	0.03	0.03	.20 x D	.40 x D	
Ni & Co Based Alloy	250-320HB	XRN, HSN	100-300	0.012	0.012	0.016	0.016	0.02	0.023	0.023	0.028	.8 x D	.50 x D	
Titanium Alloy (Annealed)	<350HB	XRN, HSN	150-400	0.006	0.008	0.012	0.012	0.012	0.016	0.02	0.02	.8 x D	.50 x D	
Titanium Alloy (Sol. Treated/Aged)	<380HB	XRN, HSN	120-300	0.004	0.006	0.008	0.012	0.012	0.016	0.016	0.02	.8 x D	.50 x D	
Harden Steel (1.2344, 1.2379)	45-55HRC	TLN, HSN	300-1200	0.008	0.01	0.012	0.016	0.02	0.02	0.023	0.023	.8 x D	.35 x D	

Choosing Cutting Parameters/Calculating Cutting Speed and Feed – INCH

1. Find the Cutting Speed & Feed f_n

Find SFM and f_n range in Table 1 or Table 2 at left. Choose the average value for SFM and the lower value for feed in the range.

2. Compute the D_w

In order to compute the RPM value of the spindle it is necessary to determine the D_w which is the effective engaged tool diameter. The D_w depends on the geometry of the inserts (ball nose or toroid) and the relative position of the tool against the working piece surface. Example calculation is of D_w is presented to the right.

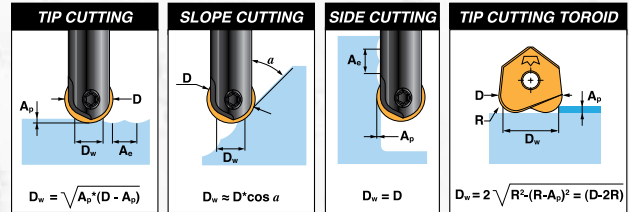

3. Calculate Spindle Speed

Use the formula: $N = \text{SFM} \times 3.82 (\div D_w)$

Table 3 - Working Diameter For Ball Nose Tools

ØD	0.250	0.312	0.375	0.500	0.625	0.750	1.000	1.250
Depth of cut	Dw Working Diameter (inch) Actual effective cutting diameter							
0.020	0.135	0.153	0.169	0.196	0.220	0.242	0.280	0.314
0.050	0.200	0.229	0.255	0.300	0.339	0.374	0.436	0.490
0.075	0.229	0.267	0.300	0.357	0.406	0.450	0.527	0.594
0.100	0.245	0.292	0.332	0.400	0.458	0.510	0.600	0.678
0.125	0.250	0.306	0.345	0.433	0.500	0.559	0.661	0.750
0.156		0.312	0.370	0.464	0.541	0.609	0.726	0.827
0.188			0.375	0.484	0.573	0.650	0.781	0.893
0.250				0.500	0.612	0.707	0.866	1.000
0.312					0.625	0.739	0.927	1.082
0.375						0.750	0.968	1.146
0.500							1.000	1.225
0.625								1.250

Table 4 - Working Diameter For Toroid Tools

Insert Diameter "D"	0.375	0.500	0.625	0.750	1.000	1.250
Depth of cut	Dw Working Diameter (inch) Actual cutting diameter of toroid inserts					
0.020	0.260	0.385	0.465	0.544	0.696	0.845
0.050	0.325	0.450	0.541	0.630	0.800	0.964
0.075	0.354	0.479	0.579	0.675	0.867	1.031
0.100	0.370	0.495	0.604	0.707	0.900	1.083
0.125	0.375	0.500	0.618	0.720	0.933	1.125
0.156			0.625	0.745	0.964	1.166
0.188				0.750	0.984	1.198
0.250					1.000	1.237
0.312						1.250

4. Calculate the Table Feed V_f (m/min)

Use the formula: $V_f = N * f_n * K_f$. K_f is the feed rate multiplier coefficient taking into consideration that chip load is less than theoretical value. Take the value of K_f from Table 5 or Table 6.

Table 5 - Feed Rate Multiplier For Ball Nose Inserts

Insert Diameter "D"	0.250	0.312	0.375	0.500	0.625	0.750	1.000	1.250
Depth of cut	Feedrate Multiplier Factors (for Working Diameters D_w)							
0.020	1.850	2.040	2.220	2.550	2.840	3.000	3.750	4.000
0.050	1.250	1.360	1.470	1.670	1.840	2.000	2.290	2.550
0.075	1.090	1.170	1.250	1.400	1.540	1.670	1.900	2.100
0.100	1.020	1.070	1.130	1.250	1.370	1.470	1.670	1.840
0.125	1.000	1.020	1.060	1.150	1.250	1.340	1.510	1.660
0.156		1.000	1.010	1.080	1.160	1.230	1.380	1.510
0.188			1.000	1.030	1.090	1.150	1.280	1.400
0.250				1.000	1.020	1.060	1.150	1.250
0.312					1.000	1.020	1.080	1.150
0.375						1.000	1.030	1.090
0.500							1.000	1.020
0.625								1.000

Table 6 - Feed Rate Multiplier For Toroid Tools

Insert Diameter "D"	0.375	0.500	0.625	0.750	1.000	1.250
Depth of cut	FEEDRATE MULTIPLIER FACTORS (inch) (for Toroid Working Diameters D_w)					
0.020	1.850	1.850	2.040	2.220	2.550	2.840
0.050	1.250	1.250	1.360	1.470	1.670	1.840
0.075	1.090	1.090	1.170	1.250	1.400	1.540
0.100	1.020	1.020	1.070	1.130	1.250	1.370
0.125	1.000	1.000	1.020	1.060	1.150	1.250
0.156			1.000	1.010	1.080	1.160
0.188				1.000	1.030	1.090
0.250					1.000	1.020
0.312						1.000

Verify Surface Roughness (R_{th})

1. Decreasing the A_e and feed by half will improve surface roughness by 4 times.
2. Using $f_z = A_e$ in most cases is the best option.

Surface Roughness Step-Over

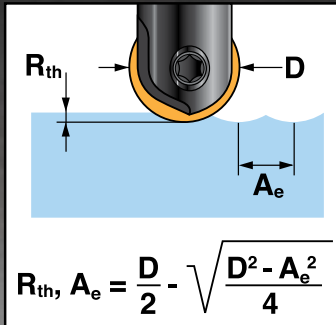

Surface Roughness Feed Dir

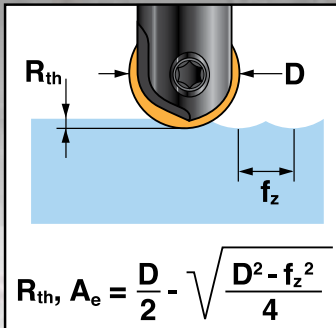

$f_z > A_e$

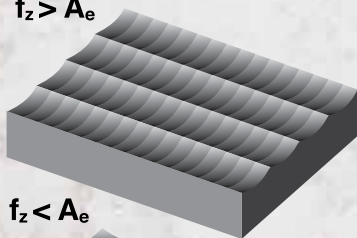

$f_z < A_e$

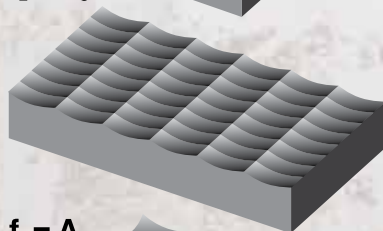

$f_z = A_e$

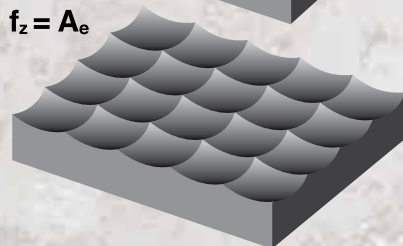

Feed & Speed Calculations

Nomenclature

D = cutter/insert diameter	fz = feed per tooth	ae = width of cut, step-over	R _{th,ae} = theoretical surface roughness in step-over direction
Dw = effective cutter diameter	Fz _{cor} = feed/tooth, chip thinning corrected	R = insert radius	R _{th,fz} = theoretical surface roughness in feed direction
z = number of teeth	CF = centerline feed, helical interpolation	SFM = surface feet per minute	B = bore dia., helical interpolation
Vc = cutting speed	x = multiplier symbol (inch)	RPM = revolutions per minute	IC = inscribed circle (2 x R)
n = number of revolutions per minute	• = multiplier symbol (metric)	IPM = inch per minute, feed rate	Q = metal removal rate
Vf = feed rate, or table feed	ap = axial depth of cut	π = 3.14159...circle, circumference:dia. ratio	
f = feed per revolution			

Cutting Speed

To find the SFM of a cutter:

$$SFM = \frac{\pi \times D \times RPM}{12} = 0.262 \times D \times RPM$$

Example:

To find the SFM of a 3/4" Ø cutter rotating at 6000 RPM:

$$0.262 \times D \times RPM = 0.262 \times 0.75 \times 6000 = 1179 \text{ SFM}$$

Metric Formula:

$$v_c = \frac{n \cdot \pi \cdot Dw}{1000} = \text{m / minute}$$

Feed Per Tooth

To find the feed per tooth of a cutter:

$$FZ = \frac{IPM}{z \times RPM}$$

Example

To find the feed per tooth of a two flute cutter rotating at 10000 RPM with a table travel of 240 inches per minute:

$$FZ = \frac{240}{2 \times 10\,000} = 0.012 \text{ FZ}$$

Metric Formula:

$$f = \frac{v_f}{n \cdot z} = \text{mm / tooth}$$

Effective Cutting Diameter, Ball Nose

To find the effective cutter Ø of a ball nose tool:

$$Dw = 2 \times \sqrt{R^2 - (R - a_p)^2}$$

Example

To find the effective cutter diameter engaged of a 1.0" Ø ball nose tool cutting at 0.040" depth of cut:

$$Dw = 2 \times \sqrt{0.5^2 - (0.5 - 0.040)^2} = 0.392"$$

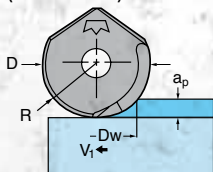

Metric Formula:

use same formula in mm.

Surface Roughness, Step-Over

To find the surface roughness in step-over direction:

$$R_{th,ae} = \frac{D}{2} - \sqrt{\frac{D^2 - a_e^2}{4}}$$

Example

To find the theoretical roughness of a 3/4" Ø ball nose tool in step-over direction of the cut (peak-to-valley or cusp height), with a 0.030 step-over value:

$$R_{th,ae} = \frac{.75}{2} - \sqrt{\frac{.75^2 - .03^2}{4}} = 0.0003"$$

Metric Formula: use same formula in mm.

Spindle Speed

To find the RPM of a cutter:

$$RPM = \frac{12 \times SFM}{\pi \times D} = \frac{3.82 \times SFM}{D}$$

Example

To find the RPM of a 1/2" Ø cutter rotating at 800 SFM:

$$RPM = \frac{3.82 \times 800}{.500} = 6112 \text{ RPM}$$

Metric Formula:

$$n = \frac{v_c \cdot 1000}{\pi \cdot Dw} = \text{min}^{-1}$$

Feed Rate or Table Feed

To find the feed (table feed) in inches per minute:

$$IPM = RPM \times f_z \times z$$

Example

To find the feed per tooth of a two flute cutter rotating at 5000 RPM with a feed per tooth of 0.006:

$$IPM = 5000 \times 0.006 \times 2 = 60 \text{ IPM}$$

Metric Formula:

$$v_f = n \cdot f_z \cdot z = \text{mm / minute}$$

Effective Cutting Diameter, Toroid

To find the effective cutter Ø of a Toroid bull nose tool:

$$Dw = 2 \times \sqrt{R^2 - (R - a_p)^2} + (D - 2R)$$

Example

To find the effective cutter diameter engaged of a 3/4" Ø Toroid bull nose tool cutting at 0.100" depth of cut:

$$Dw = 2 \times \sqrt{.1875^2 - (.1875 - .1)^2} + (.75 - (2 \times .1875)) = .707$$

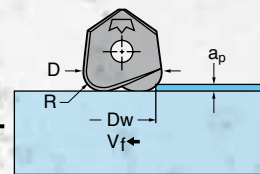

Metric Formula: use same formula in mm.

Surface Roughness, Feed Direction

To find the surface roughness in feed direction:

$$R_{th,fz} = \frac{D}{2} - \sqrt{\frac{D^2 - f_z^2}{4}}$$

Example

To find the theoretical roughness of a 3/4" Ø ball nose tool in feed direction of the cut (peak-to-valley or cusp height), with a 0.005 feed per tooth value:

$$R_{th,fz} = \frac{.75}{2} - \sqrt{\frac{.75^2 - .005^2}{4}} = 0.000008"$$

Metric Formula: use same formula in mm.

Copy Milling Program Tools

Millstar face mills are equally useful on newer high velocity machines and older slower equipment and will optimize milling performance of all your machine tools. The hardened tool bodies can be run at aggressive spindle speed and feed rates, when used with Millstar's precision ground, strong and thick, round inserts with proven hard, high performance TLN and HSN tool coatings.

The tools provide for precision finish results, minimal tool deflection and run-out. Excellent milling results can be achieved in roughing, semi finishing and fine finishing in Z-level, profiling or raster cuts, as well as in linear or circular interpolation milling or ramping.

The tools may be used with coolant, but we recommend dry, mist or MQL (minimum quantity lubrication) milling with strong air blast when high speed or hard machining steel, particularly in the higher hardness range (> 45HRc / 425 HBN).



<i>Copy Milling Program Tool Contents</i>			
FM Style 1	Toroid Cylindrical End Milling Cutter	26	
FM Style 2	Toroid Taper End Milling Cutter	26	
FMA	Arbor Style Milling Cutter	26	
Insert Data		27	
Cutting Conditions		27	
APKT Series		28	
Arbor Style Holders		29	
Screw On Heads		29	

<i>Milling Cutters Identification System</i>								
<i>Arbor</i>								
Measurement System	Denotes Copy Milling Arbor Style	Denotes Diameter Size		Denotes Number of Flutes				
Imperial	FMA	2000	/	5				
Metric	FMA	63	/	5				
<i>Shank</i>								
Measurement System	Denotes Copy Milling Cutter	Denotes Diameter Size		Denotes Number of Flutes		Denotes Tool Cutter Length		Denotes Tool Diameter Shank
Imperial	FM	1000	/	2	-	6.0	-	1000
Metric	FM	25	/	2	-	180	-	25

Copy Milling Program Tools

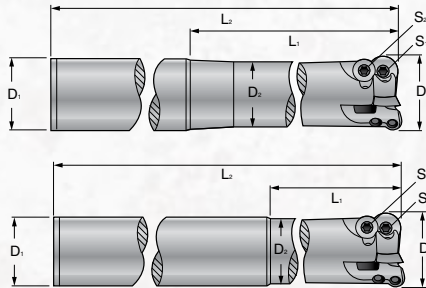

Toroid Taper End Milling Cutters

Toroid Cylindrical End Milling Cutters

Tool Ordering Number	Dimensions						Insert Screw	Face Clamp Screw	Key	Insert Code
	ØD	ØD1	ØD2	L1	L2	Z				
FM-1000/2-6.0-1000	1.000	1.000	0.882	1.250	6.000	2	FMIS-1	FMIS-2	T15	FMI-12T3 FMIR-12T3
FM-1250/3-6.0-1000	1.250	1.000	0.882	1.500	6.000	3	FMIS-1	FMIS-2	T15	FMI-12T3 FMIR-12T3
FM-1500/4-6.0-1250	1.500	1.250	1.125	1.500	6.000	4	FMIS-1	FMIS-2	T15	FMI-12T3 FMIR-12T3
FM-1500/4-9.0-1250	1.500	1.250	1.125	1.500	6.000	4	FMIS-1	FMIS-2	T15	FMI-12T3 FMIR-12T3

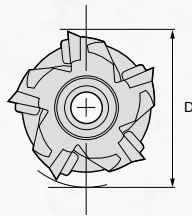
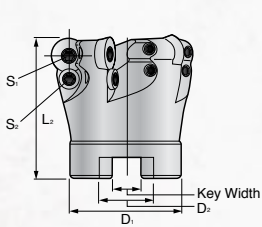

Arbor Style Milling Cutters

Tool Ordering Number	Dimensions						Arbor Screw	Insert Screw S1	Face Clamp Screw S2	Key	Insert Code
	ØD	ØD1	L2	Z	Key Width	D2					
FMA-2000/5	2.000	1.570	2.000	5	0.312	0.750	0.375	FMIS-1	FMIS-2	T15	FMI-12T3 FMIR-12T3
FMA-2500/5	2.500	1.570	2.000	5	0.375	1.000	0.500	FMIS-1	FMIS-2	T15	FMI-12T3 FMIR-12T3
FMA-3000/5	3.000	1.570	2.000	5	0.375	1.000	0.500	FMIS-1	FMIS-2	T15	FMI-12T3 FMIR-12T3
FMA-4000/7-16	4.000	2.880	2.500	7	0.500	1.250	0.625	FMIS-6	FMIS-6 FMIW-6	T20	FMI-1604
FMA-6000/9-16	6.000	3.820	2.500	9	0.625	1.500	-	FMIS-6	FMIS-6 FMIW-6	T20	FMI-1604

Copy Milling Program Tools

Working Diameter (D_w)

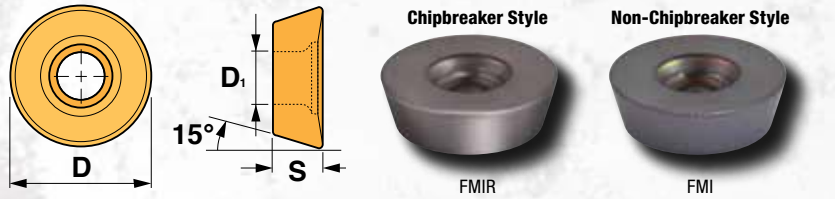

Insert Data

Tool Ordering Number	Dimensions			HSN	TLN
	D	S	D1		
FMI-0702	0.275/7mm	0.094	0.112	•	•
FMI-1003	0.393/10mm	0.125	0.153	•	•
FMI-12T3	0.472/12mm	0.156	0.154	•	•
FMIR-12T3	0.472/12mm	0.156	0.154	•	•
FMI-1604	0.629/16mm	0.205	0.1875	•	•

Cutting Conditions: Recommended Cutting Speed And A_p

Working Material	Hardness	Insert Type	Grade	SFM	A_p Max Roughing	A_p Max Medium	A_p Max Light
Low Alloy Steel (1.7225)	200-280HB	FMI	HSN, TLN	300-800	.08-.16	.04-.08	.004-.04
Alloy & Die Steel (1.2311, P20, DME2/3/5)	32-42HRC	FMI	HSN, TLN	300-600	.08-.16	.04-.08	.004-.04
Tool Steel (1.2344, 1.2379)	42-52HRC	FMI	HSN, TLN	200-450	.08-.12	.04-.08	.004-.04
Stainless Steel (1.4301, 1.4401)	200-350HB	FMIR	HSN, TLN	300-600	.08-.16	.04-.08	.004-.04
Gray Cast Iron (GG25-GG30)	160-260HB	FMIR	HSN, TLN	300-600	.08-.16	.04-.08	.004-.04
Nodular Cast Iron (GGG60-GGG70)	180-300HB	FMIR	HSN, TLN	300-1200	.08-.16	.04-.08	.004-.04
Copper Alloy	80-150HB	FMIR	TLN	1200	.08-.16	.04-.08	.004-.04
Aluminum Alloys	30-120HB	FMIR	TLN	3000	.08-.16	.04-.08	.004-.04
Ni & Co Based Alloy	250-320HB	FMIR	HSN, TLN	100-450	.08-.12	.04-.08	.004-.04
Titanium Alloy (Annealed)	<350HB	FMIR	HSN, TLN	100-450	.08-.12	.04-.08	.004-.04

Cutting Conditions: Recommended Feed f_z (in./tooth)

Operation	A_p										
	IC	0.012	0.02	0.028	0.031	0.04	0.05	0.08	0.12	0.16	0.2
Light	10	0.012	0.008	0.008	0.007	0.006	0	0	0	0	0
	12	0.015	0.012	0.010	0.012	0.008	0.006	0	0	0	0
	16	0.016	0.015	0.012	0.012	0.009	0.008	0.007	0	0	0
Rough	10	0	0	0	0	0.012	0.009	0.008	0.007	0.006	0.005
	12	0	0	0	0	0.016	0.014	0.012	0.011	0.009	0.008
	16	0	0	0	0	0.020	0.017	0.015	0.012	0.011	0.010

The "fz" indicated above is for an overhang of 3xD. The values are calculated based on the recommended thickness of the chip "hm".

LIGHT: A_e up to 25% of the Diameter of the Tool "D".

ROUGH: A_e up to 75% of the Diameter of the Tool "D".

In order to compute the RPM value of the spindle it is necessary to determine the D_w which is the effective engaged tool diameter. The D_w depends on the geometry of the inserts (ball nose or toroid) and of the relative position of the tool against the working piece surface. A formula is presented.

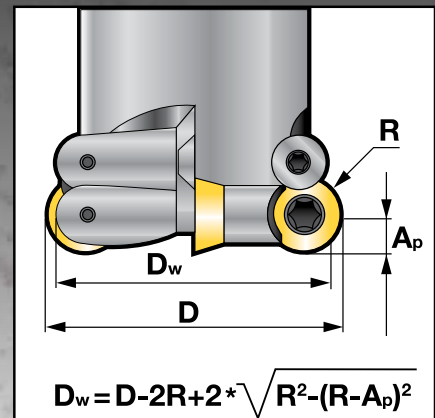

APKT Series, Inserts and Bodies

Inserts

Millstar Insert Number	Corner Radius	Use
APHT-1003-AL	0.031	Aluminum
APHT-1604-AL	0.031	Aluminum
APKT-1003-TLN or HSN	0.016	Steel
APKT-1003-TCT	0.016	Steel
APKT-1604-TCT	0.031	Steel
APKT-1604-TLN or HSN	0.031	Steel
APMT-1604-12-TLN	0.047	Steel
APMT-1604-16-TLN	0.063	Steel
APMT-1604-24-TLN	0.094	Steel
APMT-1604-32-TLN	0.125	Steel
APMT-1604-40-TLN	0.157	Steel
APMT-1604-48-TLN	0.189	Steel
APMT-1604-64-TLN	0.252	Steel

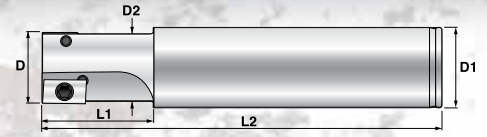
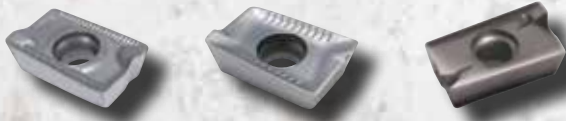

DSKI Bodies for 1003 Insert

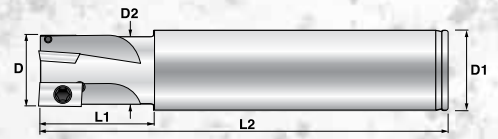

DSMI Bodies for 1604 Insert

Bodies for 1003 Insert

Millstar Part Number	Diameter (D)	Shank Diameter (D1)	Overall Length (L2)	Effective Length (L1)	No. of Flutes	Insert size	Screw	Torx
DSKI-0375-3.0-0500	0.375	0.500	3.000	0.800	1	1003	1425	T107
DSKI-0375-6.0-0500	0.375	0.500	6.000	0.800	1	1003	1425	T107
DSKI-0500-3.25-0625	0.500	0.625	3.250	1.000	1	1003	1425	T107
DSKI-0500-6.0-0625	0.500	0.625	6.000	1.000	1	1003	1425	T107
DSKI-0625-3.25-0625	0.625	0.625	3.250	1.000	2	1003	1425	T107
DSKI-0625-6.0-0625	0.625	0.625	6.000	1.000	2	1003	1425	T107
DSKI-0750-3.5-0750	0.750	0.750	3.500	1.250	3	1003	1425	T107
DSKI-0750-8.0-0750	0.750	0.750	8.000	1.250	3	1003	1425	T107
DSKI-1000-3.5-1000	1.000	1.000	3.500	1.250	4	1003	1225	T107
DSKI-1000-8.0-1000	1.000	1.000	8.000	1.250	4	1003	1225	T107
DSKI-1250-3.75-1000	1.250	1.000	3.750	1.250	5	1003	1225	T107
DSKI-1250-10.0-1000	1.250	1.000	10.000	1.250	5	1003	1225	T107
DSKI-1500-4.0-1250	1.500	1.250	4.000	1.250	6	1003	1225	T107
DSKI-1500-10.0-1250	1.500	1.250	10.000	1.250	6	1003	1225	T107

Bodies for 1604 Insert

Millstar Part Number	Diameter (D)	Shank Diameter (D1)	Overall Length (L2)	Effective Length (L1)	No. of Flutes	Insert size	Screw	Torx
DSMI-0750-3.5-0750	0.750	0.750	3.500	1.250	1	1604	1440	T15
DSMI-0750-8.0-0750	0.750	0.750	8.000	1.250	1	1604	1440	T15
DSMI-1000-3.5-1000	1.000	1.000	3.500	1.250	2	1604	1440	T15
DSMI-1000-8.0-1000	1.000	1.000	8.000	1.250	2	1604	1440	T15
DSMI-1250-3.75-1000	1.250	1.000	3.750	1.250	3	1604	1240	T15
DSMI-1250-10.0-1000	1.250	1.000	10.000	1.250	3	1604	1240	T15
DSMI-1500-4.0-1250	1.500	1.250	4.000	1.250	4	1604	1240	T15
DSMI-1500-10.0-1250	1.500	1.250	10.000	1.250	4	1604	1240	T15

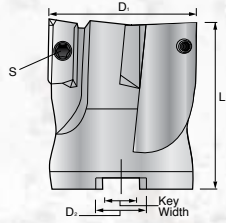

Arbor Style Holders for 1003 Insert

Millstar Part Number	Diameter (D1)	Height (L1)	Keyway	Bore (D2)	No. of Flutes	Insert size	Screw (S)	Torx
DSSA-1500/6	1.500	1.750	0.250	0.500	6	1003	1225	T07
DSSA-2000/7	2.000	1.750	0.312	0.750	7	1003	1225	T07
DSSA-2500/9	2.500	2.000	0.375	1.000	9	1003	1225	T07

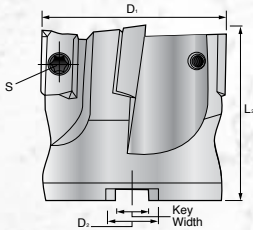

Arbor Style Holders for 1604 Insert

Millstar Part Number	Diameter (D1)	Height (L1)	Keyway	Bore (D2)	No. of Flutes	Insert size	Screw (S)	Torx
DSMA-1500/4	1.500	1.750	0.250	0.500	4	1604	1240	T15
DSMA-2000/5	2.000	1.750	0.312	0.750	5	1604	1240	T15
DSMA-2500/6	2.500	2.000	0.375	1.000	6	1604	1240	T15
DSMA-3000/7	3.000	2.000	0.375	1.000	7	1604	1240	T15
DSMA-4000/8	4.000	2.000	0.500	1.250	8	1604	1240	T15
DSMA-5000/8	5.000	2.000	0.625	1.500	8	1604	1240	T15
DSMA-6000/9	6.000	2.000	0.625	1.500	9	1604	1240	T15

Screw On Heads for 1003 Insert

Millstar Part Number	Diameter	Length	Thread	Pilot Diameter	No. of Flutes	Insert size	Screw	Torx
DSSC-0625/2	0.625	0.905	M8	0.335	2	1003	1425	T07
DSSC-0750/2	0.750	1.181	M10	0.413	2	1003	1425	T07
DSSC-1000/3	1.000	1.378	M12	0.492	3	1003	1425	T07

Screw On Heads for 1604 Insert

Millstar Part Number	Diameter	Length	Thread	Pilot Diameter	No. of Flutes	Insert size	Screw	Torx
DSMC-1000/2	1.000	1.378	M12	0.492	2	1604	1440	T15
DSMC-1250/3	1.250	1.693	M16	0.669	3	1604	1240	T15

Indexable Milling Program Tools for Aluminum Alloys

Indexable Milling Program Tools for Aluminum Alloys Contents

ASMC	Shell Milling Cutters With Side Clearance	31	
ASMN	Shell Milling Cutter With No Side Clearance	31	
AEMC	End Milling Cutter With Side Clearance	31	
AEMN	End Milling Cutter With No Side Clearance	31	

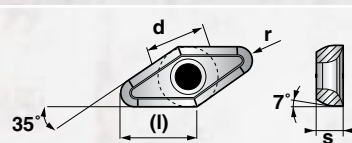

Insert Data

Tool Ordering Number	Dimensions				
	l	s	d	r	Screw
VCGT-110308	11	3.18	2.8	0.8	AIS-1
VCGT-160412	16.6	4.76	4.4	1.2	AIS-2
VCGT-220530	22	5.56	5.5	3	AIS-3

Shank

Measurement System	Denotes Cutter for Non-Ferrous Metals & Plastics	EMC = End Milling Shank Cutter	Denotes Diameter Size		Denotes Tool Cutter Length		Denotes Tool Diameter Shank	Clearance
Inch	A	EMC	42	-	220	-	25	93°
Shank	A	EMN	42	-	220	-	25	90°

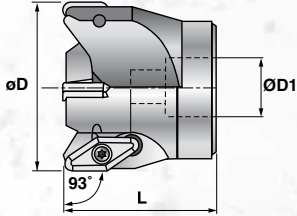

ASMC Shell Milling Cutters

Tool Ordering Number	Dimensions					Use with			RPM Max
	ØD	L	ØD1	Key Width	Z	Screw	Key	Inserts	
ASMC-2.00/3	2.00	2.125	0.75	0.312	3	AIS-2	T15	VCGT-160412	20000

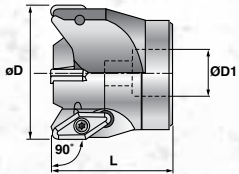

ASMN Shell Milling Cutters

Tool Ordering Number	Dimensions					Use with			RPM Max
	ØD	L	ØD1	Key Width	Z	Screw	Key	Inserts	
ASMN-2.00/3	2.00	2.125	0.75	0.312	3	AIS-2	T15	VCGT-160412	20000

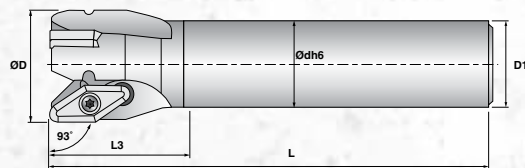

AEMC End Milling Cutters

Tool Ordering Number	Dimensions						Use with			RPM Max
	ØD	L	L1	D1	L3	Z	Screw	Key	Inserts	
AEMC-1.00/3-4	1.00	4.00	0.394	0.75	NA	3	AIS-1	T7	VCGT-110308	30000
AEMC-1.00/3-6	1.00	6.00	0.394	0.75	NA	3	AIS-1	T7	VCGT-110308	30000

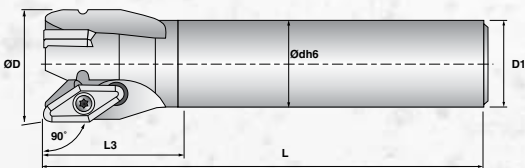

AEMN End Milling Cutters

Tool Ordering Number	Dimensions						Use with			RPM Max
	ØD	L	L1	D1	L3	Z	Screw	Key	Inserts	
AEMN-1.00/3-4	1.00	4.00	0.394	0.75	NA	3	AIS-1	T7	VCGT-110308	30000
AEMN-1.00/3-6	1.00	6.00	0.394	0.75	NA	3	AIS-1	T7	VCGT-110308	30000
AEMN-1.00/3-8	1.00	8.00	0.394	0.75	NA	3	AIS-1	T7	VCGT-110308	30000

High Feed Indexable Milling Program Tools

With new five- and six-axis CNC grinding technology, Millstar has been able to create some of the most sophisticated and complex geometries in use today. With this increase in grinding technology, high-feed tooling has been reborn. The definition of high-feed geometry is producing a positive cutting edge out of a series of continuous radii with no tangent point to induce wear. The geometry must allow the chip to flow up and out of the cut quickly and smoothly. This cutting motion allows the use of heavy chip loads to achieve very high feed rates.



<i>High Feed Indexable Milling Program Tool Contents</i>			
HFSC	Modular Screw-on Heads	34	
HFA	Shell Milling Cutters	34	
HFSS	End Milling Cutters	34	
Insert Data		35	
Cutting Conditions Data		36-38	

<i>Milling Cutters Identification System</i>						
<i>Modular</i>						
Measurement System	Denotes High Feed Cutter	SC = Screw-on Cutter A = Shell Cutter	Denotes Diameter Size		Denotes Number of Flutes	
Imperial	HF	SC	1000	/	3	
Metric	HF	SC	25	/	3	
<i>Shank</i>						
Measurement System	Denotes High Feed Cutter	Denotes Shank Cutter	Denotes Diameter Size		Denotes Tool Cutter Length	Denotes Tool Diameter Shank
Imperial	HF	SS	1000	-	5.5	- 1000
Metric	HF	SS	25	-	140	- 25

High Feed Indexable Milling Program Tools

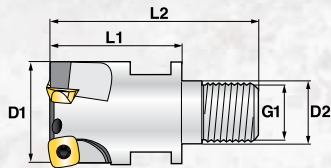

HFSC - Modular Screw-On Heads

Tool Ordering Number	Dimensions					Thread G1	Screw	Clamp	Key	Use with Inserts	CAM R
	ØD	L1	L2	D2	Z						
HFSC-1000/3	1.000	1.250	2.000	.429	3	M10	HFIS-1	-	T8	HFIC-09T3	0.089
HFSC-1250/4	1.250	1.570	2.500	.649	4	M12	HFIS-1	-	T8	HFIC-09T3	0.089
HFSC-1500/4	1.500	1.570	2.500	.649	4	M16	HFIS-2	HFIC-1	T15	HFIC-1204 HFICR-1204	0.138

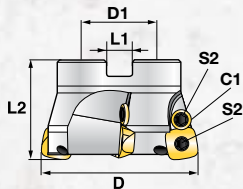

HFA - Shell Milling Cutters

Tool Ordering Number	Dimensions					Screw S1	Screw S2	Clamp C1	Key	Use with Inserts	CAM R
	ØD	ØD1	L1	L2	Z						
HFA-1500/4	1.500	0.500	0.252	1.575	4	HFIS-2	HFIS-2	HFIC-1	T15	HFIC-1204 HFICR-1204	0.138
HFA-2000/5	2.000	0.750	0.312	1.575	5	HFIS-2	HFIS-2	HFIC-1	T15	HFIC-1204 HFICR-1204	0.138
HFA-2500/6	2.500	1.000	0.375	1.575	6	HFIS-2	HFIS-2	HFIC-1	T15	HFIC-1204 HFICR-1204	0.138
HFA-3000/7	3.000	1.000	0.375	1.968	7	HFIS-2	HFIS-2	HFIC-1	T15	HFIC-1204 HFICR-1204	0.138
HFA-4000/8	4.000	1.250	0.500	1.968	8	HFIS-2	HFIS-2	HFIC-1	T15	HFIC-1204 HFICR-1204	0.138

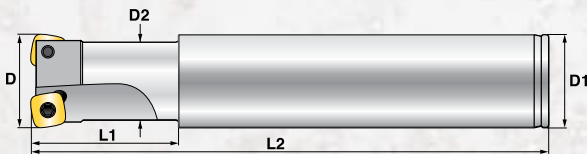

HFSS - End Milling Cutters

Tool Ordering Number	Dimensions					Screw	Clamp C1	Key	Use with Inserts	CAM R
	ØD	ØD1	L1	L2	Z					
HFSS-1000-5.5-1000	1.000	1.000	1.580	5.500	3	HFIS-1	-	T8	HFIC-09T3	0.089
HFSS-1000-7.0-1000	1.000	1.000	1.580	7.000	3	HFIS-1	-	T8	HFIC-09T3	0.089
HFSS-1250-6.0-1250	1.250	1.250	1.580	6.000	3	HFIS-1	-	T8	HFIC-09T3	0.089
HFSS-1250-8.0-1250	1.250	1.250	1.580	8.000	3	HFIS-1	-	T8	HFIC-09T3	0.089
HFSS-1500-6.0-1500	1.500	1.500	1.580	6.000	4	HFIS-2	HFIC-1	T15	HFIC-1204 HFICR-1204	0.138
HFSS-1500-9.0-1500	1.500	1.500	1.580	9.000	4	HFIS-2	HFIC-1	T15	HFIC-1204 HFICR-1204	0.138

High Feed Indexable Milling Program Tools

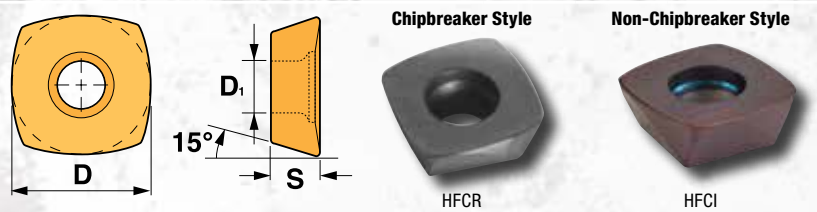

Insert Data

Tool Ordering Number	Dimensions			Grade		CAM
	D	S	D1	XRN	HSN	R
HFCI-09T3	.375	.156	.133	•	•	0.089
HFCI-1204	.500	.187	.173	•	•	0.138
HFCR-09T3	.375	.156	.133	•	•	0.089
HFCR-1204	.500	.187	.173	•	•	0.138

Machining Application Data

Tool Ordering Number	Dimensions				Helical Interpolation	
	ØD	ØDh	Ap	F	ØDh min	ØDh max
HFSC-1000/3	1.000	9mm	0.040	0.500	1.400	1.900
HFSC-1250/4	1.250	9mm	0.040	0.750	1.800	2.250
HFSC-1500/4	1.500	12mm	0.040	0.800	2.000	2.500
HFSS-1000-5.5-1000	1.000	9mm	0.040	0.500	1.500	1.900
HFSS-1000-7.0-1000	1.000	9mm	0.040	0.500	1.500	1.900
HFSS-1250-6.0-1250	1.250	9mm	0.040	0.800	1.000	2.500
HFSS-1250-8.0-1250	1.250	9mm	0.040	0.800	1.000	2.500
HFSS-1500-6.0-1500	1.500	12mm	0.040	1.125	1.250	3.000
HFSS-1500-9.0-1500	1.500	12mm	0.066	0.800	1.250	3.000
HFA-1500/4	1.500	12mm	0.066	1.000	2.500	3.250
HFA-2000/5	2.000	12mm	0.066	1.250	3.125	3.750
HFA-2500/6	2.500	12mm	0.066	1.900	4.000	4.750
HFA-3000/7	3.000	12mm	0.066	2.500	5.500	6.000
HFA-4000/8	4.000	12mm	0.066	3.250	7.000	7.750

- For Slant Milling or Helical Interpolation decrease the recommended feed by 30%.
- In case of Helical Interpolation do not exceed the max Ap/revolution.
- For Plunging use 50% of recommended feed only.
- For insert HFCI 09T3 the max Ae is: 0.200
- For insert HFCI 1204 the max Ae is: 0.250

The values of “n” and “Vf” in the tables on the following pages are computed. In the application, use the closest (up side) speed from the range of the machine tool.

The cutting parameters have to be adjusted accordingly to the rigidity of the machine-tool and working piece.

In case of hard steel alloy of 50-55 HRC decrease by 30% the Ap, Vc and feed.

Helical Interpolation

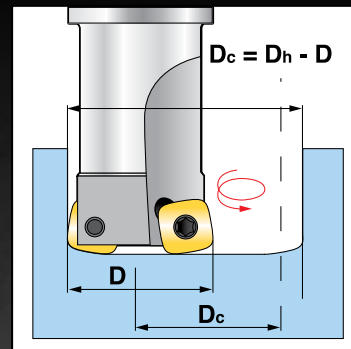

Slant Milling

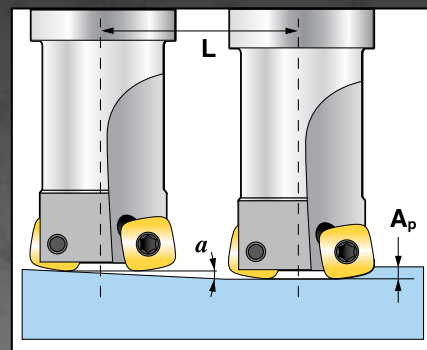

Plunge Milling

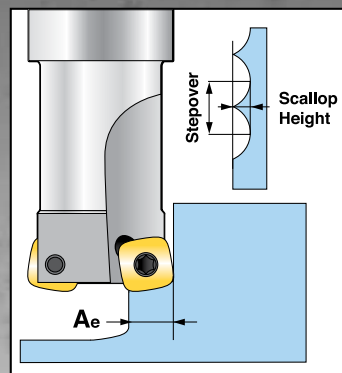

Facing - Max Flat

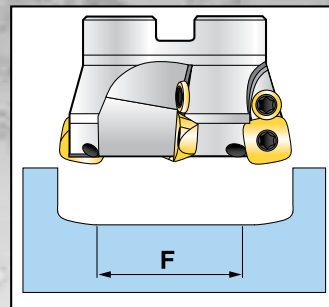

High Feed Indexable Milling Program Tools

Cutting Conditions Data

Cutter	Insert	Grade	Work Piece Material	Overhang	n	Vc	Vf	fz	Ap	Ae
					RPM	sfm	Max RPM	inch/tooth	inch	inch
HFSC-1000/3	HFCl-09T3	HSN-XRN	Alloy Steel <32HRC	<3D	2420	623	11618	0.040	0.025	<.75
				3D-5D	1783	459	5350	0.040	0.025	<.75
				5D-7D	1656	426	4968	0.040	0.025	<.75
				>7D	1146	295	3439	0.040	0.025	<.75
			Alloy Steel 32-42HRC	<3D	2038	524	9783	0.040	0.025	<.75
				3D-5D	1656	426	4968	0.040	0.025	<.75
				5D-7D	1529	393	4586	0.040	0.025	<.75
				>7D	1146	295	3439	0.040	0.025	<.75
			Tool Steel 42-52HRC	<3D	1783	459	7490	0.040	0.025	<.75
				3D-5D	1274	328	3057	0.040	0.025	<.75
				5D-7D	1274	328	3057	0.040	0.025	<.75
				>7D	1146	295	2064	0.040	0.025	<.75
			Cast Iron	<3D	2293	590	11006	0.040	0.025	<.75
				3D-5D	1783	459	6420	0.040	0.025	<.75
				5D-7D	1656	426	5962	0.040	0.025	<.75
				>7D	1146	295	4127	0.040	0.025	<.75
HFSC-1250/4	HFCl-09T3	HSN-XRN	Alloy Steel <32HRC	<3D	2017	623	12102	0.040	0.025	<.75
				3D-5D	1486	459	5350	0.040	0.025	<.75
				5D-7D	1380	426	4968	0.040	0.025	<.75
				>7D	955	295	3439	0.040	0.025	<.75
			Alloy Steel 32-42HRC	<3D	1699	525	10191	0.040	0.025	<.75
				3D-5D	1380	427	4968	0.040	0.025	<.75
				5D-7D	1274	394	4586	0.040	0.025	<.75
				>7D	955	295	3439	0.040	0.025	<.75
			Tool Steel 42-52HRC	<3D	1486	459	7134	0.040	0.025	<.75
				3D-5D	1062	328	3397	0.040	0.025	<.75
				5D-7D	1062	328	2548	0.040	0.025	<.75
				>7D	955	295	2293	0.040	0.025	<.75
			Cast Iron	<3D	1911	591	12229	0.040	0.025	<.75
				3D-5D	1486	459	7134	0.040	0.025	<.75
				5D-7D	1380	427	6624	0.040	0.025	<.75
				>7D	955	295	4586	0.040	0.025	<.75
HFSC-1500/4	HFCl-1204	HSN-XRN	Alloy Steel <32HRC	<3D	1441	623	8644	0.040	0.025	<.1
				3D-5D	1062	459	3822	0.040	0.025	<.1
				5D-7D	986	427	3549	0.040	0.025	<.1
				>7D	682	295	2457	0.040	0.025	<.1
			Alloy Steel 32-42HRC	<3D	1213	525	7279	0.040	0.025	<.1
				3D-5D	986	427	3549	0.040	0.025	<.1
				5D-7D	910	394	3276	0.040	0.025	<.1
				>7D	682	295	2457	0.040	0.025	<.1
			Tool Steel 42-52HRC	<3D	1062	459	5945	0.040	0.025	<.1
				3D-5D	758	328	2426	0.040	0.025	<.1
				5D-7D	758	328	2426	0.040	0.025	<.1
				>7D	682	295	1638	0.040	0.025	<.1
			Cast Iron	<3D	1365	591	9827	0.040	0.025	<.1
				3D-5D	1062	459	5945	0.040	0.025	<.1
				5D-7D	986	427	5520	0.040	0.025	<.1
				>7D	682	295	3822	0.040	0.025	<.1

High Feed Indexable Milling Program Tools

Cutting Conditions Data

Cutter	Insert	Grade	Work Piece Material	Overhang	n	Vc	Vf	fz	Ap	Ae
					RPM	sfm	Max RPM	inch/tooth	inch	inch
HFSS-1000-5.5-1000 HFSS-1000-7.0-1000	HFCI-09T3	HSN-XRN	Alloy Steel <32HRC	<3D	2420	623	11618	0.040	0.025	<.75
				3D-5D	1783	459	5350	0.040	0.025	<.75
				5D-7D	1656	427	4968	0.040	0.025	<.75
				>7D	1146	295	3439	0.040	0.025	<.75
			Tool Steel 32-42HRC	<3D	2038	525	9783	0.040	0.025	<.75
				3D-5D	1656	427	4968	0.040	0.025	<.75
				5D-7D	1529	394	4586	0.040	0.025	<.75
				>7D	1146	295	3439	0.040	0.025	<.75
			Tool Steel 42-52HRC	<3D	1783	459	7490	0.040	0.025	<.75
				3D-5D	1274	328	3057	0.040	0.025	<.75
				5D-7D	1274	328	3057	0.040	0.025	<.75
				>7D	1146	295	2064	0.040	0.025	<.75
			Cast Iron	<3D	2293	591	11006	0.040	0.025	<.75
				3D-5D	1783	459	6420	0.040	0.025	<.75
				5D-7D	1656	427	5962	0.040	0.025	<.75
				>7D	1146	295	4127	0.040	0.025	<.75
HFSS-1250-6.0-1250 HFSS-1250-8.0-1250	HFCI-09T3	HSN-XRN	Alloy Steel <32HRC	<3D	2017	623	12102	0.040	0.025	<.75
				3D-5D	1486	459	5350	0.040	0.025	<.75
				5D-7D	1380	427	4968	0.040	0.025	<.75
				>7D	896	295	3225	0.040	0.025	<.75
			Tool Steel 32-42HRC	<3D	1699	525	10191	0.040	0.025	<.75
				3D-5D	1380	427	4968	0.040	0.025	<.75
				5D-7D	1274	394	4586	0.040	0.025	<.75
				>7D	896	295	3225	0.040	0.025	<.75
			Tool Steel 42-52HRC	<3D	1486	459	7134	0.040	0.025	<.75
				3D-5D	1062	328	3397	0.040	0.025	<.75
				5D-7D	1062	328	2548	0.040	0.025	<.75
				>7D	896	295	2150	0.040	0.025	<.75
			Cast Iron	<3D	1911	591	12229	0.040	0.025	<.75
				3D-5D	1486	459	7134	0.040	0.025	<.75
				5D-7D	1380	427	6624	0.040	0.025	<.75
				>7D	896	295	4299	0.040	0.025	<.75
HFSS-1500-6.0-1500 HFSS-1500-9.0-1500	HFCI-1204	HSN-XRN	Alloy Steel <32HRC	<3D	1441	623	8644	0.040	0.040	<1
				3D-5D	1062	459	3822	0.040	0.040	<1
				5D-7D	986	427	3549	0.040	0.040	<1
				>7D	717	295	2580	0.040	0.040	<1
			Tool Steel 32-42HRC	<3D	1213	525	7279	0.040	0.040	<1
				3D-5D	986	427	3549	0.040	0.040	<1
				5D-7D	910	394	3276	0.040	0.040	<1
				>7D	717	295	2580	0.040	0.040	<1
			Tool Steel 42-52HRC	<3D	1062	459	5945	0.040	0.040	<1
				3D-5D	758	328	2426	0.040	0.040	<1
				5D-7D	758	328	2426	0.040	0.040	<1
				>7D	717	295	1720	0.040	0.040	<1
			Cast Iron	<3D	1365	591	9827	0.040	0.040	<1
				3D-5D	1062	459	5945	0.040	0.040	<1
				5D-7D	986	427	5520	0.040	0.040	<1
				>7D	717	295	4013	0.040	0.040	<1

High Feed Indexable Milling Program Tools

Cutting Conditions Data

Cutter	Insert	Grade	Work Piece Material	Overhang	n	Vc	Vf	fz	Ap	Ae
					RPM	sfm	Max RPM	inch/tooth	inch	inch
HFA-1500/4	HFCI-1204	HSN-XRN	Alloy Steel <32HRC	<3D	1441	623	8644	0.040	0.040	<1
				3D-5D	1062	459	3822	0.040	0.040	<1
				5D-7D	986	427	3549	0.040	0.040	<1
				>7D	682	295	2457	0.040	0.040	<1
			Tool Steel 32-42HRC	<3D	1213	525	7279	0.040	0.040	<1
				3D-5D	986	427	3549	0.040	0.040	<1
				5D-7D	910	394	3276	0.040	0.040	<1
				>7D	682	295	2457	0.040	0.040	<1
			Tool Steel 42-52HRC	<3D	1062	459	5945	0.040	0.040	<1
				3D-5D	758	328	2426	0.040	0.040	<1
				5D-7D	758	328	2426	0.040	0.040	<1
				>7D	682	295	1638	0.040	0.040	<1
			Cast Iron	<3D	1365	591	9827	0.040	0.040	<1
				3D-5D	1062	459	5945	0.040	0.040	<1
				5D-7D	986	427	5520	0.040	0.040	<1
				>7D	682	295	3822	0.040	0.040	<1
HFA-2000/5	HFCI-1204	HSN-XRN	Alloy Steel <32HRC	<3D	1210	623	8471	0.040	0.040	<1.375
				3D-5D	892	459	4459	0.040	0.040	<1.375
				5D-7D	828	427	4140	0.040	0.040	<1.375
				>7D	573	295	2293	0.040	0.040	<1.375
			Tool Steel 32-42HRC	<3D	1019	525	6115	0.040	0.040	<1.375
				3D-5D	828	427	4140	0.040	0.040	<1.375
				5D-7D	764	394	3822	0.040	0.040	<1.375
				>7D	573	295	2293	0.040	0.040	<1.375
			Tool Steel 42-52HRC	<3D	892	459	5350	0.040	0.040	<1.375
				3D-5D	637	328	2548	0.040	0.040	<1.375
				5D-7D	637	328	2548	0.040	0.040	<1.375
				>7D	573	295	2293	0.040	0.040	<1.375
			Cast Iron	<3D	1146	591	9172	0.040	0.040	<1.375
				3D-5D	892	459	5350	0.040	0.040	<1.375
				5D-7D	828	427	4968	0.040	0.040	<1.375
				>7D	573	295	3439	0.040	0.040	<1.375
HFA-2500/6	HFCI-1204	HSN-XRN	Alloy Steel <32HRC	<3D	917	623	7701	0.040	0.040	<1.8
				3D-5D	676	459	4053	0.040	0.040	<1.8
				5D-7D	627	427	3764	0.040	0.040	<1.8
				>7D	434	295	2085	0.040	0.040	<1.8
			Tool Steel 32-42HRC	<3D	772	525	5559	0.040	0.040	<1.8
				3D-5D	627	427	3764	0.040	0.040	<1.8
				5D-7D	579	394	3474	0.040	0.040	<1.8
				>7D	434	295	2085	0.040	0.040	<1.8
			Tool Steel 42-52HRC	<3D	676	459	4864	0.040	0.040	<1.8
				3D-5D	483	328	2316	0.040	0.040	<1.8
				5D-7D	483	328	2316	0.040	0.040	<1.8
				>7D	434	295	2085	0.040	0.040	<1.8
			Cast Iron	<3D	869	591	8338	0.040	0.040	<1.8
				3D-5D	676	459	4864	0.040	0.040	<1.8
				5D-7D	627	427	4517	0.040	0.040	<1.8
				>7D	434	295	3127	0.040	0.040	<1.8

High Performance Solid Carbide End Mills

Millstar offers a wide variety of Solid Carbide End Mills that are designed for high performance machining. Our impressive lineup features a large selection of High Feed Solid Carbide End Mills that achieve the highest performance in the industry. Our End Mills can be used in a broad spectrum of materials such as hardened steels, soft steels, titanium, cobalt chrome and many more.



Solid Carbide End Mill Program Tool Contents

High Feed

HF14	High Feed Four Flute Solid Carbide	42	
HF16	High Feed with Coolant Through 6 Flute	42	
Cutting Conditions		42	
Quad Force		43	

Square

EIS	Square	44	
EIS2	2 Flute – Square	44	
EIS2...LL	2 Flute Long Series – Square	44	
EIS4	4 Flute – Square	45	
EIS4...LL	4 Flute Long Series – Square	45	
EISA	3 Flute – 45°	45	
EIV4	4 Flute Variable – Square, 45° Chamfer	45	
EIV5	5 Flute Variable Square End	46	
EIV5	5 Flute Variable With Corner Radius	46	

Ball Nose

BI	Ball	47	
BI4T	Ball	47	
BI220	220° 2 Flute – Ball	47	
BI2	2 Flute – Long Series – Ball	48	
BI4	4 Flute – Long Series – Ball	48	
BIA	3 Flute – Ball 45°	48	

Bull Nose

EIB	Square–Bullnose	49	
------------	-----------------	----	---

Toroid

TO1	Toroid	49	
------------	--------	----	---

NA

Non-coated grade.

HSN

Millstar's new coating is a multi-layer hybrid Nano coating. This new coating has very good heat resistance and high hardness. The HSN coating is designed for use in HSM of Heat Treated materials up to 72 HRC.

**ALTiN-EXALON
(TLN) (EX)**

Titanium Aluminum Nitride advanced PVD coating. A special, improved ALTiN coating approaching surface hardness of CBN on a tough substrate. Recommended for tough and hard metal machining applications.

Custom tool coatings for specific applications are available by request.

Solid Carbide End Mills

Millstar's new High Performance and ultra-precise solid carbide end mills were designed for high speed, high velocity and hard steel milling. Designed with specially selected premium sub-micron carbide substrate, special tool geometry and proprietary heat-defying EXALON tool coating, these tools made in the United States, and are competitively priced. Ideal choices for accurately and aggressively machining products in:

- **Mold and die making:** injection molds, glass molds, forging dies, extrusion dies.
- **Aerospace:** engine, landing gear and tail hook components, structural components, blisks, airfoil machining and forging dies, helicopter rotor components.
- **Power generating:** turbine blades and other components.
- **Medical:** hip and knee replacement joints, surgical instruments, medical device molds.
- **Automotive:** stamping dies, wheel and tire molds, ball joints, cam shaft machining, racing engine details, bumper and other injection molds, die cast dies, forging dies for crank and cam shafts, connecting rods, steering knuckles and yokes.
- **Consumer products:** molds for cake forms and baking dishes, cell phones, lawn chairs, trash cans, toys, bottles, recyclable cutlery and dishes, jewelry, golf clubs, safety helmets, computer and accessory housings.

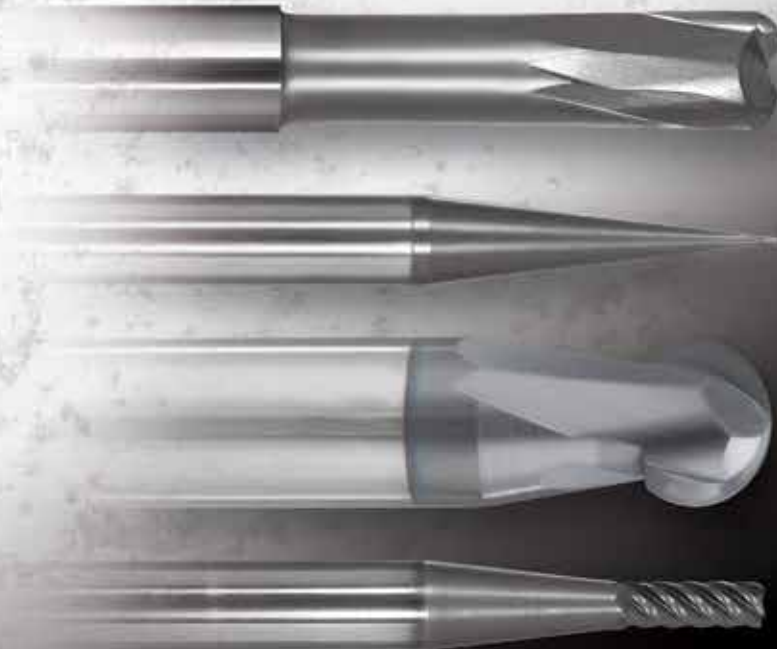

Solid Carbide End Mill Program - High Feed

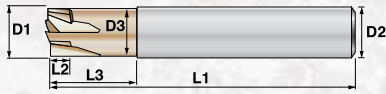

HF14 - High Feed Four Flute Solid Carbide

Tool Ordering No.	Diameter (D1)	Programmable Radius	Shank Diameter (D2)	Neck Diameter (D3)	Length of Cut (L2)	Neck Length (L3)	Overall Length (L1)	Step Over Ae	Depth of Cut Ap	Feed per Tooth Fz
HF14-0125	0.125	0.015	0.250	0.115	0.0938	0.650	3	0.094	0.005	0.003 - 0.006
HF14-0187	0.187	0.022	0.250	0.170	0.1250	0.750	3	0.135	0.007	0.004 - 0.009
HF14-0250	0.250	0.031	0.250	0.235	0.1500	1.000	3	0.187	0.009	0.006 - 0.011
HF14-0375	0.375	0.046	0.375	0.360	0.1700	1.250	4	0.280	0.014	0.009 - 0.016
HF14-0500	0.500	0.061	0.500	0.485	0.1800	1.500	4	0.375	0.019	0.012 - 0.022

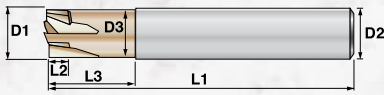

HF16 - High Feed Six Flute Solid Carbide with Coolant Through

Tool Ordering No.	Diameter (D1)	Programmable Radius	Shank Diameter (D2)	Neck Diameter (D3)	Length of Cut (L2)	Neck Length (L3)	Overall Length (L1)	Step Over Ae	Depth of Cut Ap	Feed per Tooth Fz
HF16-0250-3.0-CH	0.250	0.026	0.250	0.235	0.1560	0.5000	3	0.187	0.009	.006-.011
HF16-0312-3.0-CH	0.312	0.036	0.312	0.290	0.1560	0.5000	3	0.230	0.012	.007-.014
HF16-0375-3.0-CH	0.375	0.040	0.375	0.360	0.1875	0.5625	3	0.280	0.014	.009-.016
HF16-0500-4.0-CH	0.500	0.056	0.500	0.485	0.1875	0.5625	4	0.375	0.019	.012-.022
HF16-0625-4.0-CH	0.625	0.070	0.625	0.615	0.2180	0.6250	4	0.450	0.021	.015-.025

HF1 Cutting Conditions

Work Material	Material Hardness	Cutting Depth at Diameter ap max				Cutting Width Ae max	Coating type Recom.	Cut speed at D SFM	Max Feed per Tooth Fz at cutting insert diameter D			
		0.125	0.250	0.375	0.500				0.125	0.250	0.375	0.500
USA/W.-Nr./JIS	Hrc						Coating					
H13/1.2344/SKD61	<41	0.006	0.010	0.016	0.020	75%	HSN	800-1200	.003-.006	.006-.011	.009-.016	.012-.022
H13/1.2344/SKD61	41-50	0.006	0.010	0.016	0.020	75%	HSN	600-800	.003-.006	.006-.011	.009-.016	.012-.022
H13/1.2344/SKD61	51+	0.005	0.008	0.012	0.016	75%	HSN	300-600	.003-.006	.006-.011	.009-.016	.012-.022
A2/1,2363/SKD12	<41	0.006	0.010	0.016	0.020	75%	HSN	800-1200	.003-.006	.006-.011	.009-.016	.012-.022
A2/1,2363/SKD12	41-50	0.006	0.010	0.016	0.020	75%	HSN	800-1200	.003-.006	.006-.011	.009-.016	.012-.022
A2/1,2363/SKD12	51+	0.005	0.008	0.012	0.016	75%	HSN	300-600	.003-.006	.006-.011	.009-.016	.012-.022
P20/1,2330	<41	0.006	0.010	0.016	0.020	75%	HSN	800-1200	.003-.006	.006-.011	.009-.016	.012-.022
P20/1,2330	41-50	0.006	0.010	0.016	0.020	75%	HSN	800-1200	.003-.006	.006-.011	.009-.016	.012-.022
D2/1,2379/SKD11	<41	0.006	0.010	0.016	0.020	75%	HSN	800-1200	.003-.006	.006-.011	.009-.016	.012-.022
D2/1,2379/SKD11	41-50	0.006	0.010	0.016	0.020	75%	HSN	300-600	.003-.006	.006-.011	.009-.016	.012-.022
D2/1,2379/SKD11	51+	0.005	0.010	0.012	0.016	75%	HSN	250-500	.003-.006	.006-.011	.009-.016	.012-.022
Grey Cast Iron/GG	<41	0.006	0.010	0.016	0.020	75%	HSN	1000-3000	.003-.006	.006-.011	.009-.016	.012-.022
Cast Iron/GGG	41+	0.006	0.010	0.016	0.020	75%	HSN	800-1200	.003-.006	.006-.011	.009-.016	.012-.022
Titanium (6AL 4V)		0.006	0.010	0.016	0.020	75%	HSN	400-600	.003-.006	.006-.011	.009-.016	.012-.022

Solid Carbide End Mill Program - High Feed continued



Quad Force

Tool Ordering No.	Cutter Diameter (D1) Tol. +0/-0.0006	Programmable Radius (R1)	Shank Diameter (D2)	Cutting Length (L1)	Total Length (L2)
QFM-0125-HSN	1/8"	0.018"	0.125	0.500	1.500
QFM-0187-HSN	3/16"	0.021"	0.187	0.625	2.000
QFM-0250-HSN	1/4"	0.032"	0.250	0.750	2.500
QFM-0375-HSN	3/8"	0.140"	0.375	1.000	2.500
QFM-0500-HSN	1/2"	0.170"	0.500	1.200	3.000
QFM-0625-HSN	5/8"	0.200"	0.625	1.450	3.500
QFM-0750-HSN	3/4"	0.250"	0.750	1.700	4.000
QFM-1000-HSN	1"	0.310"	1.000	2.200	4.000



Quad Force Application Data

Side/Slot Milling		High Feed Machining		Trochoidal		Plunge Milling	
Tool	QFM-0375-HSN	Tool	QFM-0375-HSN	Tool	QFM-0375-HSN	Tool	QFM-0375-HSN
Tool Diameter	0.375"	Tool Diameter	0.375"	Tool Diameter	0.375"	Tool Diameter	0.375"
Spindle Speed	6265 RPM	Spindle Speed	6265 RPM	Spindle Speed	6265 RPM	Spindle Speed	6265 RPM
Feed Rate	225 IPM	Feed Rate	225 IPM	Feed Rate	225 IPM	Feed Rate	225 IPM
Depth of Cut	0.750"	Depth of Cut	0.012"	Depth of Cut	0.750"	Depth of Cut	0 - 0.750"
Width of Cut	0.012"	Width of Cut	0.225"	Width of Cut	0.012"	Width of Cut	0.012"
Metal Removal Rate	2.03	Metal Removal Rate	1.12	Metal Removal Rate	2.03	Metal Removal Rate	2.03
Material	P20	Material	P20	Material	P20	Material	P20



Side or Slot Milling

High Feed Machining

Trochoidal Milling

Plunge Milling

Solid Carbide End Mill Program - Square Nose

Square nose tools Series EMS / EIS with sharp corner or square nose tools Series EIB / EMB with corner radius, all with medium-high helix and strong cutting edges and tool body, work extremely well in materials up to 65HRc as well as in softer materials.

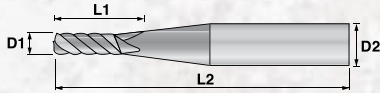

EIS - Square End

Tool Ordering No.	Cutter Diameter (D1) tol. +0 / -0.0004	Corner Radius	Shank Diameter (D2)	No. of Flutes	Neck Diameter	Cutting Length (L1)	Nose Taper	Overall Length (L2)
EIS-.020-	0.020	-	0.250 / (1/4)	3	0.020	0.060	7.500° / side	2.500
EIS-.031-	0.031 / (1/32)	-	0.250 / (1/4)	3	0.031	0.100	7.500° / side	2.500
EIS-.062-	0.062 / (1/16)	-	0.250 / (1/4)	4	0.062	0.200	7.500° / side	2.500
EIS-.093-	0.093 / (3/32)	-	0.250 / (1/4)	4	0.093	0.300	7.500° / side	2.500
EIS-.125-	0.125 / (1/8)	-	0.250 / (1/4)	5	0.125	0.375	7.500° / side	3.000
EIS-.187-	0.187 / (3/16)	-	0.250 / (1/4)	6	0.187	0.600	7.500° / side	3.000
EIS-.250-	0.250 / (1/4)	-	0.250 / (1/4)	6	0.250	0.750	-	3.000
EIS-.312-	0.312 / (5/16)	-	0.312 / (5/16)	6	0.312	1.000	-	3.500
EIS-.375-	0.375 / (3/8)	-	0.375 / (3/8)	6	0.375	1.125	-	3.500
EIS-.437-	0.437 / (7/16)	-	0.437 / (7/16)	6	0.437	1.315	-	4.000
EIS-.500-	0.500 / (1/2)	-	0.500 / (1/2)	6	0.500	1.500	-	4.000

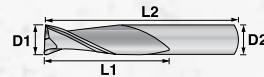
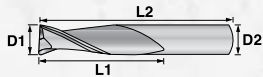

EIS2 - 2 Flute Endmill, Square End

Tool Ordering No.	Cutter Diameter (D1) tol. +0 / -0.0006	Corner Radius (R1)	Shank Dia. (D2)	Cutting Length (L1)	Total Length (L2)	Nose Taper Per Side
EIS2-031-	1/32"	XX	0.125	0.094	1.500	7.5 Deg
EIS2-062-	1/16"	XX	0.125	0.250	1.500	7.5 Deg
EIS2-093-	3/32"	XX	0.125	0.375	1.500	7.5 Deg
EIS2-0125-	1/8"	XX	0.125	0.500	1.500	-
EIS2-0187-	3/16"	XX	0.187	0.625	2.000	-
EIS2-0250-	1/4"	XX	0.250	0.750	2.500	-
EIS2-0312-	5/16"	XX	0.312	0.750	2.500	-
EIS2-0375-	3/8"	XX	0.375	0.875	2.500	-
EIS2-0437-	7/16"	XX	0.437	0.875	2.500	-
EIS2-0500-	1/2"	XX	0.500	1.250	3.000	-
EIS2-0625-	5/8"	XX	0.625	1.250	3.500	-
EIS2-0750-	3/4"	XX	0.750	1.500	4.000	-
EIS2-0875-	7/8"	XX	0.875	1.500	4.000	-
EIS2-1000-	1"	XX	1.000	1.500	4.000	-

EIS2...LL - 2 Flute Long Series Endmill, Sq. End

Tool Ordering No.	Cutter Diameter (D1) tol. +0 / -0.0006	Corner Radius (R1)	Shank Diameter (D1)	Cutting Length (L1)	Total Length (L2)
EIS2-0125-LL	1/8"	XX	0.125	0.625	2.000
EIS2-0187-LL	3/16"	XX	0.187	1.000	3.000
EIS2-0250-LL	1/4"	XX	0.250	1.000	3.000
EIS2-0312-LL	5/16"	XX	0.312	1.000	3.000
EIS2-0375-LL	3/8"	XX	0.375	1.000	4.000
EIS2-0437-LL	7/16"	XX	0.437	1.000	4.000
EIS2-0500-LL	1/2"	XX	0.500	1.500	4.000
EIS2-0625-LL	5/8"	XX	0.625	2.000	6.000
EIS2-0750-LL	3/4"	XX	0.750	2.000	6.000
EIS2-1000-LL	1"	XX	1.000	2.000	6.000

All products on this page come in both TLN and HSN coatings.

Example: EIS-.020-TLN

Solid Carbide End Mill Program - Square Nose continued

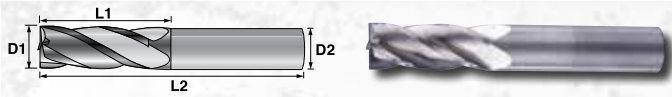

EIS4 - 4 Flute Endmill, Square End

Tool Ordering No.	Cutter Diameter (D1) tol. +0/-0.0006	Corner Radius (R1)	Shank Dia. (D1)	Cutting Length (L1)	Total Length (L2)	Nose Taper Per Side
EIS4-031-	1/32"	XX	0.125	0.094	1.500	7.5 Deg
EIS4-062-	1/16"	XX	0.125	0.250	1.500	7.5 Deg
EIS4-093-	3/32"	XX	0.125	0.375	1.500	7.5 Deg
EIS4-0125-	1/8"	XX	0.125	0.500	1.500	-
EIS4-0187-	3/16"	XX	0.187	0.625	2.000	-
EIS4-0250-	1/4"	XX	0.250	0.750	2.500	-
EIS4-0312-	5/16"	XX	0.312	0.750	2.500	-
EIS4-0375-	3/8"	XX	0.375	0.875	2.500	-
EIS4-0437-	7/16"	XX	0.437	0.875	2.500	-
EIS4-0500-	1/2"	XX	0.500	1.250	3.000	-
EIS4-0625-	5/8"	XX	0.625	1.250	3.500	-
EIS4-0750-	3/4"	XX	0.750	1.500	4.000	-
EIS4-0875-	7/8"	XX	0.875	1.500	4.000	-

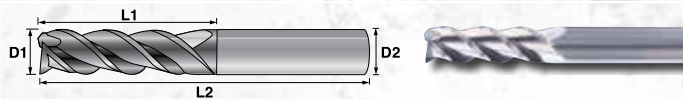

AlumiSTAR EISA - 3 Flute Endmill 45° - Aluminum

Tool Ordering No.	Cutter Diameter (D1) tol. +0/-0.0006	Corner Radius (R1)	Shank Diameter (D2)	Cutting Length (L1)	Total Length (L2)
EISA-0125-	1/8"	XX	0.125	0.500	1.500
EISA-0187-	3/16"	XX	0.187	0.625	2.000
EISA-0250-	1/4"	XX	0.250	0.750	2.500
EISA-0312-	5/16"	XX	0.312	0.750	2.500
EISA-0375-	3/8"	XX	0.375	0.875	2.500
EISA-0437-	7/16"	XX	0.437	0.875	2.500
EISA-0500-	1/2"	XX	0.500	1.250	3.000
EISA-0625-	5/8"	XX	0.625	1.250	3.500
EISA-0750-	3/4"	XX	0.750	1.500	4.000
EISA-1000-	1"	XX	1.000	1.500	4.000

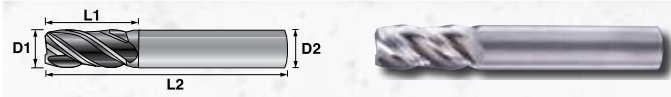

EIS4...LL - 4 Flute Long Series Endmill, Sq. End

Tool Ordering No.	Cutter Diameter (D1) tol. +0/-0.0006	Corner Radius (R1)	Shank Diameter (D2)	Cutting Length (L1)	Total Length (L2)
EIS4-0125-LL-	1/8"	XX	0.125	0.625	2.000
EIS4-0187-LL-	3/16"	XX	0.187	1.000	3.000
EIS4-0250-LL-	1/4"	XX	0.250	1.000	3.000
EIS4-0312-LL-	5/16"	XX	0.312	1.000	3.000
EIS4-0375-LL-	3/8"	XX	0.375	1.000	4.000
EIS4-0437-LL-	7/16"	XX	0.437	1.000	4.000
EIS4-0500-LL-	1/2"	XX	0.500	1.500	4.000
EIS4-0625-LL-	5/8"	XX	0.625	2.000	6.000
EIS4-0750-LL-	3/4"	XX	0.750	2.000	6.000
EIS4-1000-LL-	1"	XX	1.000	2.000	6.000



EIV4 - 4 Flute Variable Fluted Endmill, Square End w/45° Chamfer

Tool Ordering No.	Cutter Diameter (D1) tol. +0/-0.0006	Corner Radius (R1)	Shank Diameter (D2)	Cutting Length (L1)	Total Length (L2)
EIV4-0125-	1/8"	XX	0.125	0.500	1.500
EIV4-0187-	3/16"	XX	0.187	0.625	2.00
EIV4-0250-	1/4"	XX	0.250	0.750	2.500
EIV4-0312-	5/16"	XX	0.312	0.750	2.500
EIV4-0375-	3/8"	XX	0.375	0.875	2.500
EIV4-0437-	7/16"	XX	0.437	0.875	2.500
EIV4-0500-	1/2"	XX	0.500	1.250	3.000
EIV4-0625-	5/8"	XX	0.625	1.250	3.500
EIV4-0750-	3/4"	XX	0.750	1.500	4.000
EIV4-1000-	1"	XX	1.000	1.500	4.000

All products on this page come in both TLN and HSN coatings.

Example: **EISA-.0125-TLN**

Solid Carbide End Mill Program - Square Nose continued

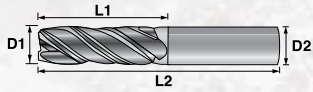

EIV5 - 5 Flute Variable Flute, Variable Helix Endmill, Square End

Tool Ordering No.	Cutter Dia. (D1) tol. +0/-0.001	Corner Radius (R1)	No. of Flutes	Shank Dia. (D2)	Cutting Length (L1)	Total Length (L2)
EIV5-.125-HSN	0.125	XX	5	0.125	0.313	1.500
EIV5-.125-.250-HSN	0.125	XX	5	0.250	0.313	3.000
EIV5-.250-HSN	0.250	XX	5	0.250	0.625	2.500
EIV5-.375-HSN	0.375	XX	5	0.375	0.938	2.500
EIV5-.500-HSN	0.500	XX	5	0.500	1.250	3.000
EIV5-.625-HSN	0.625	XX	5	0.625	1.563	3.500

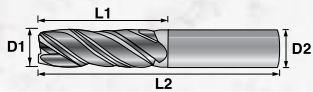

EIV5 - 5 Flute Variable Flute, Variable Helix Endmill, With Corner Radius

Tool Ordering No.	Cutter Dia. (D1) tol. +0/-0.001	Corner Radius (R1)	No. of Flutes	Shank Dia. (D2)	Cutting Length (L1)	Total Length (L2)
EIV5-.125-.015-HSN	0.125	0.015	5	0.125	0.313	1.500
EIV5-.250-.015-HSN	0.250	0.015	5	0.250	0.625	2.500
EIV5-.250-.030-HSN	0.250	0.030	5	0.250	0.625	2.500
EIV5-.375-.015-HSN	0.375	0.015	5	0.375	0.938	2.500
EIV5-.375-.030-HSN	0.375	0.030	5	0.375	0.938	2.500
EIV5-.500-.015-HSN	0.500	0.015	5	0.500	1.250	3.000
EIV5-.500-.030-HSN	0.500	0.030	5	0.500	1.250	3.000
EIV5-.500-.060-HSN	0.500	0.060	5	0.500	1.250	3.000
EIV5-.625-.015-HSN	0.625	0.015	5	0.625	1.563	3.500
EIV5-.625-.030-HSN	0.625	0.030	5	0.625	1.563	3.500
EIV5-.625-.060-HSN	0.625	0.060	5	0.625	1.563	3.500

Solid Carbide End Mill Program - Ball Nose

Ball nose tools Series BI / BM are designed with two flutes and special nose geometry for true High Speed and Hard Material milling up to 68 HRC. Ball nose tools are the most aggressive tools for these applications. We will be glad to share our proven approach to improving your machining results.

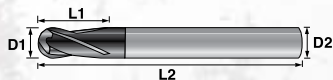

BI - Ball Nose

Tool Ordering No.	Cutter Diameter (D1) tol. +0 / -0.0004	Ball Radius	Shank Diameter (D2)	No. of Flutes	Neck Diameter	Cutting Length (L1)	Nose Taper	Overall Length (L2)
BI-.020	0.020	0.010	0.250 / (1/4)	2	-	0.020	7.500° / side	2.500
BI-.031	0.031 / (1/32)	0.015	0.250 / (1/4)	2	-	0.070	7.500° / side	2.500
BI-.062	0.062 / (1/16)	0.031	0.250 / (1/4)	2	-	0.062	7.500° / side	2.500
BI-.090	0.090	0.045	0.250 / (1/4)	2	-	0.090	7.500° / side	2.500
BI-.093	0.093 / (3/32)	0.046	0.250 / (1/4)	2	-	0.093	7.500° / side	2.500
BI-.125	0.125 / (1/8)	0.062	0.250 / (1/4)	2	-	0.125	7.500° / side	3.000
BI-.125-2.5-.125	0.125 / (1/8)	0.062	0.125 / (1/8)	2	-	0.125	NA	2.500
BI-.187	0.187 / (3/16)	0.093	0.250 / (1/4)	2	-	0.187	7.500° / side	3.000
BI-.187-2.5-.187	0.187 / (3/16)	0.093	0.187 / (3/16)	2	-	0.187	NA	2.500
BI-.250	0.250 / (1/4)	0.125	0.250 / (1/4)	2	-	0.250	-	3.000
BI-.312	0.312 / (5/16)	0.156	0.312 / (5/16)	2	-	0.312	-	3.500
BI-.375	0.375 / (3/8)	0.187	0.375 / (3/8)	2	-	0.375	-	3.500
BI-.375-LL	0.375 / (3/8)	0.187	0.375 / (3/8)	2	-	0.375	-	4.000
BI-.437	0.437 / (7/16)	0.218	0.437 / (7/16)	2	-	0.437	-	4.000
BI-.500	0.500 / (1/2)	0.250	0.500 / (1/2)	2	-	0.500	-	4.000

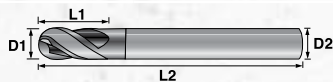

BI4T - Ball Nose, Special Tip Design for HSM

Tool Ordering No.	Cutter Diameter (D1) tol. +0 / -0.0004	Shank Diameter (D2)	Cutting Length (L1)	Overall Length (L2)
BI4T-.062	0.062	0.125	0.125	2.000
BI4T-.125	0.125	0.125	0.250	2.000
BI4T-.187	0.187	0.250	0.375	3.000
BI4T-.250	0.250	0.250	0.500	3.000
BI4T-.375	0.375	0.375	0.750	3.500
BI4T-.500	0.500	0.500	1.000	4.000

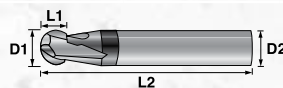

BI220 - 220° 2 Flute Endmill, Ball Nose

Tool Ordering No.	Cutter Diameter (D1) tol. +0 / -0.0006	Corner Radius (R1)	Shank Diameter (D2)	Cutting Length (L1)	Total Length (L2)
BI220-0125-	1/8	0.125	0.125	0.0938	1.500
BI220-0187-	3/16	0.093	0.187	0.141	2.000
BI220-0250-	1/4	0.125	0.250	0.188	2.500
BI220-0312-	5/16	0.156	0.312	0.234	2.500
BI220-0375-	3/8	0.187	0.375	0.281	2.500
BI220-0437-	7/16	0.218	0.437	0.328	2.500
BI220-0500-	1/2	0.250	0.500	0.375	3.000

All products on these pages come in both TLN and HSN coatings.

Example: BI4T-.062-HSN

Solid Carbide End Mill Program - Ball Nose continued



BI2 - 2 Flute Long Series Endmill, Ball Nose

Tool Ordering No.	Cutter Diameter (D1) tol. +0 / -0.0006	Corner Radius (R1)	Shank Diameter (D2)	Cutting Length (L1)	Total Length (L2)
BI2-0125-LL	1/8"	0.063"	0.125	0.625	2.000
BI2-0187-LL	3/16"	0.094"	0.187	1.000	3.000
BI2-0250-LL	1/4"	0.125"	0.250	1.000	3.000
BI2-0312-LL	5/16"	0.156"	0.312	1.000	3.000
BI2-0375-LL	3/8"	0.188"	0.375	1.000	4.000
BI2-0437-LL	7/16"	0.219"	0.437	1.000	4.000
BI2-0500-LL	1/2"	0.250"	0.500	1.000	4.000
BI2-0625-LL	5/8"	0.313"	0.625	2.000	6.000
BI2-0750-LL	3/4"	0.375"	0.750	2.000	6.000
BI2-1000-LL	1"	0.500"	1.000	2.000	6.000



BI4 - 4 Flute Endmill Long Series, Ballnose

Tool Ordering No.	Cutter Diameter (D1) tol. +0 / -0.0006	Corner Radius (R1)	Shank Diameter (D2)	Cutting Length (L1)	Total Length (L2)
BI4-0125-LL	1/8"	0.063"	0.125	0.625	2.000
BI4-0187-LL	3/16"	0.094"	0.187	1.000	3.000
BI4-0250-LL	1/4"	0.125"	0.250	1.000	3.000
BI4-0312-LL	5/16"	0.156"	0.312	1.000	3.000
BI4-0375-LL	3/8"	0.188"	0.375	1.000	4.000
BI4-0437-LL	7/16"	0.219"	0.437	1.000	4.000
BI4-0500-LL	1/2"	0.250"	0.500	1.000	4.000
BI4-0625-LL	5/8"	0.313"	0.625	2.000	6.000
BI4-0750-LL	3/4"	0.375"	0.750	2.000	6.000
BI4-1000-LL	1"	0.500"	1.000	2.000	6.000

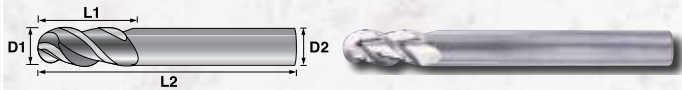

AlumiSTAR BIA - 3 Flute Endmill, Ball Nose 45° - Aluminum

Tool Ordering No.	Cutter Diameter (D1) tol. +0 / -0.0006	Corner Radius (R1)	Shank Diameter (D2)	Cutting Length (L1)	Total Length (L2)
BIA-0125-	1/8"	0.063"	0.125	0.500	1.500
BIA-0187-	3/16"	0.094"	0.187	0.625	2.000
BIA-0250-	1/4"	0.125"	0.250	0.750	2.500
BIA-0312-	5/16"	0.156"	0.312	0.750	2.500
BIA-0375-	3/8"	0.188"	0.375	0.875	2.500
BIA-0437-	7/16"	0.219"	0.437	0.875	2.500
BIA-0500-	1/2"	0.250"	0.500	1.250	3.000
BIA-0625-	5/8"	0.313"	0.625	1.250	3.500
BIA-0750-	3/4"	0.375"	0.750	1.500	4.000
BIA-1000-	1"	0.500"	1.000	1.500	4.000

All products on these pages come in both TLN and HSN coatings.

Example: BI2-0125-LL-TLN

Solid Carbide End Mill Program - Bull Nose

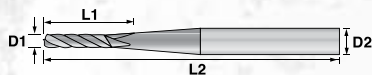

EIB - Square End Bull Nose w/Corner Radius

Tool Ordering No.	Cutter Diameter (D1) tol. +0 / -0.0004	Corner Radius	Shank Diameter (D2)	No. of Flutes	Neck Diameter	Cutting Length (L1)	Nose Taper	Overall Length (L2)
EIB-.062-015	0.062 / (1/16)	0.015	0.250 / (1/4)	4	0.062	0.200	7.500° / side	2.500
EIB-.093-015	0.093 / (3/32)	0.015	0.250 / (1/4)	4	0.093	0.300	7.500° / side	2.500
EIB-.125-015	0.125 / (1/8)	0.015	0.250 / (1/4)	5	0.125	0.375	7.500° / side	3.000
EIB-.125-030	0.125 / (1/8)	0.030	0.250 / (1/4)	5	0.125	0.375	7.500° / side	3.000
EIB-.187-030	0.187 / (3/16)	0.030	0.250 / (1/4)	6	0.187	0.600	7.500° / side	3.000
EIB-.250-015	0.250 / (1/4)	0.015	0.250 / (1/4)	6	0.250	0.750	-	3.000
EIB-.250-030	0.250 / (1/4)	0.030	0.250 / (1/4)	6	0.250	0.750	-	3.000
EIB-.312-030	0.312 / (5/16)	0.030	0.312 / (5/16)	6	0.312	1.000	-	3.500
EIB-.375-030	0.375 / (3/8)	0.030	0.375 / (3/8)	6	0.375	1.125	-	3.500
EIB-.437-030	0.437 / (7/16)	0.030	0.437 / (7/16)	6	0.437	1.315	-	4.000
EIB-.500-030	0.500 / (1/2)	0.030	0.500 / (1/2)	6	0.500	1.500	-	4.000
EIB-.500-060	0.500 / (1/2)	0.060	0.500 / (1/2)	6	0.500	1.500	-	4.000

Solid Carbide End Mill Program - Toroid

The Toroid Series TOI with large corner radius and slight back taper is a Millstar innovative addition. It is very useful in I.D. and O.D. Z-level and spiral milling at constant tool pressure, pocket milling, and milling of pre-hard and hardened flat surfaces at higher speeds than tools with smaller or sharp corner radii.

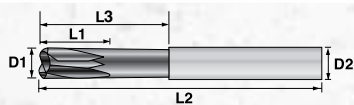

TOI - Toroid

Tool Ordering No.	Cutter Diameter (D1) tol. +0 / -0.0004	Corner Radius	Shank Diameter (D2)	No. of Flutes	Neck Diameter	Cutting Length (L1)	Nose Taper	Overall Length (L2)	Neck Length (L3)
TOI-125	0.125 / (1/8)	0.030	0.250 / (1/4)	2	0.115	0.125	0.375 / 7.500°	2.500	
TOI-250	0.250 / (1/4)	0.062	0.250 / (1/4)	2	0.230	0.250	0.750 / -	2.500	
TOI-375	0.375 / (3/8)	0.093	0.375 / (3/8)	2	0.345	0.375	1.125 / -	3.000	
TOI-500	0.500 / (1/2)	0.125	0.500 / (1/2)	2	0.460	0.500	1.500 / -	3.500	

All tools backdraft 3° per side

All products on these pages come in both TLN and HSN coatings.

Example: TOI-.125-TLN



SD Collet & HM Milling Chuck Contents

BT...SD

SD Collet High Accuracy Chucks

52



CT...SD



HSK...SD



HM

HM Milling Chucks

53



SD Collet Chuck

Measurement System	Interface	Collet Type	Gage Length
Imperial	CT40	SD-16	80mm
Metric	BT40	SD-16	90mm

HM Milling Chuck

Measurement System	Denoted Milling Chuck Size	Collet OD	Gage Length	Interface
Imperial	HM	32mm	4	CAT40
Metric	HM	32mm	105	BT40

SD Collet Chucks

CAT, BT and HSK styles:

- SD design increases gripping power/torque over the traditional ER collet system with 4° per side angle contact.
- Maximum runout (0.007mm @ 4XD) increases accuracy and tool life while minimizing rework. Consistent repeatability shortens set-up time and improves productivity.
- Off the shelf balance specifications of G6.3 at 20,000 rpm provides confidence in high speed machining applications and high accuracy requirements.
- Durable, case hardened chucks.

HM Milling Chucks

CAT, BT and HSK styles:

- More efficient & effective roughing operations.
- Exceptional rigidity under side loads.
- Strong chucking torque eliminates cutting tool slip and maximizes gripping power.
- Decreased vibration extends tool life and improves surface finishes for secondary operations.
- Superior concentric positioning improves accuracy and allows closer to net shape machining.
- Very competitively priced.



SD Collet Chucks

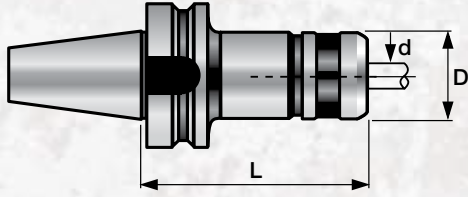

SD Collet Chucks (high accuracy)

Tool Ordering No.	Length L	Diameter D	Clamping Range d	Weight Kg
BT40-SD16-90	3.54 inch	1.6 inch	.098-.630 inch	1.3
BT50-SD16-100	4 inch	1.6 inch	.098-.630 inch	3.2

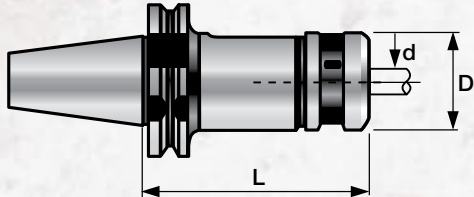

Note: Thread and Pilot are Metric DIN Standard

CT40-SD16-80	3.15 inch	1.6 inch	.098-.630 inch	1.3
CT50-SD16-100	4 inch	1.6 inch	.098-.630 inch	3.2

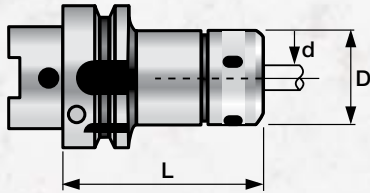

HSK63A-SD16-80	3.15 inch	1.6 inch	.098-.630 inch	1.1
HSK100A-SD16-100	4 inch	1.6 inch	.098-.630 inch	2.5

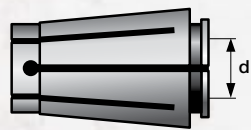

SD Collets

Tool Ordering No.	Range d	Tool Ordering No.	Range d	Tool Ordering No.	Range d	Tool Ordering No.	Range d
SD-16-3	.098-.118	SD-16-6.5	.236-.256	SD-16-10	.374-.394	SD-16-13.5	.512-.531
SD-16-3.5	.118-.1375	SD-16-7	.256-.276	SD-16-10.5	.394-.413	SD-16-14	.531-.551
SD-16-4	.1375-.157	SD-16-7.5	.276-.295	SD-16-11	.413-.433	SD-16-14.5	.551-.571
SD-16-4.5	.157-.177	SD-16-8	.295-.315	SD-16-11.5	.433-.453	SD-16-15	.571-.591
SD-16-5	.177-.197	SD-16-8.5	.315-.335	SD-16-12	.453-.472	SD-16-15.5	.591-.610
SD-16-5.5	.197-.217	SD-16-9	.335-.354	SD-16-12.5	.472-.492	SD-16-16	.610-.630
SD-16-6	.217-.236	SD-16-9.5	.354-.374	SD-16-13	.492-.512		



SD Clamping Nut

Tool Ordering No.	Length L	Diameter D
SD-16-Nut	24	41

SD Spanner Wrench

Tool Ordering No.	Length L	Diameter D
SD-S-16	170	41

BT SD • CT SD • HSK SD • SD Clamping Nut • SD Spanner Wrench

HM Milling Chucks

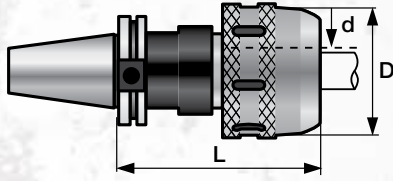

HM Milling Chucks

Tool Ordering No.	Length L	Diameter D	Diameter d	Clamping Range d	Weight Kg	Thread
HM32-4.0-CAT40	4.0 inch	2.89 inch	32mm	0.250-1.00"	2.4	
HM32-4.0-CAT50	4.0 inch	2.89 inch	32mm	0.250-1.00"	4.4	

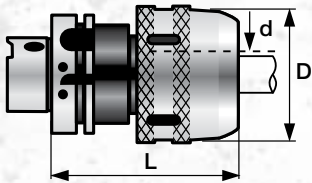

Tool Ordering No.	Length L	Diameter D	Diameter d	Clamping Range d	Weight Kg
HM32-100-HSK63A	4.0	2.89 inch	32mm	0.250-1.00"	2.1
HM32-100-HSK100A	4.0	2.89 inch	32mm	0.250-1.00"	3.4

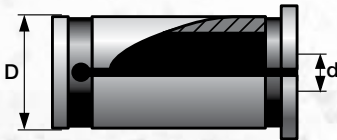

HMC Collets

Tool Ordering No.	Diameter D	Diameter d
HMC-32-.250	32mm	0.250
HMC-32-.375	32mm	0.375
HMC-32-.500	32mm	0.500
HMC-32-.625	32mm	0.625
HMC-32-.750	32mm	0.750
HMC-32-1.000	32mm	1.00



HM-S Spanner Wrench

Tool Ordering No.	Length L	Diameter D
HM-S-40	265	70

Metric Catalog Contents:

<i>Profile and Copy Milling Program</i>	<i>58</i>
<i>Graphite Machining Program</i>	<i>60</i>
<i>PCD & CBN Inserts</i>	<i>72</i>
<i>Copy Milling / Button Insert Cutters</i>	<i>78</i>
<i>APKT Square Shoulder Cutters</i>	<i>82</i>
<i>Aluminum Milling Cutters</i>	<i>84</i>
<i>High Feed Indexable Milling Program</i>	<i>88</i>
<i>Solid Carbide End Mill Program</i>	<i>98</i>
<i>SD Collet & HM Milling Chucks</i>	<i>118</i>



Millstar is an industry leader in producing die and mold profile tooling and solid carbide tools. Millstar tools are designed for conventional profile machining, and high speed and hard milling with modern machine tools and methods.

Millstar Profile Milling Tools represent the latest in profile and contour milling technology, resulting in shorter machining and lead times, higher machining accuracy and true contouring results.

Customers include die and mold machining companies, aluminum extrusion companies, high speed machining mold makers, and aerospace and medical component industries. Insert tooling is typically used in roughing and finishing applications.

The Millstar product line is manufactured in the USA, and all tools are fully traceable. Nearly six decades of cutting tool design and manufacturing for automotive, aerospace and many other industries, as well as special design capabilities using 3-D CAD allow us to respond quickly to requests for special designs.



Insert Overview

The Inserts

Millstar inserts are fully ground precision inserts for better chip control, faster metal removal and higher surface accuracies. They are far more accurate than pressed and O.D. sharpened inserts.

- Positive ground chipbreaker or strong negative cutting edge designs guarantee outstanding cutting performance in a wide variety of ferrous and non-ferrous materials.
- A choice of state-of-the-art insert grades, designs and tool coatings allow for optimum speed and feed rates in wet and dry machining. Reduced machining times by 25% to 60% are not uncommon.
- Economical one-piece inserts with two cutting edges are cost-effective for contour milling. True radius geometry is fully CNC-ground for higher machining accuracy and greatly reduced manual finishing and polishing time.

- Choose from side-cutting ball nose inserts with 180 degree nose radius, and popular ball nose inserts with a cutting edge covering 230 degrees for steep wall up-and-down ramping, profiling, contour milling and blending, and for a wider range of applications compared to conventional ball nose tools.
- Select from a variety of flat bottom, back draft and toroid inserts for steep or straight wall milling with long extensions on hard to reach cores, cavities or fillets. Milling with small radii prevents deflection and results in superior finishes and contour accuracies. Available with or without chipbreaker and coating in a variety of corner radii and sizes.

Rock Solid Insert Clamping

Cutting insert clamping is highly accurate and rigid. Unique V-pocket design gives a truly positive seat for the insert and will not allow insert movement when milling with a side thrust. "Sandwiched" insert clamping with single locking screw is unsurpassed for rigidity. The advanced design of Millstar inserts eliminates heat-seizing of locking screws or insert movement due to costly locating screws or pins of less advanced design. Positive V-pocket seating eliminates mismatch when changing to fresh inserts. It also eliminates the need to program new length or diameter offsets.

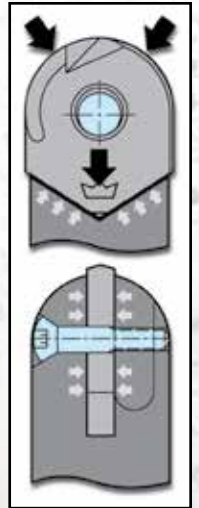

Ball Nose Inserts

MBT SuperFinisher Ball Nose Insert

Precision ground, harder grade, for semi-finish and finish milling. Excellent choice for unattended finish milling at small depth and high speeds and feed rates.



MB Ball Nose Insert

Unique cutting edge allows performance in all operations in material below 42 HRC; in semi, & finishing operations above. Significant benefits in chip evacuation. Insert geometry allows smoother cutting motion-diminishing heat build up & tool deflection, reduces vibration caused by cutting action.



VRBS Small Ball Nose Insert

Used for semi and finish-milling small radius or detail work, and surface milling in soft and hard steel, cast iron, aerospace and non-ferrous alloys, graphite, etc. Suitable for high speed and hard milling.



RB-N Ball Nose Insert

Precision ground, non-chipbreaker. Best choice for cavity, core and profile milling of pre-hard and fully hard die/mold steels, cast steels and cast iron. Strongest cutting edge design.



RBT Insert

Precision ground for semi-finish and finish milling. Excellent choice for unattended finish milling at small depth and high speed and feed rates.



BS-N Ball Nose Insert

Sidecutting, non-chipbreaker. Side cutting insert used in cavity and core profiling, for blending of fillets on medium and hard materials.



Flat Bottom Inserts

BDS Flat Bottom Insert

Precision ground, non-chipbreaker. Unique crossover design between flat bottom FB and back draft BD inserts. Allows straight walls with a larger step down than BD, but less cutting forces than FB; allows higher cutting speeds and feed



FB-R Flat Bottom Insert

Precision ground, with positive ground chipbreaker. Flat bottom insert for shoulder milling, fillet finishing and long reach angular wall finishing of softer materials



HF (High Feed) Inserts

Millstar's new HF insert is designed for High Speed and High Feed machining. The HF is designed to run at high cutting speeds and feed rates with shallow depth of cut. The NEW curved geometry allows the chip to flow up and out of the cut quickly and smoothly allowing for the use of heavy chip loads. The geometry of the new HF insert generates cutting forces upward, toward the spindle, which helps eliminate vibration and deflection, allowing for very high chip loads. The HF insert is designed to fit into Millstar's standard flat holders, style 4 (CYF, TAF and CBCYF) making these holders more versatile than ever.



Back Draft Inserts

BD-R Back Draft Insert

Precision ground, with positive ground chipbreaker and 7 degree back-taper. Used for milling of cores, cavities, fillets with straight or very steep walls of softer material.

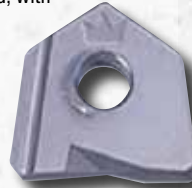

VBD Small Back Draft Insert

Used for semi and finish-milling small radius or detail work, and surface milling in soft and hard steel, cast iron, aerospace and non-ferrous alloys, graphite, etc. Suitable for high speed and hard milling.



BD-N Back Draft Insert

Precision ground, non-chipbreaker and 7 degree backtaper. Used for milling of cores, cavities, fillets with straight or very steep walls of harder material.

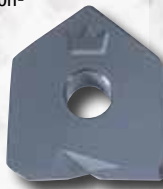

TOBD-NF Back Draft Inserts for Non-Ferrous Materials

Millstar's new TOBD-NF insert is specifically designed for high speed and high feed roughing of Aluminum, but also has the versatility to be used for fine finishing as well. This unique cutting edge design allows the chips to flow freely up the flute allowing higher speeds and feeds. The TOBD-NF comes in diameters from 1/2 inch (12mm) up to 1 inch (25mm) and fits into our standard flat type tool holders making the holders more versatile than ever.



CBN Tipped

For high speed machining or milling of high hardness materials with longer tool life and superior finishes.



PCD Tipped

For carbon milling with longer tool life.



Toroid

TO Toroid Bull Nose Insert

Precision ground, large corner radius & back taper for spiral and pocket milling, milling of pre-hard and hardened flat surfaces at higher speeds than tools with smaller corner radii. Good choice for HS milling of Aluminum

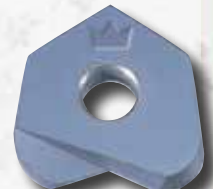



Profile Milling Program Tool Contents

VRBS, MBT, VBD, BDS	Graphite Machining Program	61	
SFCY	Cylindrical Steel Shank Holder – Ball	62	
SFTA	Taper Steel Shank Holder – Ball	62	
CYF	Cylindrical Steel Shank Holder – Flat	63	
TAF	Taper Steel Shank Holder – Flat	63	
TAV, CY, TA	Spike-Line Cylindrical Steel Shank	64	
CB SFCY	Cylindrical Carbide Shank Holder – Ball	64	
CB CYF	Cylindrical Carbide Shank Holder – Flat	65	
CB TAV	Spike-Line Taper Carbide Shank Holder – Ball & Flat	65	
CB TA	Taper Carbide Uni-Shank Holder – Ball & Flat	66	
CB CYV	Spike Line Taper Carbide Shank – Ball & Flat	66	
CB CY	Cylindrical Carbide Uni-Shank Holder – Ball & Flat	67	
CYFMK	Morse Steel Shank Holder – Flat	67	
CYMK	Morse Steel Shank Holder – Ball	68	
SF CY/CYF	Screw-on Head – Ball & Flat	68-69	
Solid Carbide Adaptor		69	
Inserts		70-73	
Cutting Parameters		74-75	
Verify Surface Roughness		76	
Feed & Speed Calculator		77	

Profile Milling Program Tools

Millstar Profile Milling Tools represent the latest in profile and contour milling technology, providing the competitive edge of shorter machining and lead times, and the advantages of higher machining accuracy and true contouring results.

The Millstar Advantage

Better surface finishes	=	Reduced finishing work
Faster run & feed speed	=	Reduced machining time
Increased tool life	=	Reduced tool changes & cost
Accurate and consistent milling	=	Reduced manual rework
Balanced milling action, two flute efficiency	=	Greatly increased metal removal productivity



Graphite Machining Program - True Diamond Coated Inserts

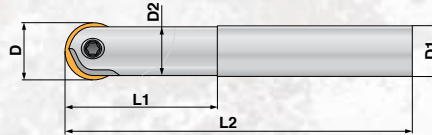

VRBS/RB - General Ball Nose Graphite Machining Line, Metric

Tool Ordering Number	Dimensions					Recommended Shank Part Number
	Size ØD	Shank ØD1	Neck ØD2	Neck Length L1	Total Length L2	
VRBS-6-DMD	6	6	5,7	30	115	CBCYV-06-115-06
VRBS-8-DMD	8	8	7,5	30	115	CBCYV-08-130-08
RB-10-N-DMD	10	10	9,0	32	150	CBCY-10-150-10
RB-12-N-DMD	12	12	10,8	52	165	CBSFCY-12-150-12
RB-16-N-DMD	16	16	14,4	52	170	CBSFCY-16-150-16
RB-20-N-DMD	20	20	18,0	77	225	CBSFCY-20-200-20
RB-25-N-DMD	25	25	22,5	93	230	CBSFCY-25-200-25
RB-30-N-DMD	30	30	27,2	57	230	CBSFCY-30/32-190-32
RB-32-N-DMD	32	32	27,2	57	230	CBSFCY-30/32-190-32

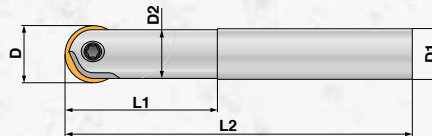

MBT - Ball Nose Graphite Finishing Line, Metric

Tool Ordering Number	Dimensions					Recommended Shank Part Number
	Size ØD	Shank ØD1	Neck ØD2	Neck Length L1	Total Length L2	
MBT-10-DMD	10	10	9,0	32	150	CBCY-10-150-10
MBT-12-DMD	12	12	10,8	52	165	CBSFCY-12-150-12
MBT-16-DMD	16	16	14,4	52	170	CBSFCY-16-150-16
MBT-20-DMD	20	20	18,0	77	225	CBSFCY-20-200-20
MBT-25-DMD	25	25	22,5	93	230	CBSFCY-25-200-25
MBT-30-DMD	30	30	27,2	57	230	CBSFCY-30/32-190-32
MBT-32-DMD	32	32	27,2	57	230	CBSFCY-30/32-190-32

* For other holder options, see page 62 (Metric).

Graphite Machining Program - True Diamond Coating or PCD Tipped

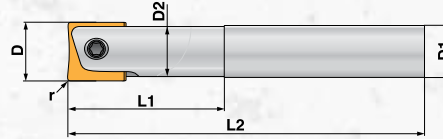
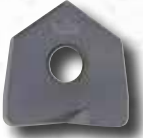

VBD/BDS - Flat Bottom Graphite Machining Line, Metric

Tool Ordering Number	Dimensions						Recommended Shank Part Number
	Size ØD	Radius	Shank ØD1	Neck ØD2	Neck Length L1	Total Length L2	
VBD-06-R0,1	6	0,1	6	5,7	30	115	CBCYV-06-115-06
VBD-06-R0,4	6	0,4	6	5,7	30	115	CBCYV-06-115-06
VBD-08-R0,1	8	0,1	8	7,5	30	115	CBCYV-08-130-08
VBD-08-R0,4	8	0,4	8	7,5	30	115	CBCYV-08-130-08
BDS-10-N-0.1	10	0,1	10	9,0	32	150	CBCY-10-150-10
BDS-10-N-0.8	10	0,8	10	9,0	32	150	CBCY-10-150-10
BDS-10-N-1.0	10	1,0	10	9,0	32	150	CBCY-10-150-10
BDS-12-N-0.1	12	0,1	12	10,8	52	165	CBCYF-12-150-12
BDS-12-N-1.0	12	1,0	12	10,8	52	165	CBCYF-12-150-12
BDS-16-N-0.1	16	0,1	16	14,4	52	170	CBCYF-16-150-16
BDS-16-N-1.0	16	1,0	16	14,4	52	170	CBCYF-16-150-16
BDS-16-N-1.3	16	1,3	16	14,4	52	170	CBCYF-16-150-16
BDS-20-N-0.1	20	0,1	20	18,0	77	225	CBCYF-20-200-20
BDS-20-N-1.0	20	1,0	20	18,0	77	225	CBCYF-20-200-20
BDS-20-N-1.6	20	1,6	20	18,0	77	225	CBCYF-20-200-20
BDS-25-N-1.0	25	1,0	25	22,5	93	230	CBCYF-25-200-25
BDS-25-N-2.0	25	2,0	25	22,5	93	230	CBCYF-25-200-25

* For other holder options, see page 62 (Metric).

Profile Milling Holders

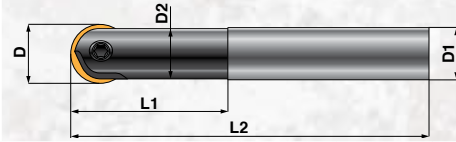

SFCY - Cylindrical Steel Shank Holder, Ball

Tool Ordering Number	Dimensions					Screw	Key	Use with Inserts	
	Size ØD	Shank ØD1	Neck ØD2	Neck Length L1	Total Length L2			Type	Code
SFCY-12-125-12	12	12	10,8	36	125	MS12	T20		MB, MBT, RB-N, BS-N, RBT
SFCY-12-150-12	12	12	10,8	46	150	MS12	T20		
SFCY-0500-6.0-12	0.5"	12	11,2	44	152	MS12	T20		
SFCY-14-125-16	14	16	12,6	36	125	MS16	T20		
SFCY-16-160-16	16	16	14,4	50	160	MS16	T20		
SFCY-20-150-20	20	20	18,0	50	150	MS20	T20		
SFCY-20-190-20	20	20	18,0	61	190	MS20	T20		
SFCY-22-200-25	22	25	19,8	50	200	MS25	T20		
SFCY-25-150-25	25	25	22,5	50	150	MS25	T20		
SFCY-25-200-25	25	25	22,5	64	200	MS25	T20		
SFCY-25-250-25	25	25	22,5	64	250	MS25	T20		
SFCY-1000-6.0-25	1.0"	25	22,5	44	152	MS25	T20		
SFCY-1000-10.0-25	1.0"	25	22,5	70	254	MS25	T20		
SFCY-30/32-190-32	30/32	32	27,2	57	190	MS32	T30		
SFCY-30/32-250-32	30/32	32	27,2	76	250	MS32	T30		
SFCY-30/32-300-32	30/32	32	27,2	57	300	MS32	T30		

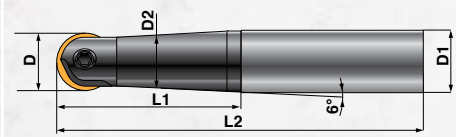

SFTA - Taper Steel Shank Holder, Ball

Tool Ordering Number	Dimensions					Screw	Key	Use with Inserts	
	Size ØD	Shank ØD1	Neck ØD2	Neck Length L1	Total Length L2			Type	Code
SFTA-12-190-16	12	16	10,8	60	190	MS12	T20		MB, MBT, RB-N, BS-N, RBT
SFTA-16-190-20	16	20	14,4	57	190	MS16	T20		
SFTA-20-200-25	20	25	18,0	80	200	MS20	T20		
SFTA-25-250-32	25	32	22,5	100	250	MS25	T20		
SFTA-25-315-32	25	32	22,5	100	315	MS25	T20		
SFTA-30/32-250-40	30/32	40	27,2	120	250	MS32	T30		
SFTA-30/32-250-42	30/32	42	27,2	120	250	MS32	T30		

Profile Milling Holders

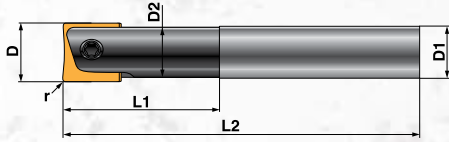

CYF - Cylindrical Steel Shank Holder, Flat

Tool Ordering Number	Dimensions					Screw	Key	Use with Inserts	
	Size ØD	Shank ØD1	Neck ØD2	Neck Length L1	Total Length L2			Type	Code
CYF-10-100-10	10	10	9,0	19	100	MS10	T15		BD-N, BD-R, BDS, FB-R, TO, TOBD-NF, HF
CYF-12-125-12	12	12	10,8	36	125	MS12	T20		
CYF-12-150-12	12	12	10,8	46	150	MS12	T20		
CYF-16-160-16	16	16	14,4	50	160	MS16	T20		
CYF-20-150-20	20	20	18,0	50	150	MS20	T20		
CYF-20-200-20	20	20	18,0	61	200	MS20	T20		
CYF-25-150-25	25	25	22,5	50	150	MS25	T20		
CYF-25-200-25	25	25	22,5	64	200	MS25	T20		
CYF-30/32-190-32	30/32	32	28,6	57	190	MS32	T30		
CYF-30/32-250-32	30/32	32	28,6	76	250	MS32	T30		

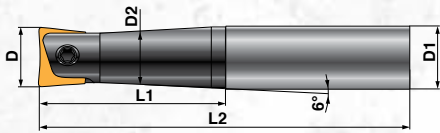

TAF - Taper Steel Shank Holder, Flat

Tool Ordering Number	Dimensions					Screw	Key	Use with Inserts	
	Size ØD	Shank ØD1	Neck ØD2	Neck Length L1	Total Length L2			Type	Code
TAF-10-150-12	10	12	9,0	35	150	MS10	T15		BD-N, BD-R, BDS, FB-R, TO, TOBD-NF, HF
TAF-12-190-16	12	16	10,8	60	190	MS12	T20		
TAF-16-190-20	16	20	14,4	57	190	MS16	T20		
TAF-20-200-25	20	25	18,0	80	200	MS20	T20		
TAF-25-250-32	25	32	22,5	100	250	MS25	T20		
TAF-25-315-32	25	32	22,5	100	315	MS25	T20		
TAF-30/32-250-40	30/32	40	28,6	120	250	MS32	T30		

Profile Milling Program Tools

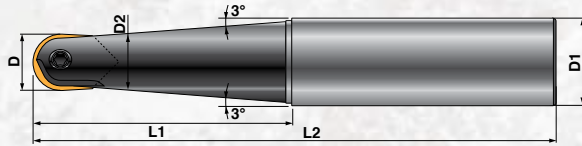

TAV, CY, TA - Spike-Line Cylindrical Steel Shank

Tool Ordering Number	Dimensions					Screw	Key	Use with Inserts	
	Size ØD	Shank ØD1	Neck ØD2	Neck Length L1	Total Length L2			Type	Code
TAV-06-095-12	6	12	5,7	30	95	MS06N	T7		VRBS, VBD
TAV-08-095-12	8	12	7,5	32	95	MS08N	T7		VRBS, VBD
CY-10-100-10	10	10	9,0	19	100	MS10	T15		VRBS, VBD, MB, MBT, RB-N, BS-N, BD, BDS, FB, TO, HF, RBT
CY-10-100-12	10	12	9,0	25	100	MS10	T15		
TA-10-125-12	10	12	9,0	35	125	MS10	T15		
TA-10-150-12	10	12	9,0	35	150	MS10	T15		

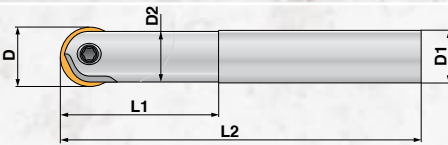

CB SFCY - Cylindrical Carbide Shank Holder, Ball

Tool Ordering Number	Dimensions					Screw	Key	Use with Inserts	
	Size ØD	Shank ØD1	Neck ØD2	Neck Length L1	Total Length L2			Type	Code
CBSFCY-12-150-12	12	12	10,8	52	165	MS12	T20		MB, MBT, RB-N, BS-N, RBT
CBSFCY-16-150-16	16	16	14,4	52	170	MS16	T20		
CBSFCY-20-200-20	20	20	18,0	77	225	MS20	T20		
CBSFCY-25-200-25	25	25	22,5	93	230	MS25	T20		
CBSFCY-30/32-190-32	30/32	32	27,2	57	230	MS32	T30		

Profile Milling Program Tools

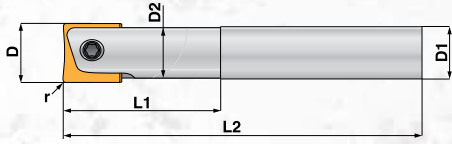

CB CYF - Cylindrical Carbide Shank Holder, Flat

Tool Ordering Number	Dimensions					Screw	Key	Use with Inserts	
	Size ØD	Shank ØD1	Neck ØD2	Neck Length L1	Total Length L2			Type	Code
CBCYF-12-150-12	12	12	10,8	52	165	MS12	T20		BD-N, BD-R, BDS, FB-R, TO, TOBD-NF, HF
CBCYF-16-150-16	16	16	14,4	52	170	MS16	T20		
CBCYF-20-200-20	20	20	18,0	77	225	MS20	T20		
CBCYF-25-200-25	25	25	22,5	93	230	MS25	T20		

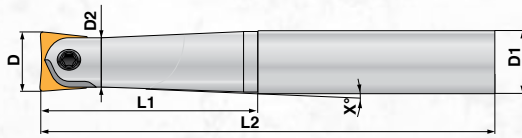

CB TAV - Spike-Line Taper Carbide Shank, Ball & Flat

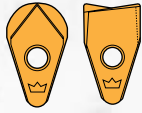
Tool Ordering Number	Dimensions					X°	Screw	Key	Use with Inserts	
	Size ØD	Shank ØD1	Neck ØD2	Neck Length L1	Total Length L2				Type	Code
CBTAV-06-075-12	6	12	5,7	35	75	6° (3°/side)	MS06N	T7		VRBS, VBD
CBTAV-06-150-12	6	12	5,7	30	155	6° (3°/side)	MS06N	T7		
CBTAV-06-150-12 LT	6	12	5,7	70	155	6° (3°/side)	MS06N	T7		
CBTAV-08-080-12	8	12	7,5	40	80	6° (3°/side)	MS08N	T7		
CBTAV-08-150-12	8	12	7,5	30	155	6° (3°/side)	MS08N	T7		

Profile Milling Program Tools

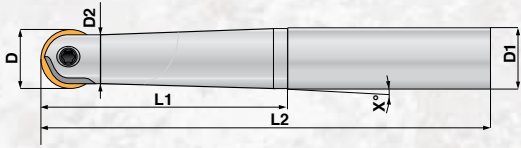

CB TA - Taper Carbide Uni-Shank Holder, Ball & Flat

Tool Ordering Number	Dimensions					X°	Screw	Key	Use with Inserts	
	Size ØD	Shank ØD1	Neck ØD2	Neck L1	Total L2				Type	Code
CBTA-10-150-12	10	12	9,0	30	165	6° (3° side)	MS10	T15		MB, MBT, RB-N, BS-N, BD, BDS, FB, TO, HF, RBT

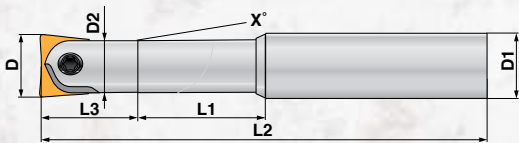

CB CYV - Spike Line Taper Carbide Shank, Ball & Flat

Tool Ordering Number	Dimensions						X°	Screw	Key	Use with Inserts	
	Size ØD	Shank ØD1	Neck ØD2	Neck L3	Neck L1	Total L2				Type	Code
CBCYV-06-115-12	6	12	5,7	30	45	115	1°	MS06N	T7		VRBS, VBD
CBCYV-08-100-12	8	12	7,5	30	30	100	1°	MS08N	T7		VRBS, VBD

Profile Milling Program Tools

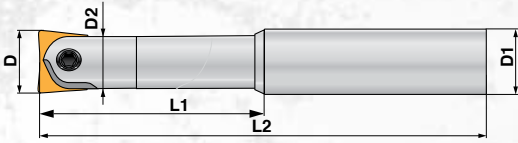

CB CY - Cylindrical Carbide Uni-Shank Holder, Ball & Flat

Tool Ordering Number	Dimensions					Screw	Key	Use with Inserts	
	Size ØD	Shank ØD1	Neck ØD2	Neck L1	Total L2			Type	Code
CBCYV-06-115-06	6	6	5,7	30	115	MS06N	T7		VRBS, VBD
CBCYV-08-130-08	8	8	7,5	30	130	MS08N	T7		
CBCY-10-150-10	10	10	9,0	32	150	MS10	T15		MB, MBT, RB-N, BS-N, BD, BDS, FB, TO, HF, RBT

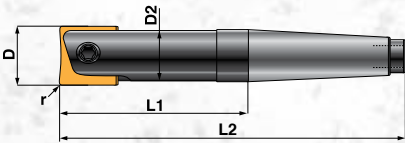

CYFMK - Morse Steel Shank Holder, Flat

Tool Ordering Number	Dimensions					Screw	Key	Use with Inserts	
	Size ØD	Shank ØD1	Neck L1	Total L2	MORSE			Type	Code
CYFMK-2-130-12	12	10,8	40	130	MK2	MS12	T20		BD-N, BD-R, BDS, FB-R, TO, TOBD-NF, HF
CYFMK-2-140-16	16	14,4	45	140	MK2	MS16	T20		
CYFMK-2-150-20	20	18,0	55	150	MK2	MS20	T20		
CYFMK-3-180-25	25	22,5	70	180	MK3	MS25	T20		
CYFMK-4-210-32	32	27,2	75	210	MK4	MS32	T30		

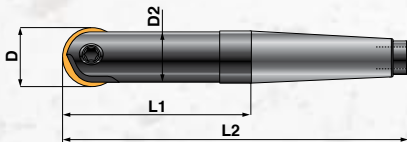

CYMK - Morse Steel Shank Holder, Ball

Tool Ordering Number	Dimensions					Screw	Key	Use with Inserts	
	Size ØD	Shank ØD1	Neck L1	Total L2	MORSE			Type	Code
CYMK-2-130-12	12	10,8	40	130	MK2	MS12	T20		MB, MBT, RB-N, BS-N, RBT
CYMK-2-140-16	16	14,4	45	140	MK2	MS16	T20		
CYMK-2-150-20	20	18,0	55	150	MK2	MS20	T20		
CYMK-3-180-25	25	22,5	70	180	MK3	MS25	T20		
CYMK-4-210-32	32	27,2	75	210	MK4	MS32	T30		

MILLSTAR.

Screw-On Heads



Modular Screw-On System

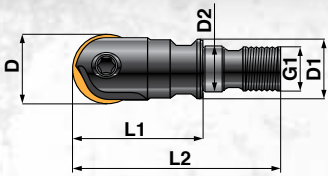

SF CY - Screw-on Head, Ball

Tool Ordering Number	Size ØD	Diameter D1	Diameter D2	Thread G1	Length L1	Length L2	Screw	Key	Use with Inserts	
									Type	Code
SFCY-10-SC-M6	10	9,8	6,5	M6	24	40	MS10	T15		MB, MBT, RB-N, BS-N, RBT
SFCY-12-SC-M6	12	10,8	6,5	M6	26	42	MS12	T20		
SFCY-16-SC-M8	16	15,0	8,5	M8	30	48	MS16	T20		
SFCY-20-SC-M10	20	18,0	10,5	M10	36	56	MS20	T20		
SFCY-25-SC-M12	25	22,5	12,5	M12	44	65	MS25	T20		
SFCY-32-SC-M16	32	28,6	17,0	M16	50	74	MS32	T30		

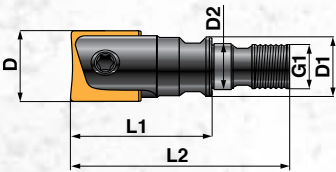

CYF - Screw-on Head, Flat

Tool Ordering Number	Size ØD	Diameter D1	Diameter D2	Thread G1	Length L1	Length L2	Screw	Key	Use with Inserts	
									Type	Code
CYF-10-SC-M6	10	9,8	6,5	M6	24	40	MS10	T15		BD-N, BD-R, BDS, FB-R, TO, TOBD-NF, HF
CYF-12-SC-M6	12	10,8	6,5	M6	26	42	MS12	T20		
CYF-16-SC-M8	16	15,0	8,5	M8	30	48	MS16	T20		
CYF-20-SC-M10	20	18,0	10,5	M10	36	56	MS20	T20		
CYF-25-SC-M12	25	22,5	12,5	M12	44	65	MS25	T20		
CYF-32-SC-M16	32	28,6	17,0	M16	50	74	MS32	T30		

Solid Carbide Adaptor

Tool Ordering Number	Size ØD1	Neck ØD2	Neck L1	Total L	Thread G1
CY-10-150-SC-M6	10	9,8	30	150	M6
CY-12-80-12-SC-M6	12	10,8	27	80	M6
CY-12-150-SC-M6	12	10,8	27	150	M6
CY-16-200-SC-M8	16	15,0	31	200	M8
CY-18-130-SC-M10-CH	18	-	-	130	M10
CY-18-190-SC-M10-CH	18	-	-	190	M10
CY-20-200-SC-M10	20	18,0	36	200	M10
CY-25-170-SC-106-M12	25	24	106	170	M12
CY-25-220-SC-156-M12	25	24	156	220	M12
CY-25-250-SC-M12	25	22,5	44	250	M12
CY-32-170-SC-106-M16	32	29	106	170	M16
CY-32-220-SC-156-M16	32	29	156	220	M16
CY-32-300-SC-M16	32	28,6	52	300	M16

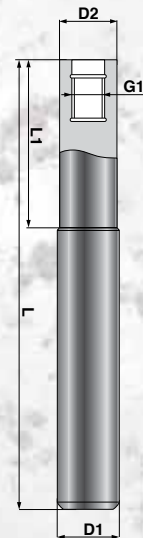

Profile Milling Inserts

Small Ball Nose & Back Draft Inserts

VRBS	Tool Ordering Number	Dimensions			Grade			Description
		D	L	R	XRN	TLN	HSN	
	VRBS-6	6	8,10	3	•	•	•	Used for semi and finish-milling small radius or detail work, and surface milling in soft and hard steel, cast iron, aerospace and non-ferrous alloys, graphite, etc. Suitable for high speed and hard milling.
	VRBS-8	8	4,50	4	•	•	•	
VBD	Tool Ordering Number	Dimensions			Grade			Description
		D	L	R	XRN	TLN	HSN	
	VBD-06	6	8,6	0,1/0,4	•	•	•	Used for semi and finish-milling small radius or detail work, and surface milling in soft and hard steel, cast iron, aerospace and non-ferrous alloys, graphite, etc. Suitable for high speed and hard milling.
	VBD-08	8	5	0,1/0,4	•	•	•	

Metric High Feed Inserts

HF	Tool Ordering Number	Dimensions			Grade			Description
		D	L	PR	XRN	TLN	HSN	
	HF-10	10	3	1,00	•	•	•	Millstar HF insert is designed for High feed and High speed machining. It runs at high cutting speed and feed rates with shallow depth of cut. It allows the chip to flow up and out of the cut quickly. It allows heavy chip loads.
	HF-12	12	4	1,43	•	•	•	
	HF-16	16	5	1,94	•	•	•	
	HF-20	20	6	2,26	•	•	•	
	HF-25	25	7	2,82	•	•	•	

Cutting Recommendations for High Feed Inserts

Work Material	Material Hardness	Cutting Depth at Diameter ap max					Cutting Width Ae max	Insert	Coating Type Recom.	Cut speed at D m/min	Max feed per tooth fz at cutting insert diameter D				
		10	12	16	20	25					10	12	16	20	25
H13/1,2344/SKD61	<41	0,38	0,46	0,61	0,76	0,95	60 - 75%	HF	XRN/HSN	157 - 218	0,28~0,48	0,36~0,56	0,051~0,71	0,66~0,86	0,85~1,05
H13/1,2344/SKD61	41-50	0,32	0,38	0,51	0,64	0,80	60 - 75%	HF	XRN/HSN	126 - 187	0,22~0,42	0,28~0,48	0,41~0,61	0,54~0,74	0,70~0,90
H13/1,2344/SKD61	51+	0,26	0,31	0,42	0,52	0,65	60 - 75%	HF	HSN	96 - 157	0,16~0,36	0,21~0,41	0,32~0,52	0,42~0,62	0,55~0,75
A2/1,2363/SKD12	<41	0,38	0,46	0,61	0,76	0,95	60 - 75%	HF	XRN/HSN	157 - 218	0,28~0,48	0,36~0,56	0,51~0,71	0,66~0,86	0,85~1,05
A2/1,2363/SKD12	14-50	0,32	0,38	0,51	0,64	0,80	60 - 75%	HF	XRN/HSN	126 - 187	0,220~0,42	0,28~0,48	0,32~0,52	0,54~0,74	0,70~0,90
A2/1,2363/SKD12	51+	0,26	0,31	0,42	0,52	0,65	60 - 75%	HF	HSN	96 - 157	0,16~0,36	0,21~0,41	0,51~0,71	0,42~0,62	0,55~0,75
P20/1,2330	<41	0,38	0,46	0,61	0,76	0,95	60 - 75%	HF	XRN/HSN	157 - 218	0,28~0,48	0,36~0,56	0,41~0,61	0,66~0,86	0,85~1,05
P20/1,2330	14-50	0,32	0,38	0,51	0,64	0,80	60 - 75%	HF	XRN/HSN	126 - 187	0,22~0,42	0,28~0,48	0,51~0,71	0,54~0,74	0,70~0,90
D2/1,2379/SKD11	<41	0,38	0,46	0,61	0,76	0,95	60 - 75%	HF	XRN/HSN	157 - 218	0,28~0,48	0,36~0,56	0,41~0,71	0,66~0,86	0,85~1,05
D2/1,2379/SKD11	14-50	0,32	0,38	0,51	0,64	0,80	60 - 75%	HF	XRN/HSN	126 - 187	0,22~0,42	0,28~0,48	0,41~0,61	0,54~0,744	0,70~0,90
D2/1,2379/SKD11	51+	0,26	0,31	0,42	0,52	0,65	60 - 75%	HF	HSN	96 - 157	0,16~0,36	0,21~0,41	0,32~0,52	0,42~0,62	0,55~0,75
Grey Cast Iron/GG	<41	0,38	0,46	0,61	0,76	0,95	60 - 75%	HF	XRN/HSN	157 - 218	0,282~0,48	0,36~0,56	0,51~0,71	0,66~0,86	0,85~1,05
Cast Iron/GGG	41+	0,38	0,46	0,61	0,76	0,95	60 - 75%	HF	XRN/HSN	157 - 218	0,28~0,48	0,36~0,56	0,51~0,71	0,66~0,86	0,85~1,05

Copy Milling Inserts

NA

Non-coated grade.

XRN

Multi-layer hybrid coating of AlCrN. This coating has very good heat resistance and also a low friction coefficient. The XRN coating is designed for use in HSM of un-heat treated softer materials such as Titanium, Inconel, Stainless Steels and other gummy materials that require the use of liquid coolant.

HSN

Millstar's new coating is a multi-layer hybrid Nano coating. This new coating has very good heat resistance and high hardness. The HSN coating is designed for use in HSM of Heat Treated materials up to 72 HRC.

ALTiN-EXALON (TLN)

Titanium Aluminum Nitride advanced PVD coating. A special, improved ALTiN coating approaching surface hardness of CBN on a tough substrate. Recommended for tough and hard metal machining applications.

DMD

Diamond coating. Custom coating for cutting non-ferrous, non-metallic and very abrasive materials at highly elevated speeds. Use on copper, bronze, brass, aluminum-silicon alloys, carbon graphite, solid and fiber-reinforced plastics, ceramics and composite materials.

Custom tool coatings for specific applications are available by request.

Flat Bottom, Back Draft, Toroid

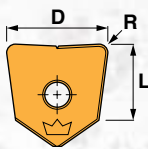
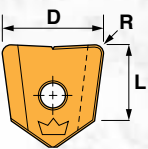
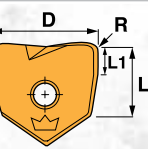
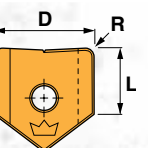
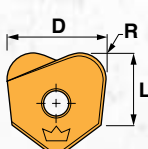
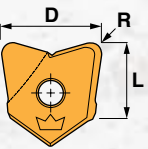
BD-N	Tool Ordering Number	Dimensions			Grade			Description	
		D	L	R	XRN	TLN	HSN		
	BD-10-N	10	8,5	0,5/0,8/1,0	•	•	•	Precision ground with 7° back taper. Used for milling of cores, cavities, fillets with straight or very steep walls of harder materials.	
	BD-12-N	12	9,95	0,5/1,0/2,0	•	•	•		
	BD-16-N	16	11,55	0,5/1,0/1,3/2,0/3,0	•	•	•		
	BD-20-N	20	13,35	0,5/1,0/1,6/2,0/3,0	•	•	•		
	BD-25-N	25	19,95	1,0/2,0	•	•	•		
	BD-32-N	32	8,5	1,0/2,6	•	•	•		
BD-R	Number	D	L	R	XRN	TLN	HSN	Description	
	BD-10-R	10	8,5	0,5/0,8/1,0	•	•	•	Precision ground with positive ground chip-breaker and 7° back taper. Used for milling of cores, cavities, fillets with straight or very steep walls of softer materials.	
	BD-12-R	12	9,95	0,5/1,0	•	•	•		
	BD-16-R	16	11,55	0,5/1,0/1,3	•	•	•		
	BD-20-R	20	13,35	0,5/1,0/1,6	•	•	•		
	BD-25-R	25	19,95	1,0/2,0	•	•	•		
	BD-32-R	32	23,35	2,6	•	•	•		
BDS	Number	D	L	R	L1	XRN	TLN	HSN	Description
	BDS-10-N	10	8,5	0,1/0,8/1,0	3	•	•	•	Precision ground with unique crossover design between flat bottom FB and back draft DB inserts. Allows straight walls with a larger step down than BD. Allows higher cutting speeds and feeds.
	BDS-12-N	12	9,95	0,1/1,0	3	•	•	•	
	BDS-16-N	16	11,55	0,1/1,0/1,3	3	•	•	•	
	BDS-20-N	20	13,35	0,1/1,0/1,6	3	•	•	•	
	BDS-25-N	25	19,95	1,0/2,0	3	•	•	•	
	BDS-32-N	32	23,35	1,0/2,0	3	•	•	•	
FB-R	Number	D	L	R	XRN	TLN	HSN	Description	
	FB-10-R	10	8,5	0,8	•	•	•	Precision ground with positive ground chip-breaker. Flat bottom inserts for shoulder milling, fillet finishing and long reach angular wall finishing of softer materials.	
	FB-12-R	12	9,15	1,0	•	•	•		
	FB-16-R	16	10,65	0,5/1,3	•	•	•		
	FB-20-R	20	12,25	1,6	•	•	•		
	FB-25-R	25	16,35	2,0	•	•	•		
	FB-32-R	32	21,3	2,6	•	•	•		
TO	Number	D	L	R	XRN	TLN	HSN	Description	
	TO-10	10	8,65	3,0	•	•	•	Precision ground large corner radius & back taper for spiral and pocket milling. Milling of pre-hard and hardened flat surfaces at higher speeds than tools with smaller corner radii. Good choice for HS milling of Aluminum.	
	TO-12	12	9,20	3,0	•	•	•		
	TO-16	16	11,25	4,0	•	•	•		
	TO-20	20	13,15	5,0	•	•	•		
	TO-25	25	18,25	6,0	•	•	•		
	TO-30	30	22,15	7,5	•	•	•		
	TO-32	32	21,95	8,0	•	•	•		
TOBD-NF	Number	D	L	R	XRN	TLN	HSN	Description	
	TOBD-12-NF	12	9,2	3,0	•	•	•	Millstar inserts designed for high speed high feed roughing of Aluminum, but also has the versatility to be used for fine finishing as well.	
	TOBD-16-NF	16	11,25	3,0	•	•	•		
	TOBD-20-NF	20	13,15	3,0	•	•	•		
	TOBD-25-NF	25	18,25	3,0	•	•	•		

BDS Series in PCD and CBN Tipped

Back Draft

BDS	Tool Ordering Number	Dimensions				Grade			Description
		D	L	R	L1	XRN	TLN	HSN	
	BDS-10-N	10	8,5	0,1/0,8/1,0	3	•	•	•	Precision ground with unique crossover design between flat bottom FB and back draft BD inserts. Allows straight walls with a larger step down than BD. Allows higher cutting speeds and feeds.
	BDS-12-N	12	9,95	0,1/1	3	•	•	•	
	BDS-16-N	16	11,55	0,1/1/1,3	3	•	•	•	
	BDS-20-N	20	13,35	0,1/1/1,6	3	•	•	•	
	BDS-25-N	25	19,95	1/2	3	•	•	•	

PCD Tipped

For carbon milling with longer tool life

CBN Tipped

For high speed machining or milling of high hardness materials with longer tool life and superior finishes.

NEW!

Higher cutting speeds and feeds with new Back Draft Tools

Radius Ordering Numbers:

For .015 use ordering # .015 • For 1/32" use ordering # 02 1/16" use ordering # 04
For 1/8" use ordering # 08

Example: 1/2" BDS-0500N-04-PCD or CBN

Copy Milling Inserts

Ball Nose Inserts

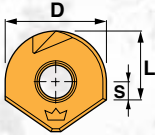
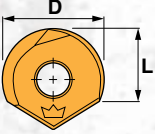
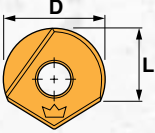
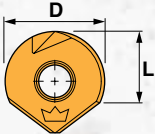
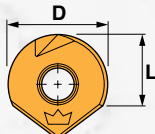
BS-N	Tool Ordering Number	Dimensions			Grade			Description
		D	L	S	XRN	TLN	HSN	
	BS-10-N	10	9,50	3,65	•	•	•	Sidecutting, non-chipbreaker. Side cutting insert used in cavity and core profiling, for blending of fillets on medium and hard materials.
	BS-12-N	12	8,80	2,90	•	•	•	
	BS-16-N	16	10,70	2,85	•	•	•	
	BS-20-N	20	12,75	2,85	•	•	•	
	BS-25-N	25	17,20	4,85	•	•	•	
	BS-30-N	30	20,00	5,10	•	•	•	
	BS-32-N	32	21,00	5,30	•	•	•	
MB	Number	D	L	XRN	TLN	HSN	Description	
	MB-10	10	8,65	•	•	•	Unique cutting edge allows performance in all operations in material below 42 HRC; in semi- & finishing operations above. Significant benefits in chip evacuation. Insert geometry allows smoother cutting motion-diminishing heat build up & tool deflection, reduces vibration caused by cutting action.	
	MB-12	12	9,20	•	•	•		
	MB-16	16	11,25	•	•	•		
	MB-20	20	13,15	•	•	•		
	MB-25	25	18,25	•	•	•		
	MB-30	30	22,15	•	•	•		
	MB-32	32	21,95	•	•	•		
MBT	Number	D	L	XRN	TLN	HSN	Description	
	MBT-10	10	8,65	•	•	•	Precision ground, harder grade, for semi-finish and finish milling. Excellent choice for unattended finish milling at small depth and high speeds and feed rates.	
	MBT-12	12	9,20	•	•	•		
	MBT-16	16	11,25	•	•	•		
	MBT-20	20	13,15	•	•	•		
	MBT-25	25	18,25	•	•	•		
	MBT-30	30	22,15	•	•	•		
	MBT-32	32	21,95	•	•	•		
RB-N	Number	D	L	XRN	TLN	HSN	Description	
	RB-10-N	10	9,50	•	•	•	Precision ground, non-chipbreaker. Best choice for cavity, core and profile milling of pre-hard and fully hard die/mold steels, cast steels and cast iron. Strongest cutting edge design.	
	RB-12-N	12	9,20	•	•	•		
	RB-14-N	14	9,45	•	•	•		
	RB-16-N	16	11,25	•	•	•		
	RB-20-N	20	13,15	•	•	•		
	RB-22-N	22	17,45	•	•	•		
	RB-25-N	25	18,25	•	•	•		
	RB-30-N	30	22,15	•	•	•		
	RB-32-N	32	21,95	•	•	•		
	RBT	Number	D	L	XRN	TLN		HSN
	RB-10-T	10	8,65			•	Precision ground for semi-finish and finish milling. Excellent choice for unattended finish milling at small depth and high speed and feed rates.	
	RB-12-T	12	9,20			•		
	RB-16-T	16	11,25			•		
	RB-20-T	20	13,15			•		
	RB-25-T	25	18,25			•		
	RB-30-T	30	22,15			•		
	RB-32-T	32	21,95			•		

NA

Non-coated grade.

XRN

Multi-layer hybrid coating of AlCrN. This coating has very good heat resistance and also a low friction coefficient. The XRN coating is designed for use in HSM of un-heat treated softer materials such as Titanium, Inconel, Stainless Steels and other gummy materials that require the use of liquid coolant.

HSN

Millstar's new coating is a multi-layer hybrid Nano coating. This new coating has very good heat resistance and high hardness. The HSN coating is designed for use in HSM of Heat Treated materials up to 72 HRC.

ALTiN-EXALON (TLN)

Titanium Aluminum Nitride advanced PVD coating. A special, improved ALTiN coating approaching surface hardness of CBN on a tough substrate. Recommended for tough and hard metal machining applications.

DMD

Diamond coating. Custom coating for cutting non-ferrous, non-metallic and very abrasive materials at highly elevated speeds. Use on copper, bronze, brass, aluminum-silicon alloys, carbon graphite, solid and fiber-reinforced plastics, ceramics and composite materials.

Custom tool coatings for specific applications are available by request.

Choosing Cutting Parameters/Calculating Cutting Speed and Feed – METRIC For Ball Nose Inserts

Table 1 - Cutting Conditions for Using Steel Shank Holders

Working Material	Hardness	Grade	Vc m/min	Feed fn (mm/Rev)										Ap Max	Ae Max
				Insert Diameter (mm)											
				6	8	10	12	16	20	25	30	32			
Low Alloy Steel (1.7225)	200-280HB	TLN, HSN	150-200	0,2	0,3	0,4	0,4	0,5	0,5	0,6	0,6	0,6	.15 x D	.15 x D	
Alloy & Die Steel (1.2311, P20, DME2/3/5)	32-42HRC	TLN, HSN	100-150	0,15	0,25	0,3	0,4	0,4	0,4	0,5	0,5	0,5	.20 x D	.20 x D	
Tool Steel (1.2344, 1.2379)	42-52HRC	TLN, HSN	120-160	0,15	0,25	0,3	0,4	0,5	0,5	0,6	0,6	0,6	.20 x D	.20 x D	
Stainless Steel (1.4301, 1.4401)	200-350HB	XRN, TLN, HSN	90-120	0,15	0,25	0,3	0,4	0,4	0,4	0,5	0,5	0,5	.20 x D	.20 x D	
Gray Cast Iron (GG25-GG30)	160-260HB	TLN, HSN	200-360	0,2	0,3	0,4	0,5	0,6	0,6	0,7	0,7	0,7	.10 x D	.10 x D	
Nodular Cast Iron (GGG60-GGG70)	180-300HB	TLN, HSN, HSN	150-300	0,2	0,3	0,4	0,5	0,6	0,6	0,7	0,7	0,7	.15 x D	.15 x D	
Copper Alloy	80-150HB	XRN	150-200	0,25	0,4	0,5	0,6	0,7	0,7	0,8	0,8	0,8	.10 x D	.10 x D	
Aluminum Alloys	30-120HB	XRN	200-300	0,25	0,4	0,5	0,6	0,7	0,7	0,8	0,8	0,8	.6 x D	.6 x D	
Graphite		TLN	200-400	0,3	0,5	0,6	0,7	0,8	0,8	0,9	0,9	0,9	.5 x D	.5 x D	
Ni & Co Based Alloy	250-320HB	XRN, HSN	30-70	0,15	0,2	0,3	0,4	0,4	0,5	0,5	0,6	0,6	.30 x D	.30 x D	
Titanium Alloy (Annealed)	<350HB	XRN, HSN	50-120	0,15	0,2	0,25	0,35	0,35	0,4	0,45	0,5	0,5	.33 x D	.33 x D	
Titanium Alloy (Sol. Treated/Aged)	<380HB	XRN, HSN	40-90	0,1	0,15	0,2	0,3	0,3	0,35	0,4	0,45	0,45	.35 x D	.35 x D	
Harden Steel (1.2344, 1.2379)	45-55HRC	TLN, HSN	70-90	0,15	0,25	0,3	0,4	0,5	0,5	0,6	0,6	0,6	.30 x D	.30 x D	

Table 2 - Cutting Conditions for Using Carbide Shank Holders

Working Material	Hardness	Grade	Vc m/min	Feed fn (mm/Rev)										Ap Max	Ae Max
				Insert Diameter (mm)											
				6	8	10	12	16	20	25	30	32			
Low Alloy Steel (1.7225)	200-280HB	TLN, HSN	260-380	0,3	0,4	0,4	0,5	0,6	0,6	0,7	0,7	0,7	.15 x D	.50 x D	
Alloy & Die Steel (1.2311, P20, DME2/3/5)	32-42HRC	TLN, HSN	250-330	0,25	0,3	0,3	0,4	0,5	0,5	0,6	0,6	0,6	.20 x D	.50 x D	
Tool Steel (1.2344, 1.2379)	42-52HRC	TLN, HSN	240-320	0,25	0,3	0,3	0,4	0,5	0,5	0,6	0,6	0,6	.20 x D	.50 x D	
Stainless Steel (1.4301, 1.4401)	200-350HB	XRN, TLN, HSN	200-260	0,25	0,3	0,4	0,5	0,6	0,65	0,7	0,8	0,8	.20 x D	.50 x D	
Gray Cast Iron (GG25-GG30)	160-260HB	TLN, HSN	360-450	0,35	0,45	0,5	0,5	0,6	0,7	0,8	1,0	1,0	.10 x D	.40 x D	
Nodular Cast Iron (GGG60-GGG70)	180-300HB	TLN, HSN	300-400	0,3	0,4	0,4	0,5	0,6	0,6	0,7	0,8	0,8	.15 x D	.15 x D	
Copper Alloy	80-150HB	XRN	300-400	0,3	0,4	0,4	0,5	0,6	0,6	0,7	0,7	0,7	.10 x D	.40 x D	
Aluminum Alloys	30-120HB	XRN	400-500	0,3	0,4	0,5	0,6	0,7	0,7	0,8	0,8	0,8	.6 x D	.40 x D	
Graphite		TLN, HSN	600-800	0,3	0,5	0,6	0,7	0,8	0,8	0,9	0,9	0,9	.5 x D	.40 x D	
Ni & Co Based Alloy	250-320HB	XRN, HSN	80-110	0,25	0,3	0,4	0,4	0,5	0,6	0,6	0,7	0,7	.30 x D	.50 x D	
Titanium Alloy (Annealed)	<350HB	XRN, HSN	150-230	0,15	0,2	0,25	0,35	0,35	0,4	0,45	0,5	0,5	.33 x D	.50 x D	
Titanium Alloy (Sol. Treated/Aged)	<380HB	XRN, HSN	110-220	0,1	0,15	0,2	0,3	0,3	0,35	0,4	0,45	0,45	.35 x D	.50 x D	
Harden Steel (1.2344, 1.2379)	45-55HRC	TLN, HSN	120-220	0,2	0,25	0,3	0,4	0,5	0,5	0,6	0,6	0,6	.30 x D	.30 x D	

Choosing Cutting Parameters/Calculating Cutting Speed and Feed – METRIC

1. Find the Cutting Speed V_c (m/min) & Feed f_n (mm/r¹)

Find V_c and f_n range in Table 1 or Table 2 above. Choose the average value for V_c and the lower value for feed in the range.

2. Compute the D_w

In order to compute the RPM value of the spindle it is necessary to determine the D_w which is the effective engaged tool diameter. The D_w depends on the geometry of the inserts (ball nose or toroid) and the relative position of the tool against the working piece surface.

Example calculation is of D_w is presented to the right.

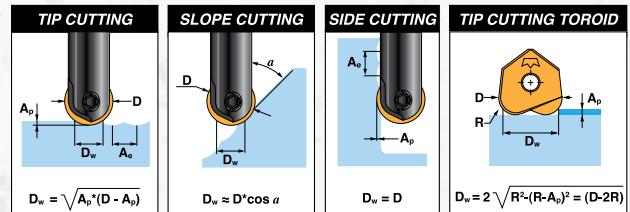

3. Calculate Spindle Speed N (n/min)

Use the formula: $N = (V_c \cdot 1,000) / \pi \cdot D_w$

Table 3 - Working Diameter For Ball Nose Tools (tip cutting)

ØD	A _p																		
	0,1	0,2	0,3	0,4	0,5	0,6	0,7	0,8	0,9	1	1,5	2	2,5	3	3,5	4	5	6	7
6	1,5	2,2	2,6	3	3,3	3,6	3,9	4,1	4,3	4,5	5,2	5,7	5,9	6,0					
8	1,8	2,5	3	3,5	3,9	4,2	4,5	4,8	5,1	5,3	6,2	6,9	7,4	7,7					
10	2	2,8	3,4	3,9	4,4	4,7	5,1	5,4	5,7	6,0	7,1	8,0	8,7	9,2	9,5				
12	2,2	3,1	3,7	4,3	4,8	5,2	5,6	6,0	6,3	6,6	7,9	8,9	9,7	10,4	10,9	11,3	11,8		
14	2,4	3,3	4,1	4,7	5,2	5,7	6,1	6,5	6,9	7,2	8,7	9,8	10,7	11,5	12,1	12,6	13,4	13,9	
16	2,5	3,6	4,3	5	5,6	6,1	6,5	7,0	7,4	7,7	9,3	10,6	11,6	12,5	13,2	13,9	14,8	15,5	15,9
20	2,8	4	4,9	5,6	6,2	6,8	7,4	7,8	8,3	8,7	10,5	12,0	13,2	14,3	15,2	16,0	17,3	18,3	19,1
25		4,5	5,4	6,3	7,0	7,7	8,2	8,8	9,3	9,8	11,9	13,6	15,0	16,2	17,3	18,3	20,0	21,4	22,4
30			6	6,9	7,7	8,4	9,1	9,7	10,2	10,8	13,1	15,0	16,6	18,0	19,3	20,4	22,4	24,0	25,4
32				7,1	7,9	8,7	9,4	10,0	10,6	11,1	13,5	15,5	17,2	18,7	20	21,2	23,2	25,0	26,5

Table 4 - Working Diameter For Toroid Tools (tip cutting)

Insert Diameter "D"	10	12	16	20	25	30	32
Depth of Cut	D _w Working Diameter (metric) Actual cutting diameter of toroid inserts						
0,5	7,3	9,3	11,9	14,3	17,8	20,4	21,6
1,0	8,5	10,5	13,3	16,0	19,6	22,5	23,8
2,0	9,7	11,7	14,9	18,0	22,0	25,2	26,6
3,0	10,0	12,0	15,8	19,2	23,4	27,0	28,5
4,0			16,0	19,8	24,3	28,3	29,9
5,0				20,0	24,9	29,2	30,8
6,0					25,0	29,7	31,5
8,0						30,0	32,0

4. Calculate the Table Feed V_f (m/min)

Use the formula: $V_f = N \cdot f_n \cdot K_f$. K_f is the feed rate multiplier coefficient taking into consideration that chip load is less than theoretical value. Take the value of K_f from Table 5 or Table 6.

Table 5 - Feed Rate Multiplier For Ball Nose Inserts

Insert Diameter "D"	6	8	10	12	16	20	25	30	32
Depth of Cut	Feedrate Multiplier Factors (for working diameters D _w)								
0,5	1,8	2,0	2,2	2,5	2,8	3,2	3,5	3,8	4,0
1,0	1,2	1,5	1,6	1,8	2,0	2,2	2,5	2,6	2,8
2,0	1,0	1,1	1,2	1,3	1,5	1,6	1,8	1,9	2,0
3,0	0,0	1,0	1,1	1,1	1,2	1,4	1,5	1,6	1,7
4,0		1,0	1,0	1,1	1,2	1,2	1,3	1,4	1,5
5,0			1,0	1,0	1,1	1,1	1,2	1,3	1,4
6,0				1,0	1,0	1,1	1,2	1,2	1,3
8,0					1,0	1,0	1,1	1,1	1,2
10,0						1,0	1,0	1,1	1,1
12,5							1,0	1,0	1,0
16,0								1,0	1,0

Table 6 - Feed Rate Multiplier For Toroid Tools

Insert Diameter "D"	10	12	16	20	25	30	32
Depth of Cut	Feedrate Multiplier Factors (for Toroid working diameters D _w)						
0,5	1,8	1,8	2,0	2,2	2,5	2,6	2,8
1,0	1,2	1,2	1,5	1,6	1,8	1,9	2,0
2,0	1,0	1,0	1,1	1,2	1,3	1,4	1,5
3,0	1,0	1,0	1,0	1,1	1,1	1,2	1,2
4,0			1,0	1,0	1,1	1,2	1,2
5,0				1,0	1,0	1,1	1,1
6,0					1,0	1,0	1,0
8,0						1,0	1,0

Verify Surface Roughness (R_{th})

1. Decreasing the A_e and feed by half will improve surface roughness by 4 times.
2. Using $f_z = A_e$ in most cases is the best option.

Surface Roughness Step-Over

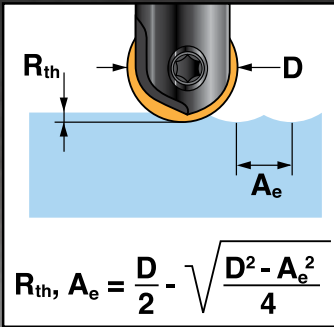

Surface Roughness Feed Dir

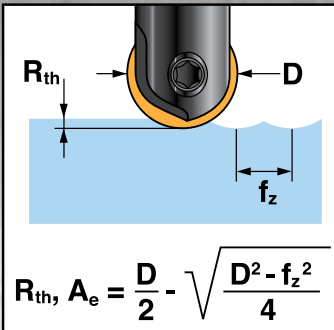

$f_z > A_e$

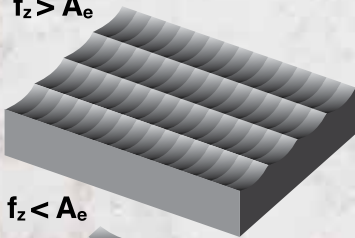

$f_z < A_e$

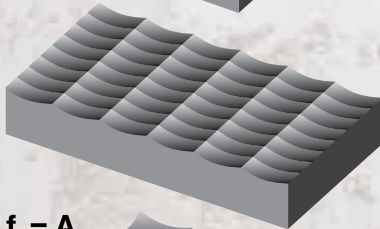

$f_z = A_e$

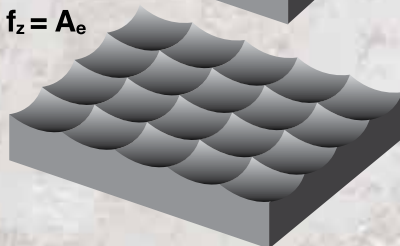

Normal Cutting Parameter Recommendations for BDS, BD and FB inserts For typical mold steels (1.2311, 1.2344, 1.2711, 1.2714, etc.)

The following parameters are ONLY if cutting a flat surface with the bottom of the tool. For finish machining using only the side of the tool, use the cutting parameters for Ball Inserts.

1. Spindle speed: $n(s)$ (min^{-1})								
FB or BD $\varnothing \Rightarrow$	6	8	10	12	16	20	25	32
Material hardness	Spindle speed $n(s)$							
< 40 HRc	8000	5600	4600	3600	2800	2250	1800	1500
40-54 HRc	7000	4900	3850	2800	2400	1960	1540	1350
55-64 HRc	6000	4200	3100	2200	1800	1500	1350	1200
2. Feed per tooth: f_z (mm/tooth)								
FB or BD $\varnothing \Rightarrow$	6	8	10	12	16	20	25	32
Material hardness	Feed per tooth f_z							
< 40 HRc	0.15	0.15	0.2	0.25	0.3	0.35	0.35	0.4
40-54 HRc	0.15	0.15	0.2	0.25	0.3	0.35	0.35	0.4
55-64 HRc	0.1	0.12	0.15	0.20	0.25	0.25	0.25	.25
3. Cutting depth: a_p (mm)								
FB or BD $\varnothing \Rightarrow$	6	8	10	12	16	20	25	32
Material hardness	Maximum Cutting depth a_p							
< 40 HRc	0.3	0.35	0.5	0.6	0.8	1.0	1.25	1.6
40-54 HRc	0.2	0.25	0.5	0.6	0.8	1.0	1.25	1.6
55-64 HRc	0.1	0.12	0.4	0.45	0.65	0.8	1.0	1.25
4. Maximum Cutting width / step-over: a_e (mm)								
FB or BD $\varnothing \Rightarrow$	6	8	10	12	16	20	25	32
Material hardness	Cutting width a_e							
< 40 HRc	4	6	8	9	13	17	20	26
40-54 HRc	4	6	8	9	13	17	20	26
55-64 HRc	4	6	8	9	13	17	20	26

Additional recommendations and conditions which make it necessary to modify normal cutting parameters

- Always use climb cutting in roughing operation.
- Enter the material with the cutter by straight ramping or helical interpolation ramping. A 2° ramp angle will achieve best results.
- When roughing a cavity level by level (Z-level) it is best to start in the center and work outward in a square, rectangular or round spiral depending on the shape of the work piece. Use climb cutting.
- Long tool body extension from the spindle or tool adapter will make it necessary to decrease the recommended parameters above:
 - If the tool body extension is 3 times the ball insert diameter or less, use the recommendations on page 1.
 - If the tool body extension is 4 times the ball insert diameter, multiply the cutting parameters by 0.9 (90 %).
 - If the tool body extension is 5 times the ball insert diameter, multiply the cutting parameters by 0.75 (75 %). Use a tapered tool body for additional strength.
 - If the tool body extension is 6 times the ball insert diameter, multiply the cutting parameters by 0.6 (60 %). Use a tapered tool body for additional strength.
 - If the tool extension is greater than 6 times the ball insert diameter, it is recommended to use a carbide tool body instead of a steel body for additional rigidity.
- If the spindle speed recommended is higher than the spindle speed available on the machine, use the highest spindle speed available. You may use the same recommended feed per tooth, cutting depth and cutting width as shown above. We do not recommend reducing the feed per tooth.

Copy Milling Program Tools







Millstar face mills are equally useful on newer high velocity machines and older slower equipment and will optimize milling performance of all your machine tools. The hardened tool bodies can be run at aggressive spindle speed and feed rates, when used with Millstar's precision ground, strong and thick, round inserts with proven hard, high performance TLN and HSN tool coatings.

The tools provide for precision finish results, minimal tool deflection and run-out. Excellent milling results can be achieved in roughing, semi finishing and fine finishing in Z-level, profiling or raster cuts, as well as in linear or circular interpolation milling or ramping.

The tools may be used with coolant, but we recommend dry, mist or MQL (minimum quantity lubrication) milling with strong air blast when high speed or hard machining steel, particularly in the higher hardness range (> 45HRc / 425 HBN).

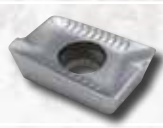

Copy Milling Program Tool Contents

FM Style 1	Toroid Cylindrical End Milling Cutter	80	
FM Style 2	Toroid Taper End Milling Cutter	80	
FMA	Arbor Style Milling Cutter	80	
Insert Data		81	
Cutting Parameters		81	
APKT Series		82	
Arbor Style Holders		83	
Screw On Heads		83	

Milling Cutters Identification System

Arbor

Measurement System	Denotes Copy Milling Arbor Style	Denotes Diameter Size		Denotes Number of Flutes
Imperial	FMA	2000	/	5
Metric	FMA	63	/	5

Shank

Measurement System	Denotes Copy Milling Cutter	Denotes Diameter Size		Denotes Number of Flutes		Denotes Tool Cutter Length		Denotes Tool Diameter Shank
Imperial	FM	1000	/	2	-	6.0	-	1000
Metric	FM	25	/	2	-	180	-	25

Copy Milling Program Tools

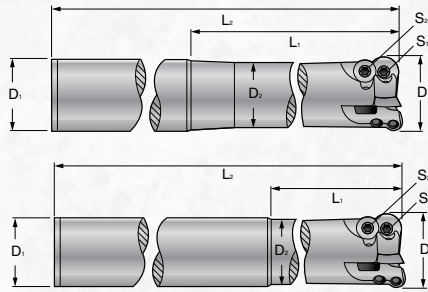

Toroid Taper End Milling Cutters Toroid Cylindrical End Milling Cutters

Tool Ordering Number	Dimensions						Insert Screw	Face Clamp Screw	Key	Insert Code
	ØD	ØD1	ØD2	L1	L2	Z				
FM-25/2-180-25	25	25	23	30	180	2	FMIS-1	FMIS-2	T15	FMI-12T3
FM-32/2-180-32-16	32	32	29	100	180	2	FMIS-6	FMIS-6 FMIW-6	T20	FMI-1604
FM-32/3-180-25	32	25	24	42	180	3	FMIS-1	FMIS-2	T15	FMI-12T3 FMIR-12T3
FM-32/3-180-32	32	32	29	70	180	3	FMIS-1	FMIS-2	T15	FMI-12T3 FMIR-12T3
FM-32/4-180-32-10	32	32	31	42	180	4	FMIS-1	NA	T15	FMI-1003
FM-40/3-180-32-16	40	32	29	NA	180	3	FMIS-6	FMIS-6 FMIW-6	T20	FMI-1604
FM-40/4-180-32	40	32	31	42	180	4	FMIS-1	FMIS-2	T15	FMI-12T3 FMIR-12T3
FM-42/4-180-32	42	32	31	42	180	4	FMIS-1	FMIS-2	T15	FMI-12T3 FMIR-12T3

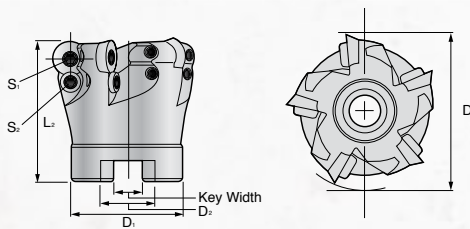

Arbor Style Milling Cutters

Tool Ordering Number	Dimensions						Arbor Screw	Insert Screw S1	Face Clamp Screw S2	Key	Insert Code
	ØD	ØD1	L2	Z	Key Width	D2					
FMA-50/5	50	40	50	5	10,4	22	10mm	FMIS-1	FMIS-2	T15	FMI-12T3 FMIR-12T3
FMA-52/7-10	52	40	50	7	10,4	22	10mm	FMIS-1	NA	T15	FMI-1003
FMA-52/5	52	40	50	5	10,4	22	10mm	FMIS-1	FMIS-2	T15	FMI-12T3 FMIR-12T3
FMA-52/4-16	52	40	50	4	10,4	22	10mm	FMIS-6	FMIS-6 FMIW-6	T20	FMI-1604
FMA-63/5	63	42	50	5	10,4	22	12mm	FMIS-1	FMIS-2	T15	FMI-12T3 FMIR-12T3
FMA-63/5-16	63	48	50	5	12,4	27	12mm	FMIS-6	FMIS-6 FMIW-6	T20	FMI-1604
FMA-63/5-16-22	63	40	50	5	10,4	22	12mm	FMIS-6	FMIS-2	T15	FMI-1604
FMA-100/7-16	100	84	55	7	14,4	32	32mm	FMIS-6	FMIS-6 FMIW-6	T20	FMI-1604

Copy Milling Program Tools

Working Diameter (D_w)

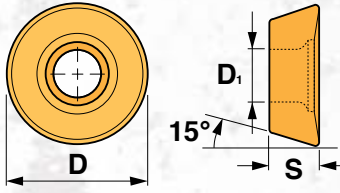

Insert Data

Tool Ordering Number	Dimensions			HSN	TLN
	D	S	D1		
FMI-0702	7	2,38	2,84	•	•
FMI-1003	10	3,18	3,88	•	•
FMI-12T3	12	3,97	3,9	•	•
FMIR-12T3	12	3,97	3,9	•	•
FMI-1604	16	4,77	5,2	•	•

Cutting Conditions: Recommended Cutting Speed And A_p

Working Material	Hardness	Insert Type	Grade	Vc m/min	A_p Max Roughing	A_p Max Medium	A_p Max Light
Low Alloy Steel (1.7225)	200-280HB	FMI	HSN, TLN	130-200	2,5-4,5	1,0-2,5	0,1-1,0
Alloy & Die Steel (1.2311, P20, DME2/3/5)	32-42HRC	FMI	HSN, TLN	100-150	2,5-4,0	1,0-2,5	0,1-1,0
Tool Steel (1.2344, 1.2379)	42-52HRC	FMI	HSN, TLN	80-100	2,0-3,5	1,0-2,5	0,1-1,0
Stainless Steel (1.4301, 1.4401)	200-350HB	FMIR	HSN, TLN	120-170	2,5-4,0	1,0-2,5	0,1-1,0
Gray Cast Iron (GG25-GG30)	160-260HB	FMIR	HSN, TLN	140-190	2,5-4,0	1,0-2,5	0,1-1,0
Nodular Cast Iron (GGG60-GGG70)	180-300HB	FMIR	HSN, TLN	120-170	2,5-4,0	1,0-2,5	0,1-1,0
Copper Alloy	80-150HB	FMIR	TLN	350	2,5-4,5	1,0-2,5	0,1-1,0
Aluminum Alloys	30-120HB	FMIR	TLN	400	2,5-5,0	1,0-2,5	0,1-1,0
Ni & Co Based Alloy	250-320HB	FMIR	HSN, TLN	30-60	2,0-3,0	1,0-2,5	0,1-1,0
Titanium Alloy (Annealed)	<350HB	FMIR	HSN, TLN	50-70	2,0-3,0	1,0-2,5	0,1-1,0

Cutting Conditions: Recommended Feed f_z (mm/tooth)

Operation	A_p												
	IC	0,3	0,5	0,7	0,8	1	1,2	2	3	4	5	6	8
Light	10	0,3	0,23	0,2	0,18	0,15	0	0	0	0	0	0	0
	12	0,38	0,3	0,25	0,23	0,21	0,18	0	0	0	0	0	0
	16	0,45	0,35	0,3	0,27	0,23	0,21	0,18	0	0	0	0	0
Rough	10	0	0	0	0	0,32	0,29	0,22	0,18	0,16	0,14	0	0
	12	0	0	0	0	0,42	0,38	0,3	0,28	0,24	0,20	0,18	0,16
	16	0	0	0	0	0,50	0,47	0,36	0,3	0,27	0,25	0,34	0,23

In order to compute the RPM value of the spindle it is necessary to determine the D_w which is the effective engaged tool diameter. The D_w depends on the geometry of the inserts (ball nose or toroid) and of the relative position of the tool against the working piece surface. A formula is presented.

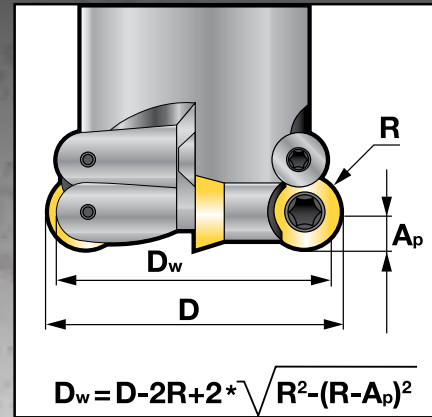

The "fz" indicated above is for an overhang of 3xD. The values are calculated based on the recommended thickness of the chip "hm".

LIGHT: Ae up to 25% of the Diameter of the Tool "D".

ROUGH: Ae up to 75% of the Diameter of the Tool "D".

APKT Series, Inserts and Bodies

Inserts

Millstar Insert Number	Corner Radius	Use
APHT-1003-AL	0.8	Aluminum
APHT-1604-AL	0.8	Aluminum
APKT-1003-TLN or HSN	0.4	Steel
APKT-1003-TCT	0.4	Steel
APKT-1604-TCT	0.8	Steel
APKT-1604-TLN or HSN	0.8	Steel
APMT-1604-12-TLN	1.2	Steel
APMT-1604-16-TLN	1.6	Steel
APMT-1604-24-TLN	2.4	Steel
APMT-1604-32-TLN	3.2	Steel
APMT-1604-40-TLN	4	Steel
APMT-1604-48-TLN	4.8	Steel
APMT-1604-64-TLN	6.4	Steel

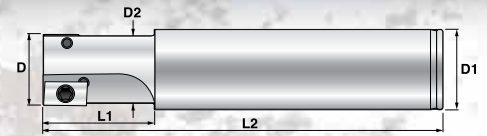
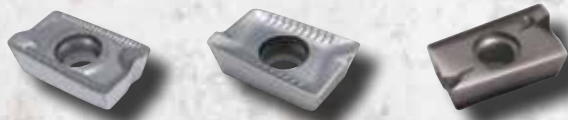

DSKI Bodies for 1003 Insert

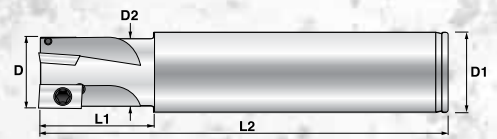

DSMI Bodies for 1604 Insert

Bodies for 1003 Insert

Millstar Part Number	Diameter (D)	Shank Diameter (D1)	Overall Length (L2)	Effective Length (L1)	No. of Flutes	Insert size	Screw	Torx
DSKI-10-110-16	10	16	110	25	1	1003	1425	T07
DSKI-12-110-16	12	16	110	25	1	1003	1425	T07
DSKI-16-110-20	16	20	110	25	2	1003	1425	T07
DSKI-16-175-20	16	20	175	25	2	1003	1425	T07
DSKI-20-125-20	20	20	125	30	3	1003	1225	T07
DSKI-20-200-20	20	20	200	30	3	1003	1225	T07
DSKI-25-125-25	25	25	125	30	4	1003	1225	T07

Bodies for 1604 Insert

Millstar Part Number	Diameter (D)	Shank Diameter (D1)	Overall Length (L2)	Effective Length (L1)	No. of Flutes	Insert size	Screw	Torx
DSMI-20-100-20	20	20	100	30	1	1604	1440	T15
DSMI-20-200-20	20	20	200	35	1	1604	1440	T15
DSMI-25-100-25	25	25	100	30	2	1604	1440	T15
DSMI-25-200-25	25	25	200	35	2	1604	1440	T15
DSMI-32-110-32	32	32	110	35	3	1604	1240	T15
DSMI-32-250-32	32	32	250	35	3	1604	1240	T15
DSMI-40-110-32	40	32	110	35	4	1604	1240	T15
DSMI-40-250-32	40	32	250	35	4	1604	1240	T15

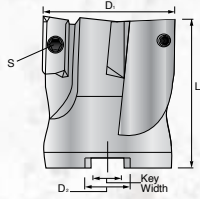

Arbor Style Holders for 1003 Insert

Millstar Part Number	Diameter (D1)	Height (L1)	Keyway	Bore (D2)	No. of Flutes	Insert size	Screw (S)	Torx
DSSA-32/5	32	40	8,4	16	5	1003	1225	T07
DSSA-40/6	40	40	8,4	16	6	1003	1225	T07
DSSA-50/7	50	40	10,4	22	7	1003	1225	T07
DSSA-63/9	63	50	10,4	22	9	1003	1225	T07

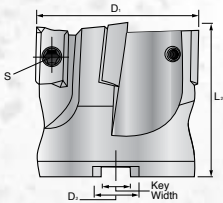

Arbor Style Holders for 1604 Insert

Millstar Part Number	Diameter (D1)	Height (L1)	Keyway	Bore (D2)	No. of Flutes	Insert size	Screw (S)	Torx
DSMA-40/4	40	40	8,4	16	4	1604	1240	T15
DSMA-50/5	50	40	10,4	22	5	1604	1240	T15
DSMA-63/6	63	50	10,4	27	6	1604	1240	T15
DSMA-80/7	80	50	12,4	27	7	1604	1240	T15
DSMA-100/8	100	50	14,4	32	8	1604	1240	T15
DSMA-125/8	120	63	16,4	40	8	1604	1240	T15
DSMA-160/9	160	63	16,4	40	9	1604	1240	T15

Screw On Heads for 1003 Insert

Millstar Part Number	Diameter	Length	Thread	Pilot Diameter	No. of Flutes	Insert size	Screw	Torx
DSSC-16/2	16	23	M8	8,5	2	1003	1425	T07
DSSC-20/3	20	30	M10	10,5	3	1003	1225	T07
DSSC-25/3	25	35	M12	12,5	3	1003	1425	T07

Screw On Heads for 1604 Insert

Millstar Part Number	Diameter	Length	Thread	Pilot Diameter	No. of Flutes	Insert size	Screw	Torx
DSMC-25/2	25	35	M12	12,5	2	1604	1440	T15
DSMC-32/3	32	43	M12	17	3	1604	1240	T15

Indexable Milling Program Tools for Aluminum Alloys

Indexable Milling Program Tools for Aluminum Alloys Contents

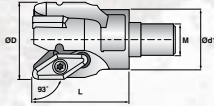
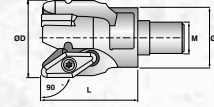
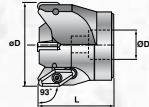
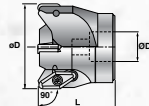
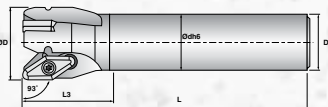
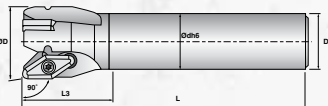
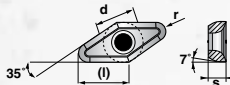
ASOC	Modular Screw-on Heads With Side Clearance	85	
ASON	Modular Screw-on Heads With No Side Clearance	85	
ASMC	Shell Milling Cutters With Side Clearance	85	
ASMN	Shell Milling Cutter With No Side Clearance	86	
AEMC	End Milling Cutter With Side Clearance	86	
AEMN	End Milling Cutter With No Side Clearance	86	
Insert Data		87	
Cutting Conditions		87	

Milling Cutters Identification System

Modular

Measurement System	Denotes Cutter for Non-Ferrous Metals & Plastics	SOC = Screw-On Cutter with Side Clearance SON = Screw-on Cutter with no Side Clearance SMC = Shell Milling Cutter with Side Clearance SMN = Shell Milling Cutter with no Side Clearance	Denotes Diameter Size	/	Denotes Number of Flutes
Metric	A	SOC	32	/	3

Shank

Measurement System	Denotes Cutter for Non-Ferrous Metals & Plastics	EMC = End Milling Shank Cutter	Denotes Diameter Size	-	Denotes Tool Cutter Length	-	Denotes Tool Diameter Shank
Metric	A	EMC	42	-	220	-	25
Metric	A	EMN	42	-	220	-	25

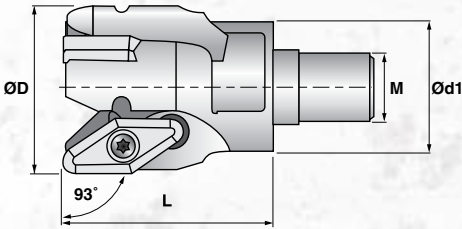

ASOC Modular Screw-On Heads

Tool Ordering Number	Dimensions (mm)					Use with			RPM Max
	ØD	L	Ød1	M	Z	Screw	Key	Inserts	
ASOC-25/3	25	50	21	M12	3	AIS-1	T7	VCGT-110308	30000
ASOC-32/3	32	50	29	M16	3	AIS-2	T15	VCGT-160412	28000
ASOC-42/3	42	50	29	M16	3	AIS-3	T20	VCGT-220530	24000

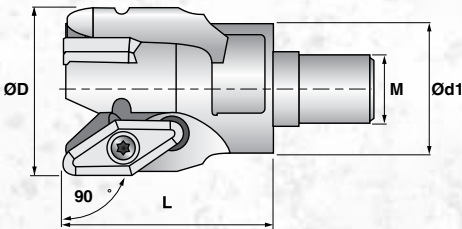

ASON Modular Screw-On Heads

Tool Ordering Number	Dimensions (mm)					Use with			RPM Max
	ØD	L	Ød1	M	Z	Screw	Key	Inserts	
ASON-25/2	25	35	18	M10	2	AIS-1	T7	VCGT-110308	30000
ASON-25/3	25	50	21	M12	3	AIS-1	T7	VCGT-110308	30000
ASON-32/3	32	50	29	M16	3	AIS-2	T15	VCGT-160412	24000
ASON-42/3	42	50	29	M16	3	AIS-3	T20	VCGT-220530	24000

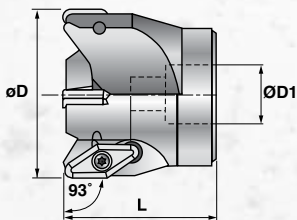

ASMC Shell Milling Cutters

Tool Ordering Number	Dimensions (mm)					Use with			RPM Max
	ØD	L	ØD1	Key Width	Z	Screw	Key	Inserts	
ASMC-50/3	50	55	22	10,4	3	AIS-2	T15	VCGT-160412	23000
ASMC-63/4	63	60	22	10,4	4	AIS-2	T15	VCGT-160412	20000
ASMC-80/4	80	60	27	12,4	4	AIS-3	T20	VCGT-220530	18000

Indexable Milling Program Tools for Aluminum Alloys

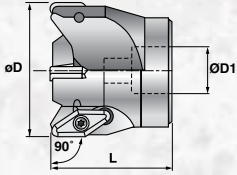

ASMN Shell Milling Cutters

Tool Ordering Number	Dimensions (mm)						Use with			RPM Max
	ØD	L	ØD1	Key Width	L2	Z	Screw	Key	Inserts	
ASMN-42/3	42	55	16	8,4	15	3	AIS-3	T20	VCGT-220530	24000
ASMN-50/3	50	55	22	10,4	13	3	AIS-2	T15	VCGT-160412	23000
ASMN-52/3	52	55	22	10,4	15	3	AIS-3	T20	VCGT-220530	22000
ASMN-63/4	63	60	22	10,4	13	4	AIS-2	T15	VCGT-160412	20000
ASMN-66/4	66	60	27	10,4	15	4	AIS-3	T20	VCGT-220530	19000
ASMN-80/5	80	60	27	12,4	15	5	AIS-3	T20	VCGT-220530	18000
ASMN-100/5	100	65	32	14,4	15	5	AIS-3	T20	VCGT-220530	16000

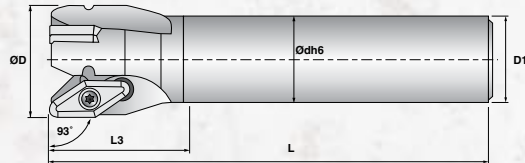

AEMC End Milling Cutters

Tool Ordering Number	Dimensions (mm)						Use with			RPM Max
	ØD	L	L1	D1	L3	Z	Screw	Key	Inserts	
AEMC-25/3	25	140	10	20	40	3	AIS-1	T7	VCGT-110308	30000
AEMC-32/3	32	140	13,5	25	50	3	AIS-2	T15	VCGT-160412	28000
AEMC-42/3	42	140	15	32	50	3	AIS-3	T20	VCGT-220530	24000

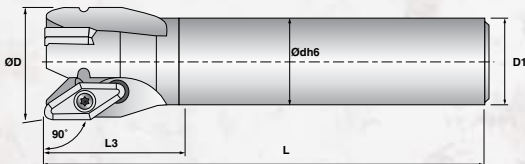

AEMN End Milling Cutters

Tool Ordering Number	Dimensions (mm)						Use with			RPM Max
	ØD	L	L1	D1	L3	Z	Screw	Key	Inserts	
AEMN-20/2-L100	20	100	10	18	30	2	AIS-1	T7	VCGT-110308	30000
AEMN-20/2-L200	20	200	10	18	30	2	AIS-1	T7	VCGT-110308	26000
AEMN-25/3-L140	25	140	10	20	40	3	AIS-1	T7	VCGT-110308	30000
AEMN-25/3-L240	25	240	10	20	40	3	AIS-1	T7	VCGT-110308	26000
AEMN-32/3-L140	32	140	13	25	50	3	AIS-2	T15	VCGT-160412	28000
AEMN-32/3-L240	32	240	13	25	50	3	AIS-2	T15	VCGT-160412	24000
AEMN-42/3-L140	42	140	15	32	50	3	AIS-3	T20	VCGT-220530	24000
AEMN-42/3-L240	42	240	15	32	50	3	AIS-3	T20	VCGT-220530	20000

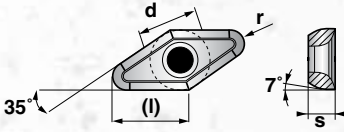

Insert Data

Tool Ordering Number	Dimensions				
	l	s	d	r	Screw
VCGT-110308	11	3.18	2.8	0.8	AIS-1
VCGT-160412	16.6	4.76	4.4	1.2	AIS-2
VCGT-220530	22	5.56	5.5	3	AIS-3

Cutting Conditions: Recommended Cutting Speed

Alloy Group	Rm (Mpa)	Roughing					Finishing				
		Speed Vc(m/min)		Feed Fz(mm/tooth)		D.O.C. Ap(m/min)	Speed Vc(m/min)		Feed Fz(mm/tooth)		D.O.C. Ap(m/min)
		Min	Max	Min	Max	Max	Min	Max	Min	Max	Max
AL Alloy	<280	600	2000	0,2	0,4	10	600	2000	0,15	0,2	10
Al-Cu	300-460	400	2000	0,25	0,3	10	400	2500	0,15	0,25	10
Al-Mg-Si	200-400	400	2000			10	400	2500			10
Al-Zn	400-600	400	2000	0,25	0,35	10	400	3000	0,15	0,25	10
Al-Si <12%Si	350-380	200	800	0,2	0,25	10	200	1000	0,15	0,2	10
Copper alloy		400	500		0,2	10	400	500		0,2	10
Mg. alloys		400	450		0,2	10	400	450		0,2	10
Thermoplastics		300	350		0,15	10	300	350		0,15	10
Duro-plastics		180	200		0,15	10	180	200		0,15	10

High Feed Indexable Milling Program Tools

With new five- and six-axis CNC grinding technology, Millstar has been able to create some of the most sophisticated and complex geometries in use today. With this increase in grinding technology, high-feed tooling has been reborn. The definition of high-feed geometry is producing a positive cutting edge out of a series of continuous radii with no tangent point to induce wear. The geometry must allow the chip to flow up and out of the cut quickly and smoothly. This cutting motion allows the use of heavy chip loads to achieve very high feed rates.



High Feed Indexable Milling Program Tool Contents

HFSC	Modular Screw-on Heads	90	
HFA	Shell Milling Cutters	90	
HFSS	End Milling Cutters	91	
Insert Data		92	
Cutting Conditions Data		93-97	

Milling Cutters Identification System

Modular						
Measurement System	Denotes High Feed Cutter	SC = Screw-on Cutter A = Shell Cutter	Denotes Diameter Size		Denotes Number of Flutes	
Imperial	HF	SC	1000	/	3	
Metric	HF	SC	25	/	3	
Shank						
Measurement System	Denotes High Feed Cutter	Denotes Shank Cutter	Denotes Diameter Size		Denotes Tool Cutter Length	Denotes Tool Diameter Shank
Imperial	HF	SS	1000	-	5.5	1000
Metric	HF	SS	25	-	140	25

High Feed Indexable Milling Program Tools

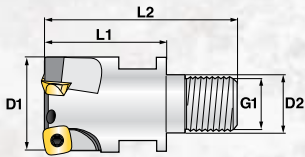

HFSC - Modular Screw-On Heads

Tool Ordering Number	Dimensions					Thread G1	Screw	Clamp	Key	Use with Inserts	CAM R
	ØD	L1	L2	D2	Z						
HFSC-20/2	20	31	49	10,5	2	M10	HFIS 1	-	T8	HFCl-09T3	2,27
HFSC-25/3	25	32	54	12,5	3	M12	HFIS 1	-	T8	HFCl-09T3	2,27
HFSC-30/4	30	40	63	17,0	4	M16	HFIS 1	-	T8	HFCl-09T3	2,27
HFSC-32/4	32	40	63	17,0	4	M16	HFIS 1	-	T8	HFCl-09T3	2,27
HFSC-32/3	32	40	63	17,0	3	M16	HFIS 2	HFIC-1	T15	HFCl-1204 HFCl-1204	3,52
HFSC-42/4	42	40	63	17,0	4	M16	HFIS 2	HFIC-1	T15	HFCl-1204 HFCl-1204	3,52

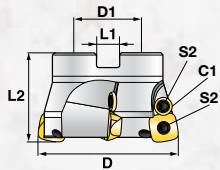

HFA - Shell Milling Cutters

Tool Ordering Number	Dimensions					Screw S1	Screw S2	Clamp C1	Key	Use with Inserts	CAM R
	ØD	ØD1	L1	L2	Z						
HFA-42/4	42	16	8,4	40	4	HFIS-2	HFIS-2	HFIC-1	T15	HFCl-1204 HFCl-1204	3,52
HFA-50/5	50	22	10,4	40	5	HFIS-2	HFIS-2	HFIC-1	T15	HFCl-1204 HFCl-1204	3,52
HFA-52/5	52	22	10,4	50	5	HFIS-2	HFIS-2	HFIC-1	T15	HFCl-1204 HFCl-1204	3,52
HFA-63/6	63	27	12,4	50	6	HFIS-2	HFIS-2	HFIC-1	T15	HFCl-1204 HFCl-1204	3,52
HFA-66/6	66	27	12,4	50	6	HFIS-2	HFIS-2	HFIC-1	T15	HFCl-1204 HFCl-1204	3,52
HFA-80/7	80	27	12,4	50	7	HFIS-2	HFIS-2	HFIC-1	T15	HFCl-1204 HFCl-1204	3,52
HFA-100/8	100	32	14,4	50	8	HFIS-2	HFIS-2	HFIC-1	T15	HFCl-1204 HFCl-1204	3,52

High Feed Indexable Milling Program Tools

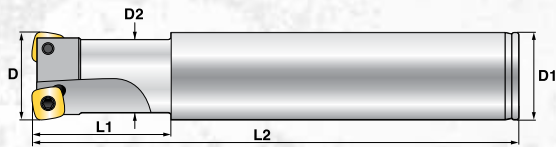

HFSS - End Milling Cutters

Tool Ordering Number	Dimensions					Screw	Clamp C1	Key	Use with Inserts	CAM R
	ØD	ØD1	L1	L2	Z					
HFSS-20-110-20	20	20	30	110	2	HFIS-1	-	T8	HFCI-09T3	2,27
HFSS-25-100-25	25	25	30	100	3	HFIS-1	-	T8	HFCI-09T3	2,27
HFSS-25-140-25	25	25	40	140	3	HFIS-1	-	T8	HFCI-09T3	2,27
HFSS-25-240-25	25	25	40	240	3	HFIS-1	-	T8	HFCI-09T3	2,27
HFSS-32-140-32	32	32	40	140	4	HFIS-1	-	T8	HFCI-09T3	2,27
HFSS-32-240-32	32	32	40	240	4	HFIS-1	-	T8	HFCI-09T3	2,27
HFSS-40-140-32	40	32	-	140	4	HFIS-2	HFIC-1	T15	HFCI-1204 HFCR-1204	3,52
HFSS-40-240-32	40	32	-	240	4	HFIS-2	HFIC-1	T15	HFCI-1204 HFCR-1204	3,52

High Feed Indexable Milling Program Tools

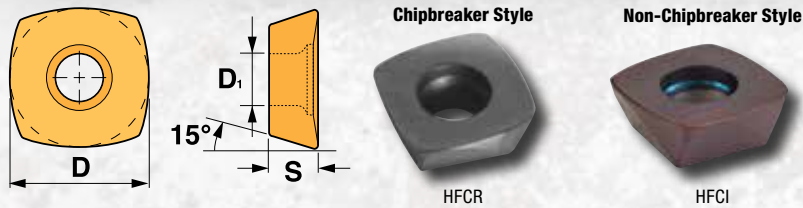

Insert Data

Tool Ordering Number	Dimensions			Grade		CAM
	D	S	D1	XRN	HSN	R
HFCl-09T3	9,525	3,97	4,4	•	•	2,27
HFCl-1204	12,700	4,76	3,4	•	•	3,52
HFCR-09T3	9,525	3,97	4,4	•	•	2,27
HFCR-1204	12,700	4,76	3,4	•	•	3,52

Machining Application Data

Tool Ordering Number	Dimensions				Helical Interpolation	
	ØD	ØDh	Ap	F	ØDh min	ØDh max
HFSC-20/2	20	9	1	8,8	26,3	38,1
HFSC-25/3	25	9	1	13,8	36,3	48,1
HFSC-30/4	30	9	1	18,8	46,3	58,1
HFSC-32/4	32	9	1	20,8	50,3	62,1
HFSC-32/3	32	12	1,7	15,4	44,6	61,8
HFSC-42/4	42	12	1,7	25,4	64,6	81,8
HFSS-20-110-20	20	9	1	8,8	26,3	38,1
HFSS-25-100-25	25	9	1	13,8	36,3	48,1
HFSS-25-140-25	25	9	1	13,8	36,3	48,1
HFSS-25-240-25	25	9	1	13,8	36,3	48,1
HFSS-32-140-32	32	9	1	20,8	50,3	62,1
HFSS-32-240-32	32	9	1	20,8	50,3	62,1
HFSS-40-140-32	40	9	1	28,8	66,3	78,1
HFSS-40-240-32	40	12	1,7	23,4	60,6	77,8
HFSS-20-110-20	20	12	1,7	8,8	26,3	38,1
HFA-42/4	42	12	1,7	25,4	64,6	81,8
HFA-50/5	50	12	1,7	33,4	80,5	97,8
HFA-52/5	52	12	1,7	35,4	84,5	101,8
HFA-63/6	63	12	1,7	46,4	106,5	123,8
HFA-66/6	66	12	1,7	49,4	112,5	129,8
HFA-80/7	80	12	1,7	63,4	140,5	157,8

- For Slant Milling or Helical Interpolation decrease the recommended feed by 30%.
- In case of Helical Interpolation do not exceed the max Ap/revolution.
- For Plunging use 50% of recommended feed only.
- For insert HFCl 09T3 the max Ae is: 0.200 • For insert HFCl 1204 the max Ae is: 0.250

The values of "n" and "Vf" in the tables on the following pages are computed. In the application, use the closest (up side) speed from the range of the machine tool. The cutting parameters have to be adjusted accordingly to the rigidity of the machine-tool and working piece.

In case of hard steel alloy of 50-55 HRC decrease by 30% the Ap, Vc and feed.

Helical Interpolation

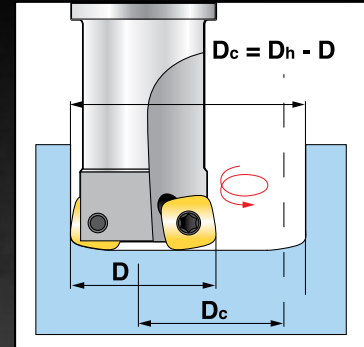

Slant Milling

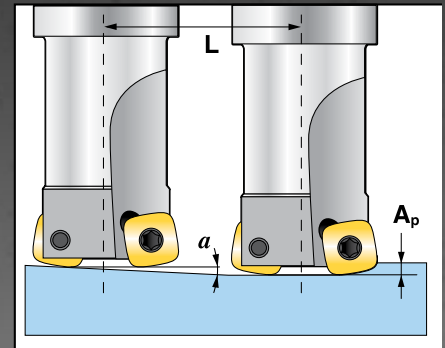

Plunge Milling

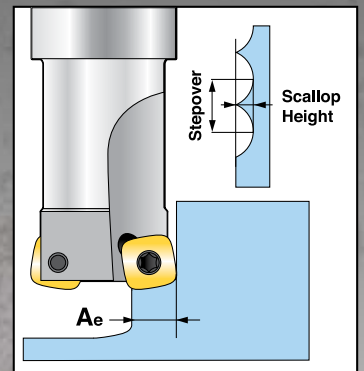

Facing - Max Flat

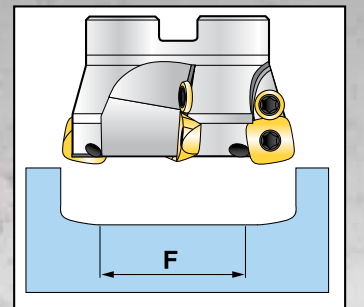

High Feed Indexable Milling Program Tools

Cutting Conditions Data

Cutter	Insert	Grade	Work Piece Material	Overhang	n	Vc	Vf	fz	Ap	Ae
					RPM	mm/min	mm/min	mm/tooth	mm	mm
HFSC-20/2	HFCI-09T3	HSN-XRN	Alloy Steel <32HRC	<3D	3025	190	8471	1,4	0,6	<15
				3D-5D	2229	140	3567	0,8	0,6	<15
				5D-7D	2070	130	3312	0,8	0,5	<15
				>7D	1433	90	2293	0,8	0,4	<15
			Tool Steel 32-42HRC	<3D	2548	160	7134	1,4	0,4	<15
				3D-5D	2070	130	3312	0,8	0,5	<15
				5D-7D	1911	120	3057	0,8	0,4	<15
				>7D	1433	90	2293	0,8	0,3	<15
			Tool Steel 42-52HRC	<3D	2229	140	5350	1,2	0,4	<15
				3D-5D	1592	100	2548	0,8	0,4	<15
				5D-7D	1592	100	2548	0,8	0,3	<15
				>7D	1433	90	1720	0,6	0,2	<15
			Cast Iron	<3D	2866	180	9172	1,6	0,8	<15
				3D-5D	2229	140	5350	1,2	0,8	<15
				5D-7D	2070	130	4968	1,2	0,6	<15
				>7D	1433	90	3439	1,2	0,5	<15
HFSC 25/3	HFCI-09T3	HSN-XRN	Alloy Steel <32HRC	<3D	2420	190	11618	1,6	0,6	<20
				3D-5D	1783	140	5350	1	0,6	<20
				5D-7D	1656	130	4968	1	0,5	<20
				>7D	1146	90	3439	1	0,4	<20
			Alloy Steel 32-42HRC	<3D	2038	160	9783	1,6	0,4	<20
				3D-5D	1656	130	4968	1	0,5	<20
				5D-7D	1529	120	4586	1	0,4	<20
				>7D	1146	90	3439	1	0,3	<20
			Tool Steel 42-52HRC	<3D	1783	140	7490	1,4	0,4	<20
				3D-5D	1274	100	3057	0,8	0,4	<20
				5D-7D	1274	100	3057	0,8	0,3	<20
				>7D	1146	90	2064	0,6	0,2	<20
			Cast Iron	<3D	2293	180	11006	1,6	0,8	<20
				3D-5D	1783	140	6420	1,2	0,8	<20
				5D-7D	1656	130	5962	1,2	0,6	<20
				>7D	1146	90	4127	1,2	0,5	<20
HFSC-30/4	HFCI-09T3	HSN-XRN	Alloy Steel <32HRC	<3D	2017	190	12102	1,5	0,6	<21
				3D-5D	1486	140	5350	0,9	0,6	<21
				5D-7D	1380	130	4968	0,9	0,5	<21
				>7D	955	90	3439	0,9	0,4	<21
			Alloy Steel 32-42HRC	<3D	1699	160	10191	1,5	0,4	<21
				3D-5D	1380	130	4968	0,9	0,5	<21
				5D-7D	1274	120	4586	0,9	0,4	<21
				>7D	955	90	3439	0,9	0,3	<21
			Tool Steel 42-52HRC	<3D	1486	140	7134	1,2	0,4	<21
				3D-5D	1062	100	3397	0,8	0,4	<21
				5D-7D	1062	100	2548	0,6	0,3	<21
				>7D	955	90	2293	0,6	0,2	<21
			Cast Iron	<3D	1911	180	12229	1,6	0,8	<21
				3D-5D	1486	140	7134	1,2	0,8	<21
				5D-7D	1380	130	6624	1,2	0,6	<21
				>7D	955	90	4586	1,2	0,4	<21

High Feed Indexable Milling Program Tools

Cutting Conditions Data

Cutter	Insert	Grade	Work Piece Material	Overhang	n	Vc	Vf	fz	Ap	Ae
					RPM	mm/min	mm/min	mm/tooth	mm	mm
HFSC-32/4	HFCI-09T3	HSN-XRN	Alloy Steel <32HRC	<3D	1891	190	11346	1,5	0,6	<22
				3D-5D	1393	140	5016	0,9	0,6	<22
				5D-7D	1294	130	4658	0,9	0,5	<22
				>7D	896	90	3225	0,9	0,4	<22
			Alloy Steel 32-42HRC	<3D	1592	160	9554	1,5	0,4	<22
				3D-5D	1294	130	4658	0,9	0,5	<22
				5D-7D	1194	120	4299	0,9	0,4	<22
				>7D	896	90	3225	0,9	0,3	<22
			Tool Steel 42-52HRC	<3D	1393	140	6688	1,2	0,4	<22
				3D-5D	995	100	3185	0,8	0,4	<22
				5D-7D	995	100	2389	0,6	0,3	<22
				>7D	896	90	2150	0,6	0,2	<22
			Cast Iron	<3D	1791	180	11465	1,6	0,8	<22
				3D-5D	1393	140	6688	1,2	0,8	<22
				5D-7D	1294	130	6210	1,2	0,6	<22
				>7D	896	90	4299	1,2	0,4	<22
HFSC-32/3	HFCI-1204	HSN-XRN	Alloy Steel <32HRC	<3D	1891	190	8509	1,5	1	<22
				3D-5D	1393	140	3762	0,9	1,2	<22
				5D-7D	1294	130	3493	0,9	1	<22
				>7D	896	90	2418	0,9	0,8	<22
			Alloy Steel 32-42HRC	<3D	1592	160	7166	1,5	0,8	<22
				3D-5D	1294	130	3493	0,9	1	<22
				5D-7D	1194	120	3225	0,9	0,8	<22
				>7D	896	90	2418	0,9	0,6	<22
			Tool Steel 42-52HRC	<3D	1393	140	5852	1,4	0,8	<22
				3D-5D	995	100	2389	0,8	0,6	<22
				5D-7D	995	100	2389	0,8	0,5	<22
				>7D	896	90	1612	0,6	0,4	<22
			Cast Iron	<3D	1791	180	9674	1,8	1,2	<22
				3D-5D	1393	140	5852	1,4	1	<22
				5D-7D	1294	130	5434	1,4	0,8	<22
				>7D	896	90	3762	1,4	0,6	<22
HFSC-42/4	HFCI-1204	HSN-XRN	Alloy Steel <32HRC	<3D	1441	190	8644	1,5	1	<28
				3D-5D	1062	140	3822	0,9	1,2	<28
				5D-7D	986	130	3549	0,9	1	<28
				>7D	682	90	2457	0,9	0,8	<28
			Alloy Steel 32-42HRC	<3D	1213	160	7279	1,5	0,8	<28
				3D-5D	986	130	3549	0,9	1	<28
				5D-7D	910	120	3276	0,9	0,8	<28
				>7D	682	90	2457	0,9	0,6	<28
			Tool Steel 42-52HRC	<3D	1062	140	5945	1,4	0,8	<28
				3D-5D	758	100	2426	0,8	0,6	<28
				5D-7D	758	100	2426	0,8	0,5	<28
				>7D	682	90	1638	0,6	0,4	<28
			Cast Iron	<3D	1365	180	9827	1,8	1,2	<28
				3D-5D	1062	140	5945	1,4	1	<28
				5D-7D	986	130	5520	1,4	0,8	<28
				>7D	682	90	3822	1,4	0,6	<28

High Feed Indexable Milling Program Tools

Cutting Conditions Data

Cutter	Insert	Grade	Work Piece Material	Overhang	n	Vc	Vf	fz	Ap	Ae
					RPM	mm/min	mm/min	mm/tooth	mm	mm
HFSS-20-110-20	HFCI-09T3	HSN-XRN	Alloy Steel <32HRC	<3D	3025	190	8471	1,4	0,6	<15
				3D-5D	2229	140	3567	0,8	0,6	<15
				5D-7D	2070	130	3312	0,8	0,5	<15
				>7D	1433	90	2293	0,8	0,4	<15
			Tool Steel 32-42HRC	<3D	2548	160	7134	1,4	0,4	<15
				3D-5D	2070	130	3312	0,8	0,5	<15
				5D-7D	1911	120	3057	0,8	0,4	<15
				>7D	1433	90	2293	0,8	0,3	<15
			Tool Steel 42-52HRC	<3D	2229	140	5350	1,2	0,4	<15
				3D-5D	1592	100	2548	0,8	0,4	<15
				5D-7D	1592	100	2548	0,8	0,3	<15
				>7D	1433	90	1720	0,6	0,2	<15
			Cast Iron	<3D	2866	180	9172	1,6	0,8	<15
				3D-5D	2229	140	5350	1,2	0,8	<15
				5D-7D	2070	130	4968	1,2	0,6	<15
				>7D	1433	90	3439	1,2	0,5	<15
HFSS-25-110-25 HFSS-25-140-25 HFSS-25-240-25	HFCI-09T3	HSN-XRN	Alloy Steel <32HRC	<3D	2420	190	11618	1,6	0,6	<20
				3D-5D	1783	140	5350	1	0,6	<20
				5D-7D	1656	130	4968	1	0,5	<20
				>7D	1146	90	3439	1	0,4	<20
			Tool Steel 32-42HRC	<3D	2038	160	9783	1,6	0,4	<20
				3D-5D	1656	130	4968	1	0,5	<20
				5D-7D	1529	120	4586	1	0,4	<20
				>7D	1146	90	3439	1	0,3	<20
			Tool Steel 42-52HRC	<3D	1783	140	7490	1,4	0,4	<20
				3D-5D	1274	100	3057	0,8	0,4	<20
				5D-7D	1274	100	3057	0,8	0,3	<20
				>7D	1146	90	2064	0,6	0,2	<20
			Cast Iron	<3D	2293	180	11006	1,6	0,8	<20
				3D-5D	1783	140	6420	1,2	0,8	<20
				5D-7D	1656	130	5962	1,2	0,6	<20
				>7D	1146	90	4127	1,2	0,5	<20
HFSS 32-140-32 HFSS-32-240-32	HFCI-09T3	HSN-XRN	Alloy Steel <32HRC	<3D	2017	190	12102	1,5	0,6	<21
				3D-5D	1486	140	5350	0,9	0,6	<21
				5D-7D	1380	130	4968	0,9	0,5	<21
				>7D	896	90	3225	0,9	0,4	<21
			Tool Steel 32-42HRC	<3D	1699	160	10191	1,5	0,4	<21
				3D-5D	1380	130	4968	0,9	0,5	<21
				5D-7D	1274	120	4586	0,9	0,4	<21
				>7D	896	90	3225	0,9	0,3	<21
			Tool Steel 42-52HRC	<3D	1486	140	7134	1,2	0,4	<21
				3D-5D	1062	100	3397	0,8	0,4	<21
				5D-7D	1062	100	2548	0,6	0,3	<21
				>7D	896	90	2150	0,6	0,2	<21
			Cast Iron	<3D	1911	180	12229	1,6	0,8	<21
				3D-5D	1486	140	7134	1,2	0,8	<21
				5D-7D	1380	130	6624	1,2	0,6	<21
				>7D	896	90	4299	1,2	0,4	<21

High Feed Indexable Milling Program Tools

Cutting Conditions Data

Cutter	Insert	Grade	Work Piece Material	Overhang	n	Vc	Vf	fz	Ap	Ae
					RPM	mm/min	mm/min	mm/tooth	mm	mm
HFSS-40-140-32 HFSS-40-240-32	HFCI-1204	HSN-XRN	Alloy Steel <32HRC	<3D	1441	190	8644	1,5	1	<28
				3D-5D	1062	140	3822	0,9	1,2	<28
				5D-7D	986	130	3549	0,9	1	<28
				>7D	717	90	2580	0,9	0,8	<28
			Tool Steel 32-42HRC	<3D	1213	160	7279	1,5	0,8	<28
				3D-5D	986	130	3549	0,9	1	<28
				5D-7D	910	120	3276	0,9	0,8	<28
				>7D	717	90	2580	0,9	0,6	<28
			Tool Steel 42-52HRC	<3D	1062	140	5945	1,4	0,8	<28
				3D-5D	758	100	2426	0,8	0,6	<28
				5D-7D	758	100	2426	0,8	0,5	<28
				>7D	717	90	1720	0,6	0,4	<28
			Cast Iron	<3D	1365	180	9827	1,8	1,2	<28
				3D-5D	1062	140	5945	1,4	1	<28
				5D-7D	986	130	5520	1,4	0,8	<28
				>7D	717	90	4013	1,4	0,6	<28
HFA-42/4	HFCI-1204	HSN-XRN	Alloy Steel <32HRC	<3D	1441	190	8644	1,5	1	<28
				3D-5D	1062	140	3822	0,9	1,2	<28
				5D-7D	986	130	3549	0,9	1	<28
				>7D	682	90	2457	0,9	0,8	<28
			Tool Steel 32-42HRC	<3D	1213	160	7279	1,5	0,8	<28
				3D-5D	986	130	3549	0,9	1	<28
				5D-7D	910	120	3276	0,9	0,8	<28
				>7D	682	90	2457	0,9	0,6	<28
			Tool Steel 42-52HRC	<3D	1062	140	5945	1,4	0,8	<28
				3D-5D	758	100	2426	0,8	0,6	<28
				5D-7D	758	100	2426	0,8	0,5	<28
				>7D	682	90	1638	0,6	0,4	<28
			Cast Iron	<3D	1365	180	9827	1,8	1,2	<28
				3D-5D	1062	140	5945	1,4	1	<28
				5D-7D	986	130	5520	1,4	0,8	<28
				>7D	682	90	3822	1,4	0,6	<28
HFA-50/5	HFCI-1204	HSN-XRN	Alloy Steel <32HRC	<3D	1210	190	8471	1,4	0,7	<35
				3D-5D	892	140	4459	1	1	<35
				5D-7D	828	130	4140	1	0,8	<35
				>7D	573	90	2293	0,8	0,6	<35
			Tool Steel 32-42HRC	<3D	1019	160	6115	1,2	0,6	<35
				3D-5D	828	130	4140	1	0,6	<35
				5D-7D	764	120	3822	1	0,6	<35
				>7D	573	90	2293	0,8	0,4	<35
			Tool Steel 42-52HRC	<3D	892	140	5350	1,2	0,6	<35
				3D-5D	637	100	2548	0,8	0,5	<35
				5D-7D	637	100	2548	0,8	0,4	<35
				>7D	573	90	2293	0,8	0,3	<35
			Cast Iron	<3D	1146	180	9172	1,6	1	<35
				3D-5D	892	140	5350	1,2	0,8	<35
				5D-7D	828	130	4968	1,2	0,6	<35
				>7D	573	90	3439	1,2	0,4	<35

High Feed Indexable Milling Program Tools

Cutting Conditions Data

Cutter	Insert	Grade	Work Piece Material	Overhang	n	Vc	Vf	fz	Ap	Ae
					RPM	mm/min	mm/min	mm/tooth	mm	mm
HFA-52/5	HFCI-1204	HSN-XRN	Alloy Steel <32HRC	<3D	1164	190	8146	1,4	0,7	<36
				3D-5D	857	140	4287	1	1	<36
				5D-7D	796	130	3981	1	0,8	<36
				>7D	551	90	2205	0,8	0,6	<36
			Tool Steel 32-42HRC	<3D	980	160	5879	1,2	0,6	<36
				3D-5D	796	130	3981	1	0,6	<36
				5D-7D	735	120	3675	1	0,6	<36
				>7D	551	90	2205	0,8	0,4	<36
			Tool Steel 42-52HRC	<3D	857	140	5145	1,2	0,6	<36
				3D-5D	612	100	2450	0,8	0,5	<36
				5D-7D	612	100	2450	0,8	0,4	<36
				>7D	551	90	2205	0,8	0,3	<36
			Cast Iron	<3D	1102	180	8819	1,6	1	<36
				3D-5D	857	140	5145	1,2	0,8	<36
				5D-7D	796	130	4777	1,2	0,6	<36
				>7D	551	90	3307	1,2	0,4	<36
HFA-63/6	HFCI-1204	HSN-XRN	Alloy Steel <32HRC	<3D	960	190	8068	1,4	0,7	<45
				3D-5D	708	140	4246	1	1	<45
				5D-7D	657	130	3943	1	0,8	<45
				>7D	455	90	2184	0,8	0,6	<45
			Tool Steel 32-42HRC	<3D	809	160	5823	1,2	0,6	<45
				3D-5D	657	130	3943	1	0,6	<45
				5D-7D	607	120	3640	1	0,6	<45
				>7D	455	90	2184	0,8	0,4	<45
			Tool Steel 42-52HRC	<3D	708	140	5096	1,2	0,6	<45
				3D-5D	506	100	2426	0,8	0,5	<45
				5D-7D	506	100	2426	0,8	0,4	<45
				>7D	455	90	2184	0,8	0,3	<45
			Cast Iron	<3D	910	180	8735	1,6	1	<45
				3D-5D	708	140	5096	1,2	0,8	<45
				5D-7D	657	130	4732	1,2	0,6	<45
				>7D	455	90	3276	1,2	0,4	<45
HFA-66/6	HFCI-1204	HSN-XRN	Alloy Steel <32HRC	<3D	917	190	7701	1,4	0,7	<47
				3D-5D	676	140	4053	1	1	<47
				5D-7D	627	130	3764	1	0,8	<47
				>7D	434	90	2085	0,8	0,6	<47
			Tool Steel 32-42HRC	<3D	772	160	5559	1,2	0,6	<47
				3D-5D	627	130	3764	1	0,6	<47
				5D-7D	579	120	3474	1	0,6	<47
				>7D	434	90	2085	0,8	0,4	<47
			Tool Steel 42-52HRC	<3D	676	140	4864	1,2	0,6	<47
				3D-5D	483	100	2316	0,8	0,5	<47
				5D-7D	483	100	2316	0,8	0,4	<47
				>7D	434	90	2085	0,8	0,3	<47
			Cast Iron	<3D	869	180	8338	1,6	1	<47
				3D-5D	676	140	4864	1,2	0,8	<47
				5D-7D	627	130	4517	1,2	0,6	<47
				>7D	434	90	3127	1,2	0,4	<47

High Performance Solid Carbide End Mills

Millstar offers a wide variety of Solid Carbide End Mills that are designed for high performance machining. Our impressive lineup features a large selection of High Feed Solid Carbide End Mills that achieve the highest performance in the industry. Our End Mills can be used in a broad spectrum of materials such as hardened steels, soft steels, titanium, cobalt chrome and many more.



Solid Carbide End Mill Program Tool Contents

HFM4	High Feed Four Flute Solid Carbide	101		BMT		107-109	
HFM6	High Feed with Coolant Through 6 Flute	101		BMNL	Ball Nose Taper Neck	110	
HFM True Radius	High Feed Bullnose Series	101		BMNL	Ball-Extended Reach, Taper Nose	110	
Cutting Conditions		102		BMA	3 Flute – Ball 45°	110	
Quad Force		103		BM2	2 Flute – Long Series – Ball	110	
EMS	Square	104		BM4	4 Flute – Long Series – Ball	111	
EMS2	2 Flute – Square	104		BM220	220° 2 Flute – Ball	111	
EMS4	4 Flute – Square	104		BM4T	Ball	111	
EMS2...LL	2 Flute Long Series – Square	104		EMB	Square-Bullnose	112	
EMS4...LL	4 Flute Long Series – Square	104		EMBT		113-115	
EMSA	3 Flute – 45°	105		EMR	Square End Bull Nose with Corner Radius, Extended Reach Taper Nose	116	
EMV4	4 Flute Variable – Square, 45° Chamfer	105		IMB-2-LL	Bull Nose Long Length 2 Flute	116	
EMV5	5 Flute Variable Square End	105		IMB-4-LL	Bull Nose Long Length 4 Flute NEW TOOL	117	
EMV5	5 Flute Variable With Corner Radius	105		TOM	Toroid	117	
BM	Ball	106					
BMS	72 Angle 30°	106					

Solid Carbide End Mills

Millstar's new High Performance and ultra-precise solid carbide end mills were designed for high speed, high velocity and hard steel milling. Designed with specially selected premium sub-micron carbide substrate, special tool geometry and proprietary heat-defying EXALON tool coating, these tools made in the United States, and are competitively priced. Ideal choices for accurately and aggressively machining products in:

- **Mold and die making:** injection molds, glass molds, forging dies, extrusion dies.
- **Aerospace:** engine, landing gear and tail hook components, structural components, blisks, airfoil machining and forging dies, helicopter rotor components.
- **Power generating:** turbine blades and other components.
- **Medical:** hip and knee replacement joints, surgical instruments, medical device molds.
- **Automotive:** stamping dies, wheel and tire molds, ball joints, cam shaft machining, racing engine details, bumper and other injection molds, die cast dies, forging dies for crank and cam shafts, connecting rods, steering knuckles and yokes.
- **Consumer products:** molds for cake forms and baking dishes, cell phones, lawn chairs, trash cans, toys, bottles, recyclable cutlery and dishes, jewelry, golf clubs, safety helmets, computer and accessory housings.

NA

Non-coated grade.

HSN

Millstar's new coating is a multi-layer hybrid Nano coating. This new coating has very good heat resistance and high hardness. The HSN coating is designed for use in HSM of Heat Treated materials up to 72 HRC.

ALTiN-EXALON (TLN) (EX)

Titanium Aluminum Nitride advanced PVD coating. A special, improved ALTiN coating approaching surface hardness of CBN on a tough substrate. Recommended for tough and hard metal machining applications.

Custom tool coatings for specific applications are available by request.

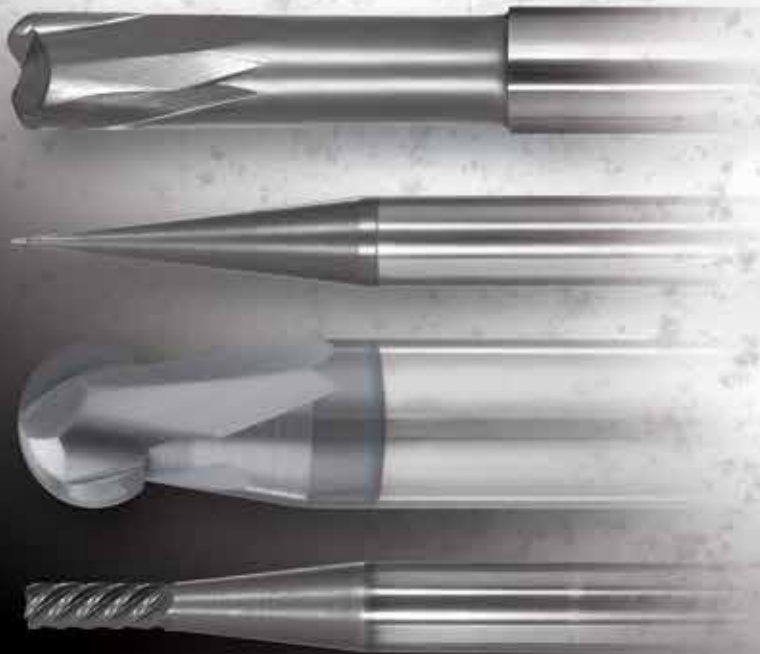

Solid Carbide End Mill Program - High Feed

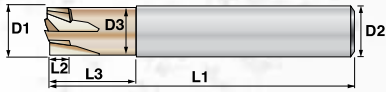

HMF4 - High Feed Four Flute Solid Carbide

Tool Ordering No.	Diameter (D1)	Programmable Radius	Shank Diameter (D2)	Neck Diameter (D3)	Length of Cut (L2)	Neck Length (L3)	Overall Length (L1)	Step Over Ae	Depth of Cut Ap	Feed per Tooth Fz
HFM4-02	2	0,234	6	1,85	2,2	12,0	76,0	1,50	0,09	0,03 - 0,05
HFM4-03	3	0,365	6	2,74	2,8	16,0	76,0	2,25	0,12	0,07 - 0,14
HFM4-04	4	0,465	6	3,60	3,5	20,0	76,0	3,00	0,15	0,10 - 0,20
HFM4-05	5	0,597	6	4,75	3,5	20,0	76,0	3,75	0,20	0,12 - 0,24
HFM4-06	6	0,731	6	5,61	3,8	25,0	76,0	4,50	0,24	0,14 - 0,28
HFM4-08	8	0,977	8	7,62	4,0	30,0	76,0	6,00	0,32	0,18 - 0,36
HFM4-10	10	1,226	10	9,60	4,3	33,0	100,0	7,50	0,40	0,22 - 0,44
HFM4-12	12	1,651	12	11,61	4,6	38,0	101,0	9,09	0,48	0,27 - 0,54

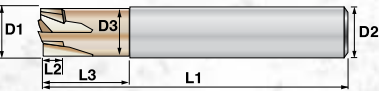

HFM6 - High Feed Six Flute Solid Carbide w/Coolant Through

Tool Ordering No.	Diameter (D1)	Programmable Radius	Shank Diameter (D2)	Neck Diameter (D3)	Length of Cut (L2)	Neck Length (L3)	Overall Length (L1)	Step Over Ae	Depth of Cut Ap	Feed per Tooth Fz
HFM6-06-76-CH	6	0,57	6	5,59	4	12	76	4,5	0,24	0,14-0,28
HFM6-08-76-CH	8	0,94	8	7,49	4	12	76	6,0	0,32	0,18-0,36
HFM6-10-76-CH	10	1,10	10	9,53	4,5	14	76	7,5	0,40	0,22-0,44
HFM6-12-100-CH	12	1,32	12	11,61	4,5	14	100	9,0	0,48	0,27-0,54
HFM6-16-100-CH	16	1,80	16	15,49	5	15	100	12,0	0,52	0,30-0,60

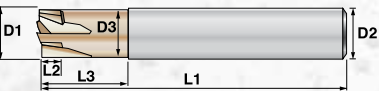

HFM True Radius

Tool Ordering No.	Diameter (D1)	Programmable Radius	Shank Diameter (D2)	Neck Diameter (D3)	Length of Cut (L2)	Neck Length (L3)	Overall Length (L1)	Step Over Ae	Depth of Cut Ap	Feed per Tooth Fz
HFM4-04-0.5R-50	4	0,5	4	3,6	3	6	50	3,0	0,16	0,08-0,14
HFM4-06-0.5R-70	6	0,5	6	5,61	3,5	9	70	4,5	0,24	0,14-0,28
HFM4-06-1.5R	6	1,5	6	5,61	3,5	9	76	4,5	0,24	0,14-0,28
HFM4-08-0.5R-70	8	0,5	8	7,6	4	12	70	6,0	0,32	0,18-0,36
HFM4-08-2R	8	2	8	7,61	4	12	76	6,0	0,32	0,18-0,36
HFM5-10-2R	10	2	10	9,61	4,3	15	100	7,5	0,4	0,22-0,44
HFM5-12-2R	12	2	12	11,61	4,6	18	100	9,0	0,48	0,27-0,54
HFM5-16-2R	16	2	16	15	5	18	100	12,0	0,52	0,30-0,60

Solid Carbide End Mill Program - High Feed continued

HFM Cutting Conditions											
Work Material USA/W.-Nr./JIS	Material Hardness Hrc	Cutting Depth at Diameter ap max								Cutting Width Ae max	Coating type recommended
		2	3	4	5	6	8	10	12		
H13/1.2344/SKD61	<41	0,09	0,12	0,15	0,2	0,24	0,32	0,4	0,48	75%	HSN
H13/1.2344/SKD61	41-50	0,09	0,12	0,15	0,2	0,24	0,32	0,4	0,48	75%	HSN
H13/1.2344/SKD61	51+	0,08	0,1	0,12	0,18	0,2	0,3	0,3	0,4	75%	HSN
A2/1,2363/SKD12	<41	0,09	0,12	0,15	0,2	0,24	0,32	0,4	0,48	75%	HSN
A2/1,2363/SKD12	41-50	0,09	0,12	0,15	0,2	0,24	0,32	0,4	0,48	75%	HSN
A2/1,2363/SKD12	51+	0,08	0,1	0,12	0,18	0,2	0,3	0,3	0,4	75%	HSN
P20/1,2330	<41	0,09	0,12	0,15	0,2	0,24	0,32	0,4	0,48	75%	HSN
P20/1,2330	41-50	0,09	0,12	0,15	0,2	0,24	0,32	0,4	0,48	75%	HSN
D2/1,2379/SKD11	<41	0,09	0,12	0,15	0,2	0,24	0,32	0,4	0,48	75%	HSN
D2/1,2379/SKD11	41-50	0,09	0,12	0,15	0,2	0,24	0,32	0,4	0,48	75%	HSN
D2/1,2379/SKD11	51+	0,08	0,1	0,12	0,2	0,24	0,32	0,3	0,4	75%	HSN
Grey Cast Iron/GG	<41	0,09	0,12	0,15	0,2	0,24	0,32	0,4	0,48	75%	HSN
Cast Iron/GGG	41+	0,09	0,12	0,15	0,2	0,24	0,32	0,4	0,48	75%	HSN
Titanium (6AL 4V)		0,09	0,12	0,15	0,2	0,24	0,32	0,4	0,48	75%	HSN

Work Material USA/W.-Nr./JIS	Cut speed at D m/minute	Max feed per tooth fz at cutting insert dia D							
		2	3	4	5	6	8	10	12
H13/1,2344/SKD61	244-365	0,03-0,05	0,07-0,14	0,10-0,2	0,12-0,24	0,14-0,28	0,18-0,36	0,22-0,44	0,27-0,54
H13/1.2344/SKD61	183-244	0,03-0,05	0,07-0,14	0,10-0,2	0,12-0,24	0,14-0,28	0,18-0,36	0,22-0,44	0,27-0,54
H13/1.2344/SKD61	90-150	0,03-0,05	0,07-0,14	0,10-0,2	0,12-0,24	0,14-0,28	0,18-0,36	0,22-0,44	0,27-0,54
A2/1,2363/SKD12	244-365	0,03-0,05	0,07-0,14	0,10-0,2	0,12-0,24	0,14-0,28	0,18-0,36	0,22-0,44	0,27-0,54
A2/1,2363/SKD12	183-244	0,03-0,05	0,07-0,14	0,10-0,2	0,12-0,24	0,14-0,28	0,18-0,36	0,22-0,44	0,27-0,54
A2/1,2363/SKD12	90-150	0,03-0,05	0,07-0,14	0,10-0,2	0,12-0,24	0,14-0,28	0,18-0,36	0,22-0,44	0,27-0,54
P20/1,2330	244-365	0,03-0,05	0,07-0,14	0,10-0,2	0,12-0,24	0,14-0,28	0,18-0,36	0,22-0,44	0,27-0,54
P20/1,2330	183-244	0,03-0,05	0,07-0,14	0,10-0,2	0,12-0,24	0,14-0,28	0,18-0,36	0,22-0,44	0,27-0,54
D2/1,2379/SKD11	183-244	0,03-0,05	0,07-0,14	0,10-0,2	0,12-0,24	0,14-0,28	0,18-0,36	0,22-0,44	0,27-0,54
D2/1,2379/SKD11	105-140	0,03-0,05	0,07-0,14	0,10-0,2	0,12-0,24	0,14-0,28	0,18-0,36	0,22-0,44	0,27-0,54
D2/1,2379/SKD11	80-140	0,03-0,05	0,07-0,14	0,10-0,2	0,12-0,24	0,14-0,28	0,18-0,36	0,22-0,44	0,27-0,54
Grey Cast Iron/GG	350-900	0,03-0,05	0,07-0,14	0,10-0,2	0,12-0,24	0,14-0,28	0,18-0,36	0,22-0,44	0,27-0,54
Cast Iron/GGG	250-400	0,03-0,05	0,07-0,14	0,10-0,2	0,12-0,24	0,14-0,28	0,18-0,36	0,22-0,44	0,27-0,54
Titanium (6AL 4V)	120-180	0,03-0,05	0,07-0,14	0,10-0,2	0,12-0,24	0,14-0,28	0,18-0,36	0,22-0,44	0,27-0,54

Solid Carbide End Mill Program - High Feed continued



Quad Force

Tool Ordering No.	Cutter Diameter (D1) Tol. +0/-0.0006	Programmable Radius (R1)	Shank Diameter (D2)	Cutting Length (L1)	Total Length (L2)
QFM-04-HSN	4mm	0,57	4mm	14mm	51mm
QFM-06-HSN	6mm	0,80	6mm	20mm	63mm
QFM-08-HSN	8mm	1,10	8mm	20mm	63mm
QFM-10-HSN	10mm	3,30	10mm	25mm	70mm
QFM-12-HSN	12mm	4,20	12mm	29mm	76mm
QFM-16-HSN	16mm	5	16mm	37mm	89mm

Quad Force
M A C H I N I N G

Quad Force Application Data

Side/Slot Milling		High Feed Machining		Trochoidal		Plunge Milling	
Tool	QFM-10-HSN	Tool	QFM-10-HSN	Tool	QFM-10-HSN	Tool	QFM-10-HSN
Tool Diameter	10mm	Tool Diameter	10mm	Tool Diameter	10mm	Tool Diameter	10mm
Spindle Speed	6265 RPM	Spindle Speed	6265 RPM	Spindle Speed	6265 RPM	Spindle Speed	6265 RPM
Feed Rate	5700	Feed Rate	5700	Feed Rate	5700	Feed Rate	5700
Depth of Cut	20mm	Depth of Cut	0.3mm	Depth of Cut	20mm	Depth of Cut	0 - 20mm
Width of Cut	0.3mm	Width of Cut	6mm	Width of Cut	0.3mm	Width of Cut	0.3mm
Metal Removal Rate	34.2	Metal Removal Rate	10.26	Metal Removal Rate	34.2	Metal Removal Rate	34.2
Material	P20	Material	P20	Material	P20	Material	P20



Solid Carbide End Mill Program - Square Nose

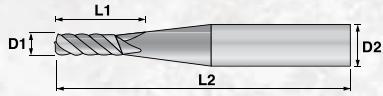

EMS - Square End

Tool Ordering No.	Cutter Diameter (D1) tol. +0/-0.01	Corner Radius	Shank Diameter (D2)	No. of Flutes	Neck Diameter	Cutting Length (L1)	Nose Taper	Overall Length (L2)
EMS-0.5	0,5	-	6	3	0,5	1,5	7.5° / side	63
EMS-1.0	1	-	6	4	1	3	7.5° / side	63
EMS-1.5	1,5	-	6	4	1,5	4,5	7.5° / side	63
EMS-2.0	2	-	6	4	2,0	6	7.5° / side	63
EMS-3.0	3	-	6	5	3,0	9	7.5° / side	75
EMS-4.0	4	-	6	6	4,0	12	7.5° / side	75
EMS-5.0	5	-	6	6	5	15	-	75
EMS-6.0	6	-	6	6	6	18	-	75
EMS-8.0	8	-	8	6	8	24	-	90
EMS-10.0	10	-	10	6	10	30	-	100
EMS-12.0	12	-	12	6	12	36	-	100
EMS-16.0	16	-	16	6	16	48	-	100

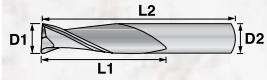

EMS2 - 2 Flute Endmill, Square End

Tool Ordering No.	Cutter Diameter (D1) tol. +0/-0.015	Corner Radius (R1)	Shank Diameter (D1)	Cutting Length (L1)	Total Length (L2)
EMS2-01-	1*	XX	3,000	4	38
EMS2-02-	2*	XX	3,000	8	38
EMS2-03-	3	XX	3,000	12	38
EMS2-04-	4	XX	4,000	14	50
EMS2-06-	6	XX	6,000	19	63
EMS2-08-	8	XX	8,000	22	63
EMS2-10-	10	XX	10,000	25	63
EMS2-12-	12	XX	12,000	25	76
EMS2-16-	16	XX	16,000	38	92
EMS2-20-	20	XX	20,000	38	101

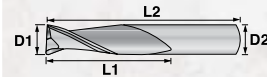

EMS2...LL - 2 Flute Long Series Endmill, Sq. End

Tool Ordering No.	Cutter Diameter (D1) tol. +0/-0.015	Corner Radius (R1)	Shank Diameter (D2)	Cutting Length (L1)	Total Length (L2)
EMS2-03-LL-	3	XX	3	16	50
EMS2-04-LL-	4	XX	4	20	76
EMS2-06-LL-	6	XX	6	25	76
EMS2-08-LL-	8	XX	8	25	76
EMS2-10-LL-	10	XX	10	25	101
EMS2-12-LL-	12	XX	12	25	101
EMS2-16-LL-	16	XX	16	50	152
EMS2-20-LL-	20	XX	20	50	152

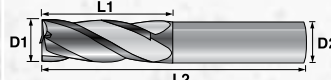

EMS4 - 4 Flute Endmill, Square End

Tool Ordering No.	Cutter Diameter (D1) tol. +0/-0.015	Corner Radius (R1)	Shank Diameter (D2)	Cutting Length (L1)	Total Length (L2)
EMS4-03-	3	XX	3,000	12	38
EMS4-04-	4	XX	4,000	14	50
EMS4-06-	6	XX	6,000	19	63
EMS4-08-	8	XX	8,000	22	63
EMS4-10-	10	XX	10,000	25	63
EMS4-12-	12	XX	12,000	25	76
EMS4-16-	16	XX	16,000	38	92
EMS4-20-	20	XX	20,000	38	101

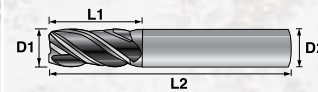

EMS4...LL - 4 Flute Long Series Endmill, Sq. End

Tool Ordering No.	Cutter Diameter (D1) tol. +0/-0.015	Corner Radius (R1)	Shank Diameter (D2)	Cutting Length (L1)	Total Length (L2)
EMS4-03-LL-	3	XX	3	16	50
EMS4-04-LL-	4	XX	4	20	76
EMS4-06-LL-	6	XX	6	25	76
EMS4-08-LL-	8	XX	8	25	76
EMS4-10-LL-	10	XX	10	25	101
EMS4-12-LL-	12	XX	12	25	101
EMS4-16-LL-	16	XX	16	50	152
EMS4-20-LL-	20	XX	20	50	152

Solid Carbide End Mill Program - Square Nose continued

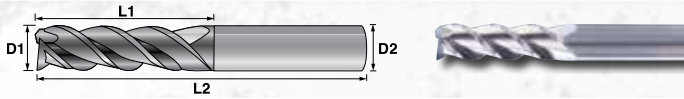

AlumiSTAR EMSA - 3 Flute Endmill, 45° - Aluminum

Tool Ordering No.	Cutter Diameter (D1) tol. +0/-0.015	Corner Radius (R1)	Shank Diameter (D2)	Cutting Length (L1)	Total Length (L2)
EMSA-04-	4	XX	4,000	14	50
EMSA-06-	6	XX	6,000	19	63
EMSA-08-	8	XX	8,000	22	63
EMSA-10-	10	XX	10,000	25	63
EMSA-12-	12	XX	12,000	25	76
EMSA-16-	16	XX	16,000	38	92
EMSA-20-	20	XX	20,000	38	101



EMV4 - 4 Flute Variable Fluted Endmill, Square End w/45° Chamfer

Tool Ordering No.	Cutter Diameter (D1) tol. +0/-0.015	Corner Radius (R1)	Shank Diameter (D2)	Cutting Length (L1)	Total Length (L2)
EMV4-03-	3	XX	3	16	38
EMV4-04-	4	XX	4	20	50
EMV4-06-	6	XX	6	25	63
EMV4-08-	8	XX	8	25	63
EMV4-10-	10	XX	10	25	63
EMV4-12-	12	XX	12	25	76
EMV4-16-	16	XX	16	50	92
EMV4-20-	20	XX	20	50	101

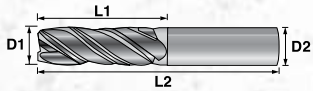

EMV5 - 5 Flute Variable Flute, Variable Helix Endmill, Square End

Tool Ordering No.	Cutter Dia. (D1) tol. +0/-0.001	Corner Radius (R1)	No. of Flutes	Shank Dia. (D2)	Cutting Length (L1)	Total Length (L2)
EMV5-3.0-HSN	3,0	XX	5	3,0	7,5	38
EMV5-4.0-HSN	4,0	XX	5	4,0	10,0	50
EMV5-6.0-HSN	6,0	XX	5	6,0	15,0	63
EMV5-8.0-HSN	8,0	XX	5	8,0	20,0	63
EMV5-10.0-HSN	10,0	XX	5	10,0	25,0	63
EMV5-12.0-HSN	12,0	XX	5	12,0	30,0	76
EMV5-16.0-HSN	16,0	XX	5	16,0	40,0	100

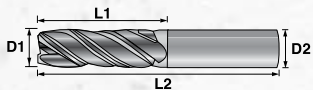

EMV5 - 5 Flute Variable Flute, Variable Helix Endmill, With Corner Radius

Tool Ordering No.	Cutter Dia. (D1) tol. +0/-0.001	Corner Radius (R1)	No. of Flutes	Shank Dia. (D2)	Cutting Length (L1)	Total Length (L2)
EMV5-3.0-0.5-HSN	3,0	0,5	5	3,0	7,5	38
EMV5-4.0-0.5-HSN	4,0	0,5	5	4,0	10,0	50
EMV5-6.0-0.5-HSN	6,0	0,5	5	6,0	15,0	63
EMV5-6.0-1.0-HSN	6,0	1,0	5	6,0	15,0	63
EMV5-8.0-0.5-HSN	8,0	0,5	5	8,0	20,0	63
EMV5-8.0-1.0-HSN	8,0	1,0	5	8,0	20,0	63
EMV5-10.0-0.5-HSN	10,0	0,5	5	10,0	25,0	63
EMV5-10.0-1.0-HSN	10,0	1,0	5	10,0	25,0	63
EMV5-12.0-0.5-HSN	12,0	0,5	5	12,0	30,0	76
EMV5-12.0-1.0-HSN	12,0	1,0	5	12,0	30,0	76
EMV5-16.0-0.5-HSN	16,0	0,5	5	16,0	40,0	100
EMV5-16.0-1.0-HSN	16,0	1,0	5	16,0	40,0	100

Solid Carbide End Mill Program - Ball Nose

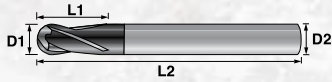

BM - Ball Nose

Tool Ordering No.	Cutter Diameter (D1) tol. +0/-0.01	Ball Radius	Shank Diameter (D2)	No. of Flutes	Neck Diameter	Cutting Length (L1)	Nose Taper	Overall Length (L2)
BM-0.5	0,5	0,25	6	2	-	0,5	7,5° / side	63
BM-0.6	0,6	0,30	6	2	-	0,6	7,5° / side	63
BM-0.8	0,8	0,40	6	2	-	0,8	7,5° / side	63
BM-1.0	1	0,50	6	2	-	1,0	7,5° / side	63
BM-1.5	1,5	0,75	6	2	-	1,5	7,5° / side	63
BM-2.0	2	1,00	6	2	-	2,0	7,5° / side	63
BM-3.0	3	1,50	6	2	-	3,0	7,5° / side	75
BM-4.0	4	2,00	6	2	-	4,0	7,5° / side	75
BM-5.0	5	2,50	6	2	-	5,0	7,5° / side	75
BM-6.0	6	3,00	6	2	-	6,0	-	75
BM-6.0-LL	6	3,00	6	2	-	6,0	-	100
BM-8.0	8	4,00	8	2	-	8,0	-	90
BM-8.0-LL	8	4,00	8	2	-	8,0	-	110
BM-10.0	10	5,00	10	2	-	10,0	-	100
BM-10.0-LL	10	5,00	10	2	-	10,0	-	120
BM-12.0	12	6,00	12	2	-	12,0	-	100
BM-12.0-LL	12	6,00	12	2	-	12,0	-	120
BM-16.0	16	8,00	16	2	-	16,0	-	100
BM-16.0-LL	16	8,00	16	2	-	16,0	-	150

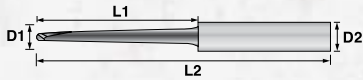

BM - Ball Nose w/.75° Taper Neck HSN Coated

Tool Ordering No.	Cutter Diameter (D1) tol. +0/-0.01	Corner Radius	Shank Diameter (D2)	No. of Flutes	Neck Taper Angle per Side	Cutting Length (L1)	Neck Taper Length	Overall Length (L2)
BM-2.0-HSN-16NL	2	1	6	2	0,75°	2	16	50
BM-2.0-HSN-21NL	2	1	6	2	0,75°	2	21	50
BM-2.0-HSN-26NL	2	1	6	2	0,75°	2	26	50
BM-2.0-HSN-31.75NL	2	1	6	2	0,75°	2	31,75	50
BM-2.4-HSN-16NL	2,4	1,2	6	2	0,75°	2,4	16	50
BM-2.4-HSN-21NL	2,4	1,2	6	2	0,75°	2,4	21	50
BM-2.4-HSN-26NL	2,4	1,2	6	2	0,75°	2,4	26	50
BM-2.4-HSN-31.75NL	2,4	1,2	6	2	0,75°	2,4	31,75	60

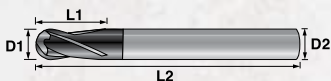

BMS-LL - Z2 Angle 30°

Tool Ordering No.	Cutter Diameter (D1) tol. +0/-0.01	Corner Radius	Shank Diameter (D2)	No. of Flutes	Cutting Length (L1)	Overall Length (L2)
BMS-2.0-LL	2,0	1,0	6	2	4,0	75
BMS-3.0-LL	3,0	1,5	6	2	5,0	75
BMS-4.0-LL	4,0	2,0	6	2	6,0	75
BMS-5.0-LL	5,0	2,5	6	2	8,0	75
BMS-6.0-LL	6,0	3,0	6	2	10,0	75
BMS-8.0-LL	8,0	4,0	8	2	12,0	90
BMS-10.0-LL	10,0	5,0	10	2	16,0	120
BMS-12.0-LL	12,0	6,0	12	2	18,0	120

All products on these pages come in both TLN and HSN coatings.

Examples:

BM-0.5-TLN

BMS-12.0-LL-HSN

Solid Carbide End Mill Program - Ball Nose continued

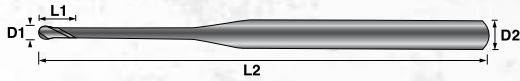

BMT

Tool Ordering No.	Cutter Diameter (D1) tol. +0 /-0.0004	Effective Length	Shank Diameter (D2)	Neck Diameter	Cutting Length (L1)	Overall Length (L2)
BMT-0,5-HSN-3NL	0,5	3	4	0,47	0,4	50
BMT-0,5-HSN-6NL	0,5	6	4	0,47	0,4	50
BMT-0,5-HSN-8NL	0,5	8	4	0,47	0,4	50
BMT-1,0-HSN-4NL	1	4	4	0,95	0,8	50
BMT-1,0-HSN-6NL	1	6	4	0,95	0,8	50
BMT-1,0-HSN-8NL	1	8	4	0,95	0,8	50
BMT-1,0-HSN-10NL	1	10	4	0,95	0,8	50
BMT-1,0-HSN-12NL	1	12	4	0,95	0,8	50
BMT-1,0-HSN-16NL	1	16	4	0,95	0,8	50
BMT-1,5-HSN-4NL	1,5	4	4	1,44	1,2	50
BMT-1,5-HSN-6NL	1,5	6	4	1,44	1,2	50
BMT-1,5-HSN-8NL	1,5	8	4	1,44	1,2	50
BMT-1,5-HSN-10NL	1,5	10	4	1,44	1,2	50
BMT-1,5-HSN-12NL	1,5	12	4	1,44	1,2	50
BMT-1,5-HSN-16NL	1,5	16	4	1,44	1,2	50
BMT-1,5-HSN-20NL	1,5	20	4	1,44	1,2	50
BMT-2,0-HSN-8NL	2	8	4	1,94	1,6	50
BMT-2,0-HSN-10NL	2	10	4	1,94	1,6	50
BMT-2,0-HSN-12NL	2	12	4	1,94	1,6	50
BMT-2,0-HSN-16NL	2	16	4	1,94	1,6	50
BMT-2,0-HSN-20NL	2	20	4	1,94	1,6	50
BMT-2,0-HSN-25NL	2	25	4	1,94	1,6	50
BMT-2,5-HSN-8NL	2,5	8	4	2,41	2	50
BMT-2,5-HSN-10NL	2,5	10	4	2,41	2	50
BMT-2,5-HSN-12NL	2,5	12	4	2,41	2	50
BMT-2,5-HSN-16NL	2,5	16	4	2,41	2	50
BMT-2,5-HSN-20NL	2,5	20	4	2,41	2	50
BMT-2,5-HSN-25NL	2,5	25	4	2,41	2	50
BMT-2,5-HSN-30NL	2,5	30	4	2,41	2	50
BMT-3,0-HSN-8NL	3	8	6	2,91	2,4	60
BMT-3,0-HSN-10NL	3	10	6	2,91	2,4	60
BMT-3,0-HSN-12NL	3	12	6	2,91	2,4	60
BMT-3,0-HSN-16NL	3	16	6	2,91	2,4	60
BMT-3,0-HSN-20NL	3	20	6	2,91	2,4	75
BMT-3,0-HSN-25NL	3	25	6	2,91	2,4	75
BMT-3,0-HSN-30NL	3	30	6	2,91	2,4	75
BMT-4,0-HSN-16NL	4	15	6	3,91	3,0	75
BMT-4,0-HSN-20NL	4	20	6	3,91	3,0	75
BMT-4,0-HSN-25NL	4	25	6	3,91	3,0	75
BMT-4,0-HSN-30NL	4	30	6	3,91	3,0	75
BMT-4,0-HSN-35NL	4	35	6	3,91	3,0	80

Solid Carbide End Mill Program - Ball Nose continued

Cutting Conditions Data - BMT

Work Piece Material			Carbon Steels, Alloy Steels, (180-250HB) Copper(Cu): N+20% / fz+20%					Tool Steels (25-35HRC)				
Mill Dia. mm	Radius	Neck Length	doc mm	woc mm	N rpm	fz mm/tooth	Vf mm/min	doc mm	woc mm	N rpm	fz mm/tooth	Vf mm/min
0,5	0,25	4	0,02	0,06	50,000	0,011	1,100	0,018	0,054	50,000	0,001	990
0,5	0,25	6	0,013	0,039	50,000	0,011	1,100	0,012	0,035	40,000	0,001	790
1	0,5	3	0,1	0,3	38,000	0,022	1,670	0,09	0,27	29,000	0,02	1,150
1	0,5	4	0,07	0,21	38,000	0,022	1,670	0,063	0,189	29,000	0,02	1,150
1	0,5	6	0,04	0,12	34,000	0,022	1,500	0,036	0,108	29,000	0,02	1,150
1	0,5	8	0,04	0,12	34,000	0,022	1,500	0,036	0,108	29,000	0,02	1,150
1	0,5	10	0,025	0,075	27,000	0,022	1,190	0,023	0,068	20,000	0,02	790
1	0,5	12	0,025	0,075	27,000	0,022	1,190	0,023	0,068	20,000	0,02	790
1	0,5	16	0,015	0,045	19,000	0,022	840	0,014	0,041	17,000	0,02	680
1	0,5	20	0,01	0,03	19,000	0,022	840	0,009	0,027	17,000	0,02	680
1,2	0,6	8	0,04	0,12	29,000	0,026	1,510	0,036	0,108	21,000	0,023	980
1,2	0,6	12	0,03	0,09	22,000	0,026	1,140	0,027	0,081	17,000	0,023	790
1,4	0,7	8	0,055	0,165	25,000	0,03	1,500	0,05	0,149	18,000	0,027	970
1,4	0,7	16	0,035	0,105	19,000	0,03	1,140	0,032	0,095	14,000	0,027	760
1,5	0,75	8	0,06	0,18	23,000	0,033	1,520	0,054	0,162	17,000	0,03	1,010
1,5	0,75	12	0,06	0,18	23,000	0,033	1,520	0,054	0,162	17,000	0,03	1,010
1,5	0,75	20	0,038	0,114	13,000	0,033	860	0,034	0,103	11,500	0,03	680
1,6	0,8	12	0,065	0,195	21,000	0,035	1,470	0,059	0,176	16,000	0,032	1,010
1,6	0,8	20	0,04	0,12	12,000	0,035	840	0,036	0,108	11,000	0,032	690
1,8	0,9	12	0,07	0,21	19,000	0,039	1,480	0,063	0,189	14,000	0,035	980
1,8	0,9	20	0,045	0,135	15,000	0,039	1,170	0,041	0,122	11,000	0,035	770
2	1	6	0,2	0,6	19,000	0,043	1,630	0,18	0,54	14,000	0,039	1,080
2	1	8	0,14	0,42	19,000	0,043	1,630	0,126	0,378	14,000	0,039	1,080
2	1	10	0,14	0,42	19,000	0,043	1,630	0,126	0,378	14,000	0,039	1,080
2	1	12	0,08	0,24	17,000	0,043	1,460	0,072	0,216	13,000	0,039	1,000
2	1	16	0,08	0,24	17,000	0,043	1,460	0,072	0,216	13,000	0,039	1,000
2	1	20	0,05	0,15	13,000	0,043	1,120	0,045	0,135	10,000	0,039	780
2	1	25	0,05	0,15	9,600	0,043	830	0,045	0,135	8,600	0,039	670
2	1	30	0,03	0,09	9,600	0,043	830	0,027	0,081	8,600	0,039	670
3	1,5	10	0,21	0,63	13,000	0,08	2,080	0,189	0,567	9,600	0,072	1,380
3	1,5	25	0,08	0,24	8,900	0,08	1,420	0,072	0,216	6,700	0,072	960
3	1,5	35	0,08	0,24	8,900	0,08	1,420	0,072	0,216	6,700	0,072	960
4	2	16	0,28	0,84	9,600	0,1	1,920	0,252	0,756	7,200	0,09	1,300
4	2	35	0,1	0,3	6,700	0,1	1,340	0,09	0,27	5,000	0,09	900
4	2	50	0,1	0,3	4,800	0,1	960	0,09	0,27	4,300	0,09	770
5	2,5	25	0,35	1,05	7,600	0,12	1,820	0,315	0,945	5,700	0,108	1,230
5	2,5	40	0,2	0,6	7,000	0,12	1,680	0,18	0,54	5,200	0,108	1,120
6	3	30	0,42	1,26	6,400	0,14	1,790	0,378	1,134	4,800	0,126	1,210
6	3	50	0,15	0,45	4,500	0,14	1,260	0,135	0,405	3,300	0,126	830

Solid Carbide End Mill Program - Ball Nose continued

Cutting Conditions Data - BMT

Work Piece Material			Tool Steels (35~45HRC)					Hardened Steels (45~55HRC)					Hardened Steels (55~70HRC)				
Mill Dia. mm	Radius	Neck Length	doc mm	woc mm	N rpm	fz mm/tooth	Vf mm/min	doc mm	woc mm	N rpm	fz mm/tooth	Vf mm/min	doc mm	woc mm	N rpm	fz mm/tooth	Vf mm/min
0,5	0,25	4	0,016	0,048	40,000	0,009	700	0,013	0,039	29,000	0,008	450	0,01	0,03	23,200	0,008	360
0,5	0,25	6	0,01	0,031	31,000	0,009	550	0,008	0,025	29,000	0,008	450	0,007	0,02	23,200	0,008	360
1	0,5	3	0,08	0,24	22,000	0,018	770	0,065	0,195	16,000	0,015	490	0,05	0,15	12,800	0,015	390
1	0,5	4	0,056	0,168	22,000	0,018	770	0,046	0,137	16,000	0,015	490	0,035	0,105	12,800	0,015	390
1	0,5	6	0,032	0,096	20,000	0,018	710	0,026	0,078	14,000	0,015	430	0,02	0,06	11,200	0,015	350
1	0,5	8	0,032	0,096	20,000	0,018	710	0,026	0,078	14,000	0,015	430	0,02	0,06	11,200	0,015	350
1	0,5	10	0,02	0,06	16,000	0,018	560	0,016	0,049	14,000	0,015	430	0,013	0,038	11,200	0,015	350
1	0,5	12	0,02	0,06	16,000	0,018	560	0,016	0,049	14,000	0,015	430	0,013	0,038	11,200	0,015	350
1	0,5	16	0,012	0,036	16,000	0,018	570	0,001	0,029	14,000	0,015	430	0,008	0,023	11,200	0,015	350
1	0,5	20	0,008	0,024	16,000	0,018	570	0,007	0,02	14,000	0,015	430	0,005	0,015	11,200	0,015	350
1,2	0,6	8	0,032	0,096	17,000	0,021	710	0,026	0,078	12,000	0,018	440	0,02	0,06	9,600	0,018	350
1,2	0,6	12	0,024	0,072	13,000	0,021	540	0,02	0,059	12,000	0,018	440	0,015	0,045	9,600	0,018	350
1,4	0,7	8	0,044	0,132	14,000	0,024	670	0,036	0,107	10,000	0,021	420	0,028	0,083	8,000	0,021	340
1,4	0,7	16	0,028	0,084	11,000	0,024	530	0,023	0,068	10,000	0,021	420	0,018	0,053	8,000	0,021	340
1,5	0,75	8	0,048	0,144	13,000	0,026	690	0,039	0,117	9,600	0,023	440	0,03	0,09	7,680	0,023	360
1,5	0,75	12	0,048	0,144	13,000	0,026	690	0,039	0,117	9,600	0,023	440	0,03	0,09	7,680	0,023	360
1,5	0,75	20	0,03	0,091	10,000	0,026	530	0,025	0,074	9,600	0,023	440	0,019	0,057	7,680	0,023	360
1,6	0,8	12	0,052	0,156	13,000	0,028	730	0,042	0,127	9,000	0,025	440	0,033	0,098	7,200	0,025	350
1,6	0,8	20	0,032	0,096	10,000	0,028	560	0,026	0,078	9,000	0,025	440	0,02	0,06	7,200	0,025	350
1,8	0,9	12	0,056	0,168	11,000	0,031	690	0,046	0,137	8,000	0,027	440	0,035	0,105	6,400	0,027	350
1,8	0,9	20	0,036	0,108	8,700	0,031	540	0,029	0,088	8,000	0,027	440	0,023	0,068	6,400	0,027	350
2	1	6	0,16	0,48	11,000	0,034	750	0,13	0,39	8,000	0,03	480	0,1	0,3	6,400	0,03	380
2	1	8	0,112	0,336	11,000	0,034	750	0,091	0,273	8,000	0,03	480	0,07	0,21	6,400	0,03	380
2	1	10	0,112	0,336	11,000	0,034	750	0,091	0,273	8,000	0,03	480	0,07	0,21	6,400	0,03	380
2	1	12	0,064	0,192	10,000	0,034	690	0,052	0,156	7,200	0,03	430	0,04	0,12	5,760	0,03	350
2	1	16	0,064	0,192	10,000	0,034	690	0,052	0,156	7,200	0,03	430	0,04	0,12	5,760	0,03	350
2	1	20	0,04	0,12	7,800	0,034	540	0,033	0,098	7,200	0,03	430	0,025	0,075	5,760	0,03	350
2	1	25	0,04	0,12	7,800	0,035	540	0,033	0,098	7,200	0,03	440	0,025	0,075	5,760	0,03	350
2	1	30	0,024	0,072	7,800	0,035	540	0,02	0,059	7,200	0,03	440	0,015	0,045	5,760	0,03	350
3	1,5	10	0,168	0,504	7,400	0,064	950	0,137	0,41	5,300	0,056	590	0,105	0,315	4,240	0,056	470
3	1,5	25	0,064	0,192	5,200	0,064	660	0,052	0,156	4,800	0,056	540	0,04	0,12	3,840	0,056	430
3	1,5	35	0,064	0,192	5,200	0,064	660	0,052	0,156	4,800	0,056	540	0,04	0,12	3,840	0,056	430
4	2	16	0,224	0,672	5,600	0,08	900	0,182	0,546	4,000	0,07	560	0,14	0,42	3,200	0,07	450
4	2	35	0,08	0,24	3,900	0,08	620	0,065	0,195	3,600	0,07	500	0,05	0,15	2,880	0,07	400
4	2	50	0,08	0,24	3,900	0,08	620	0,065	0,195	3,600	0,07	500	0,05	0,15	2,880	0,07	400
5	2,5	25	0,28	0,84	4,500	0,096	860	0,228	0,683	3,200	0,084	540	0,175	0,525	2,560	0,084	430
5	2,5	40	0,16	0,48	4,000	0,096	770	0,13	0,39	2,900	0,084	490	0,1	0,3	2,320	0,084	390
6	3	30	0,336	1,008	3,700	0,112	830	0,273	0,819	2,700	0,098	530	0,21	0,63	2,160	0,098	420
6	3	50	0,12	0,36	2,600	0,112	580	0,098	0,293	2,400	0,098	470	0,075	0,225	1,920	0,098	380

Solid Carbide End Mill Program - Ball Nose continued

Extended Reach ball nose tools Series BMNL and extended reach square nose tools Series EMR are useful tools specifically designed for long reach milling of extrusion dies, deep cavities and cores, deep rib milling and similar applications. The reduced flute length and neck diameter assure constant cutting pressure and minimal tool deflection.

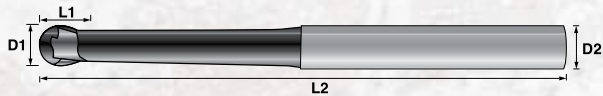

BMNL - Ball, Extended Reach Tapered Nose*

Tool Ordering No.	Cutter Diameter (D1) tol. +0 / -0.01	Corner Radius	Shank Diameter (D2)	No. of Flutes	Neck Diameter	Cutting Length (L1)	Nose Taper	Overall Length (L2)
BM-2.0-1.25NL	2	1	6	2	1,9 / 1,3	2	31,75 / (1,25")	75
BM-2.0-1.80NL	2	1	6	2	1,9 / 1,3	2	45,70 / (1,8")	75
BM-2.5-1.25NL	2,5	1,25	6	2	2,4 / 1,3	2,5	31,75 / (1,25")	75
BM-2.5-1.80NL	2,5	1,25	6	2	2,4 / 1,3	2,5	45,70 / (1,8")	75
BM-3.0-1.25NL	3	1,5	6	2	2,9 / 1,3	3	31,75 / (1,25")	75
BM-3.0-1.50NL	3	1,5	6	2	2,9 / 1,3	3	38,1 / (1,5")	75
BM-3.0-1.80NL	3	1,5	6	2	2,9 / 1,3	3	45,70 / (1,8")	75
BM-3.0-50NL	3	1,5	6	2	2,9 / 1,3	3	50 / (1,95")	75
BM-4.0-1.25NL	4	2	6	2	3,9 / 1,3	4	31,75 / (1,25")	75
BM-4.0-1.80NL	4	2	6	2	3,9 / 1,3	4	45,70 / (1,8")	75
BM-4.0-50NL	4	2	6	2	3,9 / 1,3	4	50 / (1,95")	75
BM-5.0-1.25NL	5	2,5	6	2	4,9 / 1,3	5	31,75 / (1,25")	75
BM-5.0-1.80NL	5	2,5	6	2	4,9 / 1,3	5	45,70 / (1,8")	75
BM-6.0-1.25NL	6	3	6	2	5,9 / -	6	31,75 / (1,25")	75
BM-6.0-1.50NL	6	3	6	2	5,9 / -	6	38,1 / (1,5")	75
BM-6.0-1.80NL	6	3	6	2	5,9 / -	6	45,70 / (1,8")	75
BM-8.0-1.25NL	8	4	8	2	7,9 / -	8	31,75 / (1,25")	75

* 1.3° Neck Taper Per Side

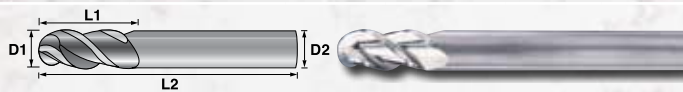

AlumiSTAR BMA - 3 Flute Endmill, Ballnose 45° - Aluminum

Tool Ordering No.	Cutter Diameter (D1) tol. +0 / -0.015	Corner Radius (R1)	Shank Diameter (D2)	Cutting Length (L1)	Total Length (L2)
BMA-03-	3	1,5	3,000	12	38
BMA-04-	4	2	4,000	14	50
BMA-06-	6	3	6,000	19	63
BMA-08-	8	4	8,000	22	63
BMA-10-	10	5	10,000	25	63
BMA-12-	12	6	12,000	25	76
BMA-16-	16	8	16,000	38	92
BMA-20-	20	10	20,000	38	101



BM2 - 2 Flute Long Series Endmill, Ballnose

Tool Ordering No.	Cutter Diameter (D1) tol. +0 / -0.015	Corner Radius (R1)	Shank Diameter (D2)	Cutting Length (L1)	Total Length (L2)
BM2-03-LL-	3	1,5	3	16	50
BM2-04-LL-	4	2	4	20	76
BM2-06-LL-	6	3	6	25	76
BM2-08-LL-	8	4	8	25	76
BM2-10-LL-	10	5	10	25	101
BM2-12-LL-	12	6	12	25	101
BM2-16-LL-	16	8	16	50	152
BM2-20-LL-	20	10	20	50	152

All products on these pages come in both TLN and HSN coatings.

Solid Carbide End Mill Program - Ball Nose continued

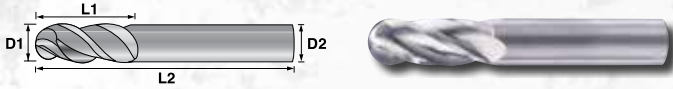

BM4 - 4 Flute Endmill Long Series, Ballnose

Tool Ordering No.	Cutter Diameter (D1) tol. +0 / -0.015	Corner Radius (R1)	Shank Diameter (D2)	Cutting Length (L1)	Total Length (L2)
BM4-03-LL-	3	1,5	3	16	50
BM4-04-LL-	4	2	4	20	76
BM4-06-LL-	6	3	6	25	76
BM4-08-LL-	8	4	8	25	76
BM4-10-LL-	10	5	10	25	101
BM4-12-LL-	12	6	12	25	101
BM4-16-LL-	16	8	16	50	152
BM4-20-LL-	20	10	20	50	152

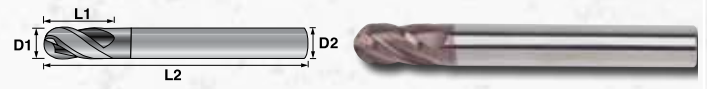

BM4T - Ballnose, Special Tip Design for HSM

Tool Ordering No.	Cutter Diameter (D1) tol. +0 / -0.0004	Shank Diameter (D2)	Cutting Length (L1)	Overall Length (L2)
BM4T-3.0	3	6	6	75
BM4T-4.0	4	6	8	75
BM4T-6.0	6	6	12	75
BM4T-8.0	8	8	16	90
BM4T-10.0	10	10	20	100
BM4T-12.0	12	12	24	100



BM220 - 220° 2 Flute Endmill, Ballnose

Tool Ordering No.	Cutter Diameter (D1) tol. +0 / -0.015	Corner Radius (R1)	Shank Diameter (D2)	Cutting Length (L1)	Total Length (L2)
BM220-03-	3	1,5	3	2,25	38
BM220-04-	4	2	4	3,00	50
BM220-06-	6	3	6	4,50	63
BM220-08-	8	4	8	6,00	63
BM220-10-	10	5	10	7,50	63
BM220-12-	12	6	12	9,00	76

All products on these pages come in both TLN and HSN coatings.

Solid Carbide End Mill Program - Bull Nose

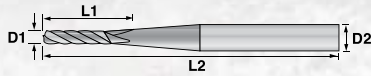

EMB - Bull Nose w/Corner Radius

Tool Ordering No.	Cutter Diameter (D1) tol. +0/-0.01	Corner Radius	Shank Diameter (D2)	No. of Flutes	Neck Diameter	Cutting Length (L1)	Nose Taper	Overall Length (L2)
EMB-1.0-0.2	1	0,2	6	4	1	3	7.5° / side	63
EMB-1.5-0.2	1,5	0,2	6	4	1,5	4,5	7.5° / side	63
EMB-2.0-0.2	2	0,2	6	4	2	6	7.5° / side	63
EMB-3.0-0.3	3	0,3	6	5	3	9	7.5° / side	75
EMB-4.0-0.5	4	0,5	6	6	4	12	7.5° / side	75
EMB-5.0-0.5	5	0,5	6	6	5	15	7.5° / side	75
EMB-6.0-0.5	6	0,5	6	6	6	18	-	75
EMB-6.0-1.0	6	1,0	6	6	6	18	-	75
EMB-8.0-0.5	8	0,5	8	6	8	24	-	90
EMB-8.0-1.0	8	1,0	8	6	8	24	-	90
EMB-10.0-1.0	10	1,0	10	6	10	30	-	100
EMB-12.0-1.0	12	1,08	12	6	12	36	-	100

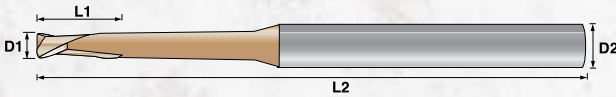

EMB - Bull Nose - End Mill w/.75° Taper Neck HSN Coated

Tool Ordering No.	Cutter Diameter (D1) tol. +0/-0.01	Corner Radius	Shank Diameter (D2)	No. of Flutes	Neck Taper Angle per Side	Cutting Length (L1)	Neck Taper Length	Overall Length (L2)
EMB-2.4-0.5-HSN-12NL	2.4	0.5	4	2	0,75°	2,4	12	50
EMB-2.4-0.5-HSN-16NL	2.4	0.5	4	2	0,75°	2,4	16	50
EMB-2.4-0.5-HSN-20NL	2.4	0.5	4	2	0,75°	2,4	20	50
EMB-2.4-0.5-HSN-25NL	2.4	0.5	6	2	0,75°	2,4	25	50
EMB-3.0-0.5-HSN-12NL	3	0.5	6	2	0,75°	3	12	50
EMB-3.0-0.5-HSN-16NL	3	0.5	6	2	0,75°	3	16	50
EMB-3.0-0.5-HSN-20NL	3	0.5	6	2	0,75°	3	20	50
EMB-3.0-0.5-HSN-25NL	3	0.5	6	2	0,75°	3	25	50
EMB-4.0-0.5-HSN-12NL	4	0.5	6	2	0,75°	4	12	50
EMB-4.0-0.5-HSN-16NL	4	0.5	6	2	0,75°	4	16	50
EMB-4.0-0.5-HSN-20NL	4	0.5	6	2	0,75°	4	20	50
EMB-4.0-0.5-HSN-25NL	4	0.5	6	2	0,75°	4	25	50

All products on these pages come in both TLN and HSN coatings.

Solid Carbide End Mill Program - Bull Nose continued

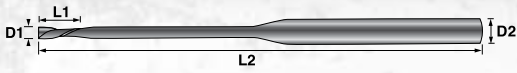

EMBT

Tool Ordering No.	Cutter Diameter (D1) tol. +0/-0.0004	Effective Length	Shank Diameter (D2)	Neck Diameter	Cutting Length (L1)	Overall Length (L2)
EMBT-1,0-0,1-HSN-4NL	1	4	4	0,95	0,8	50
EMBT-1,0-0,1-HSN-6NL	1	6	4	0,95	0,8	50
EMBT-1,0-0,1-HSN-8NL	1	8	4	0,95	0,8	50
EMBT-1,0-0,1-HSN-10NL	1	10	4	0,95	0,8	50
EMBT-1,0-0,1-HSN-12NL	1	12	4	0,95	0,8	50
EMBT-1,5-0,2-HSN-4NL	1,5	4	4	1,45	1,2	50
EMBT-1,5-0,2-HSN-6NL	1,5	6	4	1,45	1,2	50
EMBT-1,5-0,2-HSN-8NL	1,5	8	4	1,45	1,2	50
EMBT-1,5-0,2-HSN-10NL	1,5	10	4	1,45	1,2	50
EMBT-1,5-0,2-HSN-12NL	1,5	12	4	1,45	1,2	50
EMBT-2,0-0,2-HSN-6NL	2	6	4	1,92	1,6	50
EMBT-2,0-0,2-HSN-8NL	2	8	4	1,92	1,6	50
EMBT-2,0-0,2-HSN-10NL	2	10	4	1,92	1,6	50
EMBT-2,0-0,2-HSN-12NL	2	12	4	1,92	1,6	50
EMBT-2,0-0,2-HSN-16NL	2	16	4	1,92	1,6	50
EMBT-2,0-0,2-HSN-20NL	2	20	4	1,92	1,6	50
EMBT-2,5-0,2-HSN-6NL	2,5	6	4	2,42	2	50
EMBT-2,5-0,2-HSN-8NL	2,5	8	4	2,42	2	50
EMBT-2,5-0,2-HSN-10NL	2,5	10	4	2,42	2	50
EMBT-2,5-0,2-HSN-12NL	2,5	12	4	2,42	2	50
EMBT-2,5-0,2-HSN-16NL	2,5	16	4	2,42	2	50
EMBT-2,5-0,2-HSN-20NL	2,5	20	4	2,42	2	50
EMBT-2,5-0,2-HSN-25NL	2,5	25	4	2,42	2	50
EMBT-3,0-0,2-HSN-6NL	3	6	6	2,92	2,4	55
EMBT-3,0-0,2-HSN-8NL	3	8	6	2,92	2,4	55
EMBT-3,0-0,2-HSN-10NL	3	10	6	2,92	2,4	55
EMBT-3,0-0,2-HSN-12NL	3	12	6	2,92	2,4	55
EMBT-3,0-0,2-HSN-16NL	3	16	6	2,92	2,4	60
EMBT-3,0-0,2-HSN-20NL	3	20	6	2,92	2,4	60
EMBT-3,0-0,2-HSN-25NL	3	25	6	2,92	2,4	60
EMBT-3,0-0,2-HSN-30NL	3	30	6	2,92	2,4	75
EMBT-3,0-0,5-HSN-8NL	3	8	6	2,92	2,4	55
EMBT-3,0-0,5-HSN-10NL	3	10	6	2,92	2,4	55
EMBT-3,0-0,5-HSN-12NL	3	12	6	2,92	2,4	55
EMBT-3,0-0,5-HSN-16NL	3	16	6	2,92	2,4	60
EMBT-3,0-0,5-HSN-20NL	3	20	6	2,92	2,4	60
EMBT-3,0-0,5-HSN-25NL	3	25	6	2,92	2,4	60
EMBT-3,0-0,5-HSN-30NL	3	30	6	2,92	2,4	75
EMBT-4,0-0,5-HSN-8NL	4	8	6	3,82	3,2	70
EMBT-4,0-0,5-HSN-16NL	4	16	6	3,82	3,2	70
EMBT-4,0-0,5-HSN-24NL	4	24	6	3,82	3,2	70
EMBT-4,0-0,5-HSN-32NL	4	32	6	3,82	3,2	80

Solid Carbide End Mill Program - Bull Nose continued

Cutting Conditions Data - EMBT

Work Piece Material				(180-250HB) 100%			Hardness (25-35HRC) 90%			Hardness (35-45HRC) 80%			Hardness (45-55HRC) 65%			Hardness (55-65HRC) 60%		
Mill Dia. mm	Radius	Neck Length	doc mm	woc mm	N rpm	Vf mm	woc mm	N rpm	Vf mm	woc mm	N rpm	Vf mm	woc mm	N rpm	Vf mm	woc mm	N rpm	Vf mm
1,0	0,05	2	0,025	0,45	32,400	1,359	0,45	29,160	1,223	0,45	27,540	1,039	0,45	24,300	815	0,45	22,680	666
1,0	0,05	4	0,020	0,45	32,400	1,359	0,45	29,160	1,223	0,45	27,540	1,039	0,45	24,300	815	0,45	22,680	666
1,0	0,05	6	0,017	0,45	26,244	990	0,45	23,620	891	0,45	22,307	842	0,45	19,683	660	0,45	18,371	539
1,0	0,05	8	0,015	0,45	23,328	880	0,45	20,995	792	0,45	19,829	748	0,45	17,496	587	0,45	16,330	479
1,0	0,10	4	0,038	0,40	32,400	1,359	0,40	29,160	1,223	0,40	27,540	1,039	0,40	24,300	815	0,40	22,680	666
1,0	0,10	6	0,024	0,40	26,244	990	0,40	23,620	891	0,40	22,307	842	0,40	19,683	660	0,40	18,371	539
1,0	0,10	8	0,024	0,40	23,328	880	0,40	20,995	792	0,40	19,829	748	0,40	17,496	587	0,40	16,330	479
1,0	0,10	10	0,015	0,40	20,412	770	0,40	18,371	693	0,40	17,350	655	0,40	15,309	514	0,40	14,288	419
1,0	0,10	12	0,015	0,40	18,144	609	0,40	16,330	548	0,40	15,422	453	0,40	13,608	399	0,40	12,701	320
1,0	0,20	4	0,070	0,30	32,400	1,359	0,30	29,160	1,223	0,30	27,540	1,039	0,30	24,300	815	0,30	22,680	666
1,0	0,20	6	0,040	0,30	26,244	990	0,30	23,620	891	0,30	22,307	842	0,30	19,683	660	0,30	18,371	539
1,0	0,20	8	0,040	0,30	23,328	880	0,30	20,995	792	0,30	19,829	748	0,30	17,496	587	0,30	16,330	479
1,0	0,20	10	0,025	0,30	20,412	770	0,30	18,371	693	0,30	17,350	655	0,30	15,309	514	0,30	14,288	419
1,0	0,20	12	0,025	0,30	18,144	609	0,30	16,330	548	0,30	15,422	453	0,30	13,608	399	0,30	12,701	320
1,0	0,30	6	0,040	0,20	26,244	990	0,20	23,620	891	0,20	22,307	842	0,20	19,683	660	0,20	18,371	539
1,0	0,30	10	0,025	0,20	20,412	770	0,20	18,371	693	0,20	17,350	655	0,20	15,309	514	0,20	14,288	419
1,5	0,1	4	0,042	0,6	24,930	1,130	0,65	22,453	1,017	0,65	20,956	868	0,65	18,711	678	0,65	17,364	556
1,5	0,1	8	0,036	0,65	22,680	1,027	0,65	20,412	924	0,65	19,278	873	0,65	17,010	685	0,65	15,876	559
1,5	0,1	12	0,036	0,65	18,144	822	0,65	16,330	740	0,65	15,422	698	0,65	13,608	548	0,65	12,701	447
1,5	0,1	15	0,023	0,65	14,112	568	0,65	12,701	511	0,65	11,995	423	0,65	10,584	373	0,65	9,878	298
1,5	0,1	20	0,018	0,65	14,112	568	0,65	12,701	511	0,65	11,995	423	0,65	10,584	373	0,65	9,878	298
1,5	0,2	4	0,070	0,55	24,930	1,130	0,55	22,453	1,017	0,55	20,956	868	0,55	18,711	678	0,55	17,364	556
1,5	0,2	8	0,060	0,55	22,680	1,027	0,55	20,412	924	0,55	19,278	873	0,55	17,010	685	0,55	15,876	559
1,5	0,2	12	0,060	0,55	18,144	822	0,55	16,330	740	0,55	15,422	698	0,55	13,608	548	0,55	12,701	447
1,5	0,2	15	0,038	0,55	14,112	568	0,55	12,701	511	0,55	11,995	423	0,55	10,584	373	0,55	9,878	298
1,5	0,2	20	0,030	0,55	14,112	568	0,55	12,701	511	0,55	11,995	423	0,55	10,584	373	0,55	9,878	298
1,5	0,3	8	0,060	0,45	22,680	1,027	0,45	20,412	924	0,45	19,278	873	0,45	17,010	685	0,45	15,876	559
1,5	0,3	15	0,038	0,45	14,112	568	0,45	12,701	511	0,45	11,995	423	0,45	10,584	373	0,45	9,878	298
1,5	0,3	20	0,030	0,45	14,112	568	0,45	12,701	511	0,45	11,995	423	0,45	10,584	373	0,45	9,878	298
2,0	0,2	6	0,080	0,80	20,790	1,635	0,80	18,711	1,471	0,80	17,672	1,389	0,80	15,593	981	0,80	14,553	801
2,0	0,2	8	0,070	0,80	18,900	1,486	0,80	17,010	1,337	0,80	16,065	1,263	0,80	14,175	892	0,80	13,230	728
2,0	0,2	12	0,040	0,80	15,309	1,083	0,80	13,778	975	0,80	13,013	921	0,80	11,482	722	0,80	10,716	590
2,0	0,2	16	0,040	0,80	13,608	963	0,80	12,247	867	0,80	11,567	818	0,80	10,206	642	0,80	9,526	524
2,0	0,2	20	0,035	0,80	11,907	843	0,80	10,716	758	0,80	10,121	716	0,80	8,930	562	0,80	8,335	459
2,0	0,2	25	0,025	0,80	11,907	843	0,80	10,716	758	0,80	10,121	716	0,80	8,930	562	0,80	8,335	459
2,0	0,3	8	0,090	0,70	18,900	1,651	0,70	17,010	1,486	0,70	16,065	1,403	0,70	14,175	991	0,70	13,230	809
2,0	0,3	16	0,060	0,70	13,608	1,070	0,70	12,247	963	0,70	11,567	909	0,70	10,206	713	0,70	9,526	583
2,0	0,3	20	0,037	0,70	11,907	936	0,70	10,716	843	0,70	10,121	796	0,70	8,930	624	0,70	8,335	510
2,0	0,5	6	0,170	0,50	20,790	1,635	0,50	18,711	1,471	0,50	17,672	1,389	0,50	15,593	981	0,50	14,553	801
2,0	0,5	8	0,140	0,50	18,900	1,651	0,50	17,010	1,486	0,50	16,065	1,403	0,50	14,175	991	0,50	13,230	809
2,0	0,5	12	0,080	0,50	15,309	1,204	0,50	13,778	1,083	0,50	13,013	1,023	0,50	11,482	802	0,50	10,716	655
2,0	0,5	16	0,080	0,50	13,608	1,070	0,50	12,247	963	0,50	11,567	909	0,50	10,206	713	0,50	9,526	583

Metric Bull Nose : EMBT Cutting Conditions

Solid Carbide End Mill Program - Bull Nose continued

Cutting Conditions Data - EMBT

Work Piece Material			(180-250HB) 100%			Hardness (25-35HRC) 90%			Hardness (35-45HRC) 80%			Hardness (45-55HRC) 65%			Hardness (55-65HRC) 60%			
Mill Dia. mm	Radius	Neck Length	doc mm	woc mm	N rpm	Vf mm	woc mm	N rpm	Vf mm	woc mm	N rpm	Vf mm	woc mm	N rpm	Vf mm	woc mm	N rpm	Vf mm
2.0	0.5	20	0.050	0.50	11,907	936	0.50	10,716	843	0.50	10,121	796	0.50	8,930	624	0.50	8,335	510
2.0	0.5	25	0.050	0.50	11,907	936	0.50	10,716	843	0.50	10,121	796	0.50	8,930	624	0.50	8,335	510
2.0	0.8	8	0.200	0.20	18,900	1,651	0.20	17,010	1,486	0.20	16,065	1,403	0.20	14,175	991	0.20	13,230	809
2.0	0.8	16	0.100	0.20	13,608	1,070	0.20	12,247	963	0.20	11,567	909	0.20	10,206	713	0.20	9,526	583
2.0	0.8	20	0.060	0.20	11,907	936	0.20	10,716	843	0.20	10,121	796	0.20	8,930	624	0.20	8,335	510
3.0	0.2	8	0.090	1.30	14,400	1,415	1.30	12,960	1,274	1.30	12,240	1,203	1.30	10,800	849	1.30	10,080	693
3.0	0.2	12	0.070	1.30	14,400	1,415	1.30	12,960	1,274	1.30	12,240	1,203	1.30	10,800	849	1.30	10,080	693
3.0	0.2	16	0.050	1.30	14,400	1,415	1.30	12,960	1,274	1.30	12,240	1,203	1.30	10,800	849	1.30	10,080	693
3.0	0.2	20	0.050	1.30	11,664	1,146	1.30	10,498	1,032	1.30	9,914	974	1.30	8,748	764	1.30	8,165	624
3.0	0.2	30	0.040	1.30	9,072	1,146	1.30	8,165	1,032	1.30	7,711	974	1.30	6,804	764	1.30	6,350	624
3.0	0.2	35	0.035	1.30	9,072	1,146	1.30	8,165	1,032	1.30	7,711	974	1.30	6,804	764	1.30	6,350	624
3.0	0.3	8	0.130	1.20	14,400	1,572	1.20	12,960	1,415	1.20	12,240	1,337	1.20	10,800	943	1.20	10,080	771
3.0	0.3	16	0.075	1.20	14,400	1,572	1.20	12,960	1,415	1.20	12,240	1,337	1.20	10,800	943	1.20	10,080	771
3.0	0.3	20	0.075	1.20	11,664	1,274	1.20	10,498	1,146	1.20	9,914	1,083	1.20	8,748	849	1.20	8,165	693
3.0	0.3	30	0.060	1.20	9,072	1,274	1.20	8,165	1,146	1.20	7,711	1,083	1.20	6,804	849	1.20	6,350	693
3.0	0.5	8	0.180	1.00	14,400	1,572	1.00	12,960	1,415	1.00	12,240	1,337	1.00	10,800	943	1.00	10,080	771
3.0	0.5	12	0.130	1.00	14,400	1,572	1.00	12,960	1,415	1.00	12,240	1,337	1.00	10,800	943	1.00	10,080	771
3.0	0.5	16	0.100	1.00	14,400	1,572	1.00	12,960	1,415	1.00	12,240	1,337	1.00	10,800	943	1.00	10,080	771
3.0	0.5	20	0.100	1.00	11,664	1,274	1.00	10,498	1,146	1.00	9,914	1,083	1.00	8,748	849	1.00	8,165	693
3.0	0.5	30	0.080	1.00	9,072	1,274	1.00	8,165	1,146	1.00	7,711	1,083	1.00	6,804	849	1.00	6,350	693
3.0	0.5	35	0.065	1.00	9,072	1,274	1.00	8,165	1,146	1.00	7,711	1,083	1.00	6,804	849	1.00	6,350	693

Solid Carbide End Mill Program - Bull Nose continued

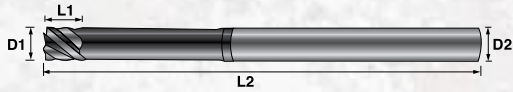

EMR - Bull Nose with Corner Radius, Extended Reach Tapered Nose*

Tool Ordering No.	Cutter Diameter (D1) tol. +0/-0.01	Corner Radius	Shank Diameter (D2)	No. of Flutes	Neck Diameter	Cutting Length (L1)	Nose Taper	Overall Length (L2)
EMR-2.0-0.2-1.25NL	2	0,2	6	4	1,9 / 1,3	2	31,75 / (1,25")	75
EMR-2.0-0.2-1.80NL	2	0,2	6	4	1,9 / 1,3	2	45,70 / (1,8")	75
EMR-2.0-0.2-50NL	2	0,2	6	4	1,9 / 1,3	2	50 / (1,95")	75
EMR-2.5-0.2-1.25NL	2,5	0,2	6	4	2,4 / 1,3	2,5	31,75 / (1,25")	75
EMR-2.5-0.2-1.80NL	2,5	0,2	6	4	2,4 / 1,3	2,5	45,70 / (1,8")	75
EMR-3.0-0.2-1.25NL	3	0,2	6	5	2,9 / 1,3	3	31,75 / (1,25")	75
EMR-3.0-0.2-1.80NL	3	0,2	6	5	2,9 / 1,3	3	45,70 / (1,8")	75
EMR-3.0-0.2-50NL	3	0,2	6	5	2,9 / 1,3	3	50 / (1,95")	75
EMR-4.0-0.2-1.25NL	4	0,2	6	6	3,9 / 1,3	4	31,75 / (1,25")	75
EMR-4.0-0.2-1.80NL	4	0,2	6	6	3,9 / 1,3	4	45,70 / (1,8")	75
EMR-4.0-0.2-50NL	4	0,2	6	6	3,9 / 1,3	4	50 / (1,95")	75
EMR-5.0-0.2-1.25NL	5	0,2	6	6	4,9 / 1,3	5	31,75 / (1,25")	75
EMR-5.0-0.2-1.80NL	5	0,2	6	6	4,9 / 1,3	5	45,70 / (1,8")	75
EMR-6.0-0.2-1.25NL	6	0,2	6	6	5,9 / -	6	31,75 / (1,25")	75
EMR-6.0-0.2-1.80NL	6	0,2	6	6	5,9 / -	6	45,70 / (1,8")	75
EMR-12.0-0.2-1.25NL	12	0,2	12	6	11,9 / -	12	31,75 / (1,25")	75
EMR-12.0-0.2-1.80NL	12	0,2	12	6	11,9 / -	12	45,70 / (1,8")	75

* 1.3° Neck Taper Per Side

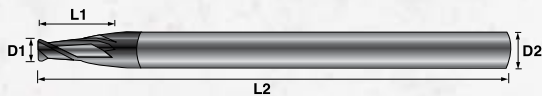

IMB-2.0 - Z2 Angle 30°

Tool Ordering No.	Cutter Diameter (D1) tol. +0/-0.01	Corner Radius	Shank Diameter (D2)	No. of Flutes	Cutting Length (L1)	Overall Length (L2)
IMB-2.0-0.5-EX2-LL	2,0	0,5	4	2	3,0	75
IMB-3.0-0.5-EX2-LL	3,0	0,5	6	2	4,5	75
IMB-3.0-1.0-EX2-LL	3,0	1,0	6	2	4,5	75
IMB-4.0-0.5-EX2-LL	4,0	0,5	6	2	6,0	75
IMB-4.0-1.0-EX2-LL	4,0	1,0	6	2	6,0	75
IMB-5.0-0.5-EX2-LL	5,0	0,5	6	2	7,5	75
IMB-5.0-1.0-EX2-LL	5,0	1,0	6	2	7,5	75
IMB-6.0-0.5-EX2-LL	6,0	0,5	6	2	9,0	90
IMB-6.0-1.0-EX2-LL	6,0	1,0	6	2	9,0	90
IMB-8.0-0.5-EX2-LL	8,0	0,5	8	2	12,0	100
IMB-8.0-1.0-EX2-LL	8,0	1,0	8	2	12,0	100
IMB-10.0-0.5-EX2-LL	10,0	0,5	10	2	15,0	100
IMB-10.0-1.0-EX2-LL	10,0	1,0	10	2	15,0	100
IMB-6.0-1.0-EX2	6,0	1,0	6	2	9,0	63
IMB-8.0-0.5-EX2	8,0	0,5	8	2	12,0	73
IMB-8.0-1.0-EX2	8,0	1,0	8	2	12,0	73
IMB-10.0-0.5-EX2	10,0	0,5	10	2	15,0	73
IMB-10.0-1.0-EX2	10,0	1,0	10	2	15,0	73

All products on these pages come in both TLN and HSN coatings.

Solid Carbide End Mill Program - Bull Nose continued



IMB-4-LL – Z4 Angle 30°

Tool Ordering No.	Cutter Diameter (D1) tol. +0 / -0.01	Corner Radius	Shank Diameter (D2)	No. of Flutes	Cutting Length (L1)	Overall Length (L2)
IMB-2.0-0.5-EX4-LL	2,0	0,5	4	4	3,0	75
IMB-3.0-0.5-EX4-LL	3,0	0,5	6	4	4,5	75
IMB-4.0-0.5-EX4-LL	4,0	0,5	6	4	6,0	75
IMB-5.0-0.5-EX4-LL	5,0	0,5	6	4	7,5	75
IMB-6.0-0.5-EX4-LL	6,0	0,5	6	4	9,0	90
IMB-8.0-0.5-EX4-LL	8,0	0,5	8	4	12,0	100
IMB-10.0-0.5-EX4-LL	10,0	0,5	10	4	15,0	100

Solid Carbide End Mill Program - Toroid

The Toroid Series TOM with large corner radius and slight back taper is a Millstar innovative addition. It is very useful in I.D. and O.D. Z-level and spiral milling at constant tool pressure, pocket milling, and milling of pre-hard and hardened flat surfaces at higher speeds than tools with smaller or sharp corner radii.

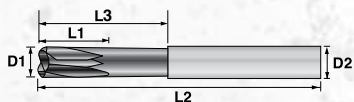

TOM- Toroid

Tool Ordering No.	Cutter Diameter (D1) tol. +0 / -0.01	Corner Radius	Shank Diameter (D2)	No. of Flutes	Neck Diameter	Cutting Length (L1)	Nose Taper	Overall Length (L2)
TOM-2.0	2	0,5	6,0	2	1,84	2,0	6 / 0,75°	63
TOM-3.0	3	0,75	6,0	2	2,76	3,0	9 / 0,75°	63
TOM-4.0	4	1,0	6	2	3,68	4,0	12 / 0,75°	63
TOM-6.0	6	1,5	6	2	5,52	6,0	18 / -	63
TOM-8.0	8	2,0	8	2	7,37	8,0	24 / -	75
TOM-10.0	10	2,5	10	2	9,21	10,0	30 / -	75
TOM-12.0	12	3,0	12	2	11,05	12,0	36 / -	90

All tools backdraft 3° per side

All products on these pages come in both TLN and HSN coatings.

Example: TOM-2.0-TLN



SD Collet & HM Milling Chuck Contents

BT...SD

SD Collet High Accuracy Chucks

120-121



CT...SD



HSK...SD



HM

HM Milling Chucks

120-121



SD Collet Chuck

Measurement System	Interface	Collet Type	Gage Length
Imperial	CT40	SD-16	80mm
Metric	BT40	SD-16	90mm

HM Milling Chuck

Measurement System	Denoted Milling Chuck Size	Collet OD	Gage Length	Interface
Imperial	HM	32mm	4	CAT40
Metric	HM	32mm	105	BT40

SD Collet Chucks

CAT, BT and HSK styles:

- SD design increases gripping power/torque over the traditional ER collet system with 4° per side angle contact.
- Maximum runout (0.007mm @ 4XD) increases accuracy and tool life while minimizing rework. Consistent repeatability shortens set-up time and improves productivity.
- Off the shelf balance specifications of G6.3 at 20,000 rpm provides confidence in high speed machining applications and high accuracy requirements.
- Durable, case hardened chucks.

HM Milling Chucks

CAT, BT and HSK styles:

- More efficient & effective roughing operations.
- Exceptional rigidity under side loads.
- Strong chucking torque eliminates cutting tool slip and maximizes gripping power.
- Decreased vibration extends tool life and improves surface finishes for secondary operations.
- Superior concentric positioning improves accuracy and allows closer to net shape machining.
- Very competitively priced.



SD Collet Chucks

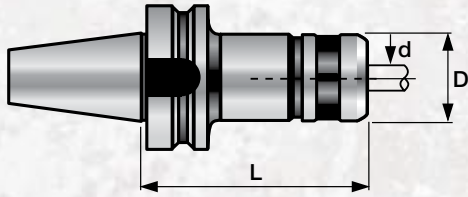

SD Collet Chucks (high accuracy)

Tool Ordering No.	Length L	Diameter D	Clamping Range d	Weight Kg
BT40-SD16-90	90mm	41mm	2,75-16mm	1,3
BT50-SD16-100	100mm	41mm	2,75-16mm	3,2

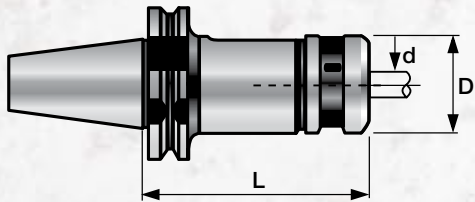

CT40-SD16-80	80mm	41mm	2,75-16mm	1,3
CT50-SD16-100	100mm	41mm	2,75-16mm	3,2

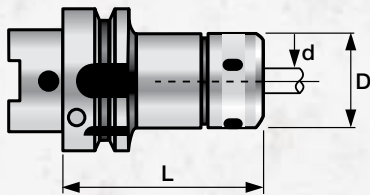

HSK63A-SD16-80	80mm	41mm	2,75-16mm	1,1
HSK100A-SD16-100	100mm	41mm	2,75-16mm	2,5

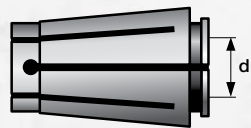

SD Collets

Tool Ordering No.	Range d	Tool Ordering No.	Range d	Tool Ordering No.	Range d	Tool Ordering No.	Range d
SD-16-3	2,5-3,0	SD-16-6,5	6,0-6,5	SD-16-10	9,5-10,0	SD-16-13,5	13,0-13,5
SD-16-3,5	3,0-3,5	SD-16-7	6,5-7,0	SD-16-10,5	10,0-10,5	SD-16-14	13,5-14,0
SD-16-4	3,5-4,0	SD-16-7,5	7,0-7,5	SD-16-11	10,5-11,0	SD-16-14,5	14,0-14,5
SD-16-4,5	4,0-4,5	SD-16-8	7,5-8,0	SD-16-11,5	11,0-11,5	SD-16-15	14,5-15,0
SD-16-5	4,5-5,0	SD-16-8,5	8,0-8,5	SD-16-12	11,5-12,0	SD-16-15,5	15,0-15,5
SD-16-5,5	5,0-5,5	SD-16-9	8,5-9,0	SD-16-12,5	12,0-12,5	SD-16-16	15,5-16,0
SD-16-6	5,5-6,0	SD-16-9,5	9,0-9,5	SD-16-13	12,5-13,0		



SD Clamping Nut

Tool Ordering No.	Length L	Diameter D
SD-16-Nut	24	41



SD Spanner Wrench

Tool Ordering No.	Length L	Diameter D
SD-S-16	170	41

HM Milling Chucks

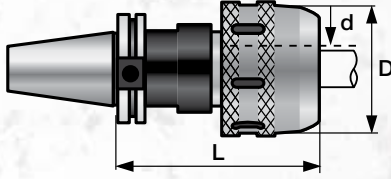

HM Milling Chucks

Tool Ordering No.	Length L	Diameter D	Diameter d	Clamping Range d	Weight Kg	Thread
HM32-4.0-CAT40 (DIN)	102mm	73,4mm	32mm	6-32mm*	2,4	
HM32-4.0-CAT50 (DIN)	102mm	73,4mm	32mm	6-32mm*	4,4	

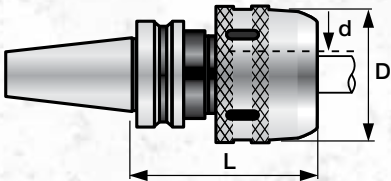

Tool Ordering No.	Length L	Diameter D	Diameter d	Clamping Range d	Weight Kg
HM32-105-BT40	105mm	73,5mm	32mm	6-32mm*	2,4
HM32-105-BT50	105mm	73,5mm	32mm	6-32mm*	5

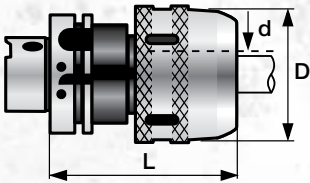

Tool Ordering No.	Length L	Diameter D	Diameter d	Clamping Range d	Weight Kg
HM32-100-HSK63A	100mm	73,5mm	32mm	6-32mm*	2,1
HM32-100-HSK100A	100mm	73,5mm	32mm	6-32mm*	3,4

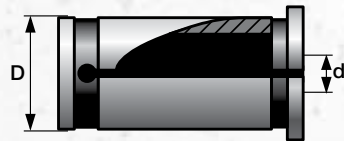

HMC Collets

Tool Ordering No.	Diameter D	Diameter d
HMC-32-6	32mm	6
HMC-32-8	32mm	8
HMC-32-10	32mm	10
HMC-32-12	32mm	12
HMC-32-14	32mm	14
HMC-32-16	32mm	16
HMC-32-18	32mm	18
HMC-32-20	32mm	20
HMC-32-25	32mm	25



HM-S Spanner Wrench

Tool Ordering No.	Length L	Diameter D
HM-S-40	265	70



4930 S. Lapeer Road • Orion Twp., MI 48359 • 1.877.MILLSTAR • www.millstar.com

LIMITED WARRANTY

Millstar Warrants to all distributors and industrial users that the products supplied by Millstar shall be free from defects in material and workmanship.

For a period of thirty days from the date of sale, Millstar will repair or replace (at no additional cost to the customer) any standard Millstar product which Millstar determines contains defects in material or workmanship. Alternately, at its sole discretion, Millstar may credit all or part of the purchase price for such product. However, complete operating conditions and any other information requested by Millstar must accompany claims made under this Warranty. Millstar cannot issue credit or accept returns on special items.

EXCLUSION OF OTHER WARRANTIES AND POLICIES

There are no warranties, express or implied, which extend beyond the warranty description on the face hereof and specifically, MILLSTAR AND ITS AFFILIATED COMPANIES EXCLUDE ANY IMPLIED WARRANTY OF MERCHANTABILITY OR FITNESS FOR A PARTICULAR USE. Millstar and its affiliated companies shall have no liability or responsibility for any claim or loss arising out of design, manufacture, sale or use of its products other than to repair or replace its products as described above. IN NO EVENT SHALL MILLSTAR OR ITS AFFILIATED COMPANIES BE LIABLE FOR ANY SPECIAL, CONSEQUENTIAL OR INCIDENTAL DAMAGES.

Any misuse or alteration of the product will void this Warranty. Millstar does not authorize any person or entity to make any representation (verbal or written) contrary to the terms of this Limited Warranty or its exclusions.



COLE CARBIDE INDUSTRIES, INC.

Cole Oil, Gas & Water
Cole Engineered Products

COLE TOOLING SYSTEMS

Millstar Tooling • Indexa-V Drill Products
OmniThread Thread Milling

